

Price List



Tennsco, LLC
P.O. Box 1888
Dickson, TN 37056-1888
Phone: 800-251-8184
Fax: 800-722-0134
Email: info@tennsco.com

August 2018



PROUDLY MADE IN THE U.S.A.

A Word About Tennsco

Tennsco, LLC, headquartered in Dickson, Tennessee, began operations in 1962. Today, Tennsco is an industry leader in steel storage solutions, with over 1.7 million square feet of manufacturing and warehouse space in nine facilities.

Tennsco offers a wide variety of storage and filing systems, steel office furniture, industrial and institutional shelving, lockers and shop equipment.



Environmentally Friendly Products

Tennsco steel products are certified SCS Indoor Advantage Gold for indoor air quality and low VOC emissions.

Tennsco products allow our customers to apply LEED credits as described below:

- MR Credit 4.1 and 4.2 - Recycled Content
- MR Credit 5.1 - Manufactured Regionally
- MR Credit 5.2 - Extracted and Manufactured Regionally
- EQ Credit 4.2 - Low Emitting Materials, Paints



Available Colors

All Tennsco products have a tough, long lasting powder coated or electrocoated paint finish to ensure years of lasting beauty. Available standard colors vary by product line. All standard color options are listed at the bottom portion of each page, unless otherwise specified.

Standard Colors are available at no additional charge. Premium and Special Matched Colors are available for an upcharge. Finishes shown are representative of the actual finishes. Please contact your local Tennsco dealer for more precise color swatches.

Standard Colors (Unless Otherwise Specified)



Sand (SND) Champagne/ Putty (CPY) Light Grey (LGY) Medium Grey (MGY) Black (BLK)

Quickship Legend

- ◆ - All 5 Standard Colors
- ♠ - Sand, Medium Grey & Black
- ♣ - Medium Grey
- - Black
- - Sand
- ▲ - Sand & Medium Grey
- § - Black & Light Grey
- ▶ - Sand & Light Grey
- ⊖ - Light Grey

Unfinished
Zinc Plated



Items with one of these symbols are part of Tennsco's quick ship program and select colors ship within 2-3 days. Quick ship is subject to maximum order quantities.



Table of Contents

COMMERCIAL

Storage Cabinets	4-12
Bookcases	13-14
Card, Multimedia & Vertical Files	15
Lateral Files	16-17
Add-A-Stack Units & Accessories	18
Literature Sorters, 30 Drawer Organizers, Fixed Shelf Lateral Files & Fixed Shelf Filing Units	19
Imperial Shelving & Doors	20
Regal, Capstone & Commercial Clip Shelving	21

INDUSTRIAL

Lockers	22-38
Z-Line Boltless Shelving & Components	39-48
Automotive Shelving	49
Bulk Storage	50-55
Q-Line Industrial Clip Shelving	56-62
Slotted Angle & Packing Tables	63
Workbenches	64-73
Technical Workstations	74-78

L&T SHELVING

L&T Shelving	79-99
----------------------------------	-----------------------

Product dimensions listed throughout are nominal, actual dimensions may vary. For detailed specifications, contact Tennsco. Freight Classifications listed throughout this price list are subject to change.

POLICY AND SERVICES

PRICING: All prices are F.O.B. Tennsco, LLC's Facility in Dickson, Tennessee. All orders are subject to final acceptance at the Home Office, Dickson, Tennessee. Prices subject to change without notice. Tennsco has the right to make product design changes at any time. Tennsco's prices do not include sales, use, excise or similar taxes. Consequently, in addition to the prices specified herein, the amount of any present or future sales, use, excise or similar tax applicable to the manufacture, sale, purchase or use of the goods sold hereunder shall be paid by Buyer. In lieu thereof, Buyer shall provide Tennsco with a tax exemption certificate acceptable to the applicable taxing authorities.

TERMS OF PAYMENT: Terms are Net 30 Days from date of shipment. A service charge of 1 1/2% per month will be charged for overdue invoices.

MINIMUM ORDERS: Minimum order is \$15.00.

SPECIFICATIONS: Tennsco reserves the right to change any product specifications contained in this price list.

FREIGHT CHARGES: All shipments will be made freight collect unless otherwise specified. If freight is paid by Tennsco, it will be added to the invoice or billed separately, depending on arrangements. On shipments by parcel post, the postage will be added to the invoice. All routing will be done solely by the Home Office. If purchaser does not accept delivery of merchandise when ready for shipment, storage fees will be charged to the purchaser.

WEIGHT: Shipping weights shown are approximate.

FREIGHT CLAIMS: Claims for shortages must be made in writing to the Home Office within 5 business days from receipt of shipment. Claims for damaged or lost material must be filed with the carrier.

CAUTION: When you give delivering carrier a clear receipt for a shipment in which there is damaged merchandise or a shortage, the carrier is relieved of further responsibility. Claims for damage or shortage must be filed by you with the delivering carrier. Tennsco will not accept return of merchandise damaged in transit. Your claim is with the delivering carrier.

CANCELLATIONS & RETURNS: No return merchandise will be accepted or approved, based on product, color and quantity, without written consent of the Tennsco General Office, Dickson, Tennessee. If return is approved, all returned shipments are subject to a handling charge of 25% plus all transportation charges incurred by Tennsco unless Tennsco is at fault. Orders for "Special" items are not subject to change, cancellation or return. Once production of "Special" items has begun, cancellation of order is subject to Tennsco approval. A 15% surcharge will be assessed to approved cancelled items.

LIMITED WARRANTY

Tennsco warrants goods purchased hereunder to be free of defects in materials and workmanship for a period of one (1) year from the date of shipment, hereunder. Tennsco's warranty shall not apply in the event goods are damaged as a result of misuse, abuse, neglect, accident, improper application, modification or repair by persons not authorized by Tennsco, where goods are damaged during shipment. UNLESS CONSIDERED UNENFORCEABLE OR UNLAWFUL UNDER APPLICABLE LAW:

- a. ALL IMPLIED WARRANTIES, INCLUDING BUT NOT LIMITED TO WARRANTIES OR MERCHANTABILITY AND FITNESS FOR A PARTICULAR PURPOSE ARE HEREBY EXCLUDED.
- b. BUYERS REMEDY, IF ANY, FOR ANY DEFECTIVE GOODS SHALL BE LIMITED TO A REFUND BY TENNSCO OR REPLACEMENT OF THE GOODS AT TENNSCO'S OPTION AND SHALL IN NO EVENT INCLUDE DAMAGES OF ANY KIND, WHETHER INCIDENTAL, CONSEQUENTIAL OR OTHERWISE.

NO GOODS ACCEPTED FOR RETURN WITHOUT PRIOR APPROVAL. Tennsco shall have the right to inspect any goods claimed to be defective at Buyer's place of business or require Buyer to return the goods to Tennsco for inspection on Tennsco's premises. Transportation charges covering returned goods will be borne by Tennsco only if such goods are proven to be defective, are covered by this warranty and are returned within the warranty period stated above.

Jumbo & Deluxe Traditional Cabinets

JUMBO TRADITIONAL CABINETS



J1878SU
Solid Doors



CVDJ2478SU
Clear View Doors



JSD1878SU
Sliding Doors

W	D	H	Shelf Load Cap.*	# of Openings	WELDED			UNASSEMBLED		
					CAT. NO.	WT.	PRICE	CAT. NO.	WT.	PRICE
SOLID DOORS										
48	18	30	400	2	J1830SU	103.0	\$608.00	-	-	-
48	18	42	400	2	J1842SU♦	121.0	676.00	J1842A	113.0	538.00
48	24	42	400	2	J2442SU♦	135.0	698.00	J2442A♣	121.0	573.00
48	18	78	400	5	J1878SU♦	203.0	910.00	J1878A-N♦	180.0	746.00
48	24	78	400	5	J2478SU♦	233.0	980.00	J2478A-N♣	208.0	804.00
C-THRU DOORS (Electronic Lock Not Available)										
48	18	42	400	2	CVDJ1842SU	121.0	766.00	-	-	-
48	18	78	400	5	CVDJ1878SU♣	207.0	1,045.00	CVDJ1878A-N	187.0	881.00
48	24	78	400	5	CVDJ2478SU♣	230.0	1,115.00	CVDJ2478A-N	215.0	939.00
SLIDING DOORS (Optional Locks/Padlock Hasp Not Available)										
48	21 1/4	78	400	5	JSD1878SU	228.0	1,280.00	-	-	-
48	27 1/4	78	400	5	JSD2478SU	258.0	1,421.00	-	-	-

Accessories							
Description	W	D	H	Load Cap.	CAT. NO.	WT.	PRICE
EXTRA SHELVES							
Full Width Shelf	48	18	1 5/16	400	306♦	10.6	\$44.00
Full Width Shelf	48	24	1 5/16	400	307♦	14.0	49.00
CASTER KITS							
Fits 48"W x 24"D	48	24	6 11/16	1,000	CK-4824♦	24.0	142.00
PADLOCK HASPS							
Padlock Hasp	-	-	-	-	PLA	1.0	11.00

*Load Capacities are lbs. per shelf, evenly distributed.
 For optional security lock (\$40 List), add "HL" to catalog number.
 For optional electronic lock (\$90 List), add "EL" to catalog number. Only available on welded units.
 For optional keyed alike lock (\$18 List), add "KA" to catalog number.
 For installed padlock hasp (\$6.30 List), add suffix "-HSP" to catalog number for welded units. Padlock hasp must be ordered separately for KD units. Padlock hasp can only be used with double handled doors.

National Motor Freight Class: Welded 175, Unassembled 85

DELUXE TRADITIONAL CABINETS



7818
Solid Doors



7824RH
Solid Doors with
Recessed Handles



CVD7824
Clear View Doors

W	D	H	Shelf Load Cap.*	# of Openings	WELDED			UNASSEMBLED		
					CAT. NO.	WT.	PRICE	CAT. NO.	WT.	PRICE
SOLID DOORS										
36	18	42	200	3	4218DLX♦	90.0	\$526.00	1842♦	90.0	\$408.00
36	24	42	200	3	4224DLX♦	103.0	574.00	2442♦	103.0	445.00
36	18	72	200	5	7218DLX♦	145.0	649.00	-	-	-
36	18	78	200	5	7818♦	157.0	669.00	1870♦	154.0	596.00
36	24	78	200	5	7824♦	178.0	744.00	2470♦	168.0	654.00
SOLID DOORS WITH RECESSED HANDLES (Padlock Hasp Not Available)										
36	18	78	200	5	7818RH	157.0	679.00	1870RH	154.0	606.00
36	24	78	200	5	7824RH	175.0	754.00	2470RH	168.0	664.00
C-THRU DOORS (Electronic Lock Not Available)										
36	18	42	200	3	-	-	-	CVD1842	90.0	498.00
36	24	42	200	3	-	-	-	CVD2442	103.0	535.00
36	18	78	200	5	CVD7818	162.0	804.00	CVD1870	154.0	727.00
36	24	78	200	5	CVD7824	194.0	879.00	CVD2470	183.0	789.00

Accessories							
Description	W	D	H	Load Cap.	CAT. NO.	WT.	PRICE
EXTRA SHELVES							
Full Width Shelf	36	18	1 1/8	200	301♦	8.8	\$28.00
Full Width Shelf	36	24	1 1/8	200	302♦	10.5	37.00
CASTER KITS							
Fits 36"W x 18"D	36	18	6 11/16	1,000	CK18♦	21.0	115.00
Fits 36"W x 24"D	36	24	6 11/16	1,000	CK24♦	23.0	120.00
PADLOCK HASPS							
Padlock Hasp	-	-	-	-	PLA	1.0	11.00

*Load Capacities are lbs. per shelf, evenly distributed.
 For optional security lock (\$40 List), add "HL" to catalog number.
 For optional electronic lock (\$90 List), add "EL" to catalog number. Only available on welded units.
 For optional keyed alike lock (\$18 List), add "KA" to catalog number.
 For installed padlock hasp (\$6.30 List), add suffix "-HSP" to catalog number for welded units. Padlock hasp must be ordered separately for KD units. Padlock hasp can only be used with double handled doors.

National Motor Freight Class: Welded 175, Unassembled 85

Standard Colors



♦ ♣
 Items with these symbols are available to ship in 2-3 days. Limited quantities and select colors.

♦ (SND) (CPY) (LGY) (MGY) (BLK)
 ♣ (SND) (MGY) (BLK)

Standard & Open-Style Traditional Cabinets

STANDARD TRADITIONAL CABINETS

W	D	H	Shelf Load Cap.*	# of Openings	WELDED			UNASSEMBLED		
					CAT. NO.	WT.	PRICE	CAT. NO.	WT.	PRICE
SOLID DOORS										
36	18	30	200	2	3018 ♦	58.0	\$340.00	1430 ♦	51.0	\$265.00
36	18	42	200	3	4218 ♦	79.0	387.00	1442 ♦	74.0	317.00
36	24	42	200	3	4224	88.0	433.00	1420 ♦	85.0	347.00
36	18	60	200	5	6018DH ♣	107.0	522.00	-	-	-
36	24	60	200	5	6024DH ♣	126.0	576.00	-	-	-
30	15	66	200	5	6615 ♣	126.0	566.00	-	-	-
36	18	66	200	5	6618DH ♣	120.0	554.00	-	-	-
36	24	66	200	5	6624DH ♣	136.0	627.00	-	-	-
36	18	72	200	5	7218 ♦	126.0	516.00	1470 ♦	122.0	465.00
36	24	72	200	5	7224 ♦	143.0	592.00	1480 ♦	139.0	534.00
SOLID DOORS WITH RECESSED HANDLES (Padlock Hasp Not Available)										
36	18	72	200	5	7218RH	126.0	536.00	1470RH	122.0	485.00
36	24	72	200	5	7224RH	143.0	612.00	1480RH	139.0	554.00
C-THRU DOORS (Electronic Lock Not Available)										
36	18	42	200	3	CVD4218 ♣	82.0	477.00	CVD1442	69.0	407.00
36	24	42	200	3	CVD4224	97.0	523.00	CVD1420	84.0	422.00
36	18	72	200	5	CVD7218 ♣	136.0	636.00	CVD1470	113.0	585.00
36	24	72	200	5	CVD7224 ♣	153.0	712.00	CVD1480	136.0	654.00



7218
Solid Doors



7218RH
Solid Doors with Recessed Handles



CVD4218
Clear View Doors

Accessories							
Description	W	D	H	Load Cap.	CAT. NO.	WT.	PRICE
EXTRA SHELVES							
Full Width Shelf	36	18	1 1/8	200	301 ♦	8.8	\$28.00
Full Width Shelf	36	24	1 1/8	200	302 ♦	10.5	37.00
CASTER KITS							
Fits 36"W x 18"D	36	18	6 11/16	1,000	CK18 ♦	21.0	115.00
Fits 36"W x 24"D	36	24	6 11/16	1,000	CK24 ♦	23.0	120.00
PADLOCK HASPS							
Padlock Hasp	-	-	-	-	PLA	1.0	11.00

*Load Capacities are lbs. per shelf, evenly distributed.

For optional security lock (\$40 List), add "HL" to catalog number.

For optional electronic lock (\$90 List), add "EL" to catalog number. Only available on WSU units.

For optional keyed alike lock (\$18 List), add "KA" to catalog number.

For installed padlock hasp (\$6.30 List), add suffix "-HSP" to catalog number for welded units. Padlock hasp must be ordered separately for KD units. Padlock hasp can only be used with double handled doors.

National Motor Freight Class: Welded 175, Unassembled 85

OPEN-STYLE TRADITIONAL CABINETS

W	D	H	Shelf Load Cap.*	# of Openings	WELDED		
					CAT. NO.	WT.	PRICE
OPEN STYLE							
36	18	42	200	3	OS4218	66.0	\$301.00
36	24	42	200	3	OS4224	85.0	353.00
48	18	42	400	2	JO1842SU	108.0	468.00
48	24	42	400	2	JO2442SU	118.0	498.00
36	18	72	200	5	OS7218	107.0	408.00
36	24	72	200	5	OS7224	124.0	476.00
48	18	78	400	5	JO1878SU	167.0	644.00
48	24	78	400	5	JO2478SU	197.0	685.00

Accessories							
Description	W	D	H	Load Cap.	CAT. NO.	WT.	PRICE
EXTRA SHELVES							
Full Width Shelf	36	18	1 1/8	200	301 ♦	8.8	\$28.00
Full Width Shelf	36	24	1 1/8	200	302 ♦	10.5	37.00
Full Width Shelf	48	18	1 5/16	400	306 ♦	10.6	44.00
Full Width Shelf	48	24	1 5/16	400	307 ♦	14.0	49.00
CASTER KITS							
Fits 36"W x 18"D	36	18	6 11/16	1,000	CK18 ♦	21.0	115.00
Fits 36"W x 24"D	36	24	6 11/16	1,000	CK24 ♦	23.0	120.00
Fits 48"W x 24"D	48	24	6 11/16	1,000	CK-4824 ♦	24.0	142.00

*Load Capacities are lbs. per shelf, evenly distributed.



JO1878SU
Open Style Jumbo



OS4218
Open Style Counter Height

National Motor Freight Class: Welded 175, Unassembled 85

Standard Colors



♦ ♣
Items with these symbols are available to ship in 2-3 days. Limited quantities and select colors.

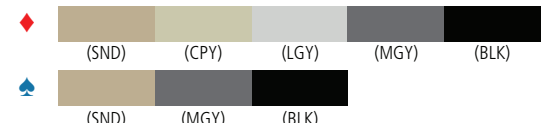

Jumbo & Deluxe Wardrobe Cabinets

JUMBO WARDROBE CABINETS

W	D	H	Shelf Load Cap.*	# of Openings	WELDED			UNASSEMBLED		
					CAT. NO.	WT.	PRICE	CAT. NO.	WT.	PRICE
SOLID DOORS										
48	18	78	400	2	J1878SUW	191.0	\$845.00	J1878A-N-W	173.0	\$691.00
48	24	78	400	2	J2478SUW	217.0	917.00	J2478A-N-W	199.0	715.00



J1878SUW
Solid Doors

National Motor Freight Class: Welded 175, Unassembled 85

Accessories							
Description	W	D	H	Load Cap.	CAT. NO.	WT.	PRICE
EXTRA SHELVES							
Full Width Shelf	48	18	1 5/16	400	306 ♦	10.6	\$44.00
Full Width Shelf	48	24	1 5/16	400	307 ♦	14.0	49.00
CASTER KITS							
Fits 48"W x 24"D	48	24	6 11/16	1,000	CK-4824 ♦	24.0	142.00

*Load Capacities are lbs. per shelf, evenly distributed.

For optional security lock (\$40 List), add "HL" to catalog number.

For optional electronic lock (\$90 List), add "EL" to catalog number. Only available on WSU units.

For optional keyed alike lock (\$18 List), add "KA" to catalog number.

For installed padlock hasp (\$6.30 List), add suffix "-PLA" to catalog number for WSU units. Padlock hasp must be ordered separately for KD units. Padlock hasp can only be used with double handled doors.



CK-4824
Caster Kit

DELUXE WARDROBE CABINETS

W	D	H	Shelf Load Cap.*	# of Openings	WELDED			UNASSEMBLED		
					CAT. NO.	WT.	PRICE	CAT. NO.	WT.	PRICE
SOLID DOORS										
36	18	78	200	2	7818W ♣	134.0	\$615.00	1871 ♣	140.0	\$531.00
36	24	78	200	2	7824W ♣	154.0	674.00	2471 ♣	155.0	573.00
C-THRU DOORS (Electronic Lock Not Available)										
36	18	78	200	2	CVD7818W	140.0	750.00	CVD1871	140.0	666.00
36	24	78	200	2	CVD7824W	164.0	809.00	CVD2471	155.0	708.00



7818W
Solid Doors

National Motor Freight Class: Welded 175, Unassembled 85

Accessories							
Description	W	D	H	Load Cap.	CAT. NO.	WT.	PRICE
EXTRA SHELVES							
Full Width Shelf	36	18	1 1/8	200	301 ♦	8.8	\$28.00
Full Width Shelf	36	24	1 1/8	200	302 ♦	10.5	37.00
CASTER KITS							
Fits 36"W x 18"D	36	18	6 11/16	1,000	CK18 ♦	21.0	115.00
Fits 36"W x 24"D	36	24	6 11/16	1,000	CK24 ♦	23.0	120.00

*Load Capacities are lbs. per shelf, evenly distributed.

For optional security lock (\$40 List), add "HL" to catalog number.

For optional electronic lock (\$90 List), add "EL" to catalog number. Only available on WSU units.

For optional keyed alike lock (\$18 List), add "KA" to catalog number.

For installed padlock hasp (\$6.30 List), add suffix "-PLA" to catalog number for WSU units. Padlock hasp must be ordered separately for KD units. Padlock hasp can only be used with double handled doors.



PLA
Installed Padlock Hasp

Standard Colors



♦ ♣
Items with these symbols are available to ship in 2-3 days. Limited quantities and select colors.

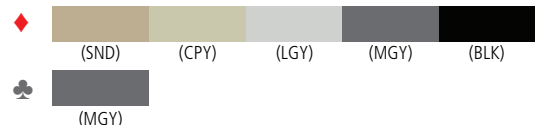

Standard & Open-Style Wardrobe Cabinets

STANDARD WARDROBE CABINETS

W	D	H	Shelf Load Cap.*	# of Openings	WELDED			UNASSEMBLED		
					CAT. NO.	WT.	PRICE	CAT. NO.	WT.	PRICE
SOLID DOORS										
36	18	72	200	2	7114 ♦	107.0	\$475.00	1471 ♦	100.0	\$420.00
36	24	72	200	2	7124 ♦	138.0	532.00	-	-	-
C-THRU DOORS (Electronic Lock Not Available)										
36	18	72	200	2	CVD7114	111.0	595.00	CVD1471	99.0	540.00

Accessories							
Description	W	D	H	Load Cap.	CAT. NO.	WT.	PRICE
EXTRA SHELVES							
Full Width Shelf	36	18	1 1/8	200	301 ♦	8.8	\$28.00
Full Width Shelf	36	24	1 1/8	200	302 ♦	10.5	37.00
CASTER KITS							
Fits 36"W x 18"D	36	18	6 11/16	1,000	CK18 ♦	21.0	115.00
Fits 36"W x 24"D	36	24	6 11/16	1,000	CK24 ♦	23.0	120.00

*Load Capacities are lbs. per shelf, evenly distributed.

For optional security lock (\$40 List), add "HL" to catalog number.

For optional electronic lock (\$90 List), add "EL" to catalog number. Only available on WSU units.

For optional keyed alike lock (\$18 List), add "KA" to catalog number.



CK-18
Caster Kit

7114
Solid Doors



National Motor Freight Class: Welded 175, Unassembled 85

OPEN-STYLE WARDROBE CABINETS

W	D	H	Shelf Load Cap.*	# of Openings	WELDED		
					CAT. NO.	WT.	PRICE
OPEN STYLE							
36	18	72	200	2	OS7114	82.0	\$391.00
36	24	72	200	2	OS7124	119.0	436.00
48	18	78	400	2	JO1878SUW	155.0	630.00
48	24	78	400	2	JO2478SUW	181.0	675.00

Accessories							
Description	W	D	H	Load Cap.	CAT. NO.	WT.	PRICE
EXTRA SHELVES							
Full Width Shelf	36	18	1 1/8	200	301 ♦	8.8	\$28.00
Full Width Shelf	36	24	1 1/8	200	302 ♦	10.5	37.00
Full Width Shelf	48	18	1 5/16	400	306 ♦	10.6	44.00
Full Width Shelf	48	24	1 5/16	400	307 ♦	14.0	49.00
CASTER KITS							
Fits 36"W x 18"D	36	18	6 11/16	1,000	CK18 ♦	21.0	115.00
Fits 36"W x 24"D	36	24	6 11/16	1,000	CK24 ♦	23.0	120.00
Fits 48"W x 24"D	48	24	6 11/16	1,000	CK-4824 ♦	24.0	142.00

*Load Capacities are lbs. per shelf, evenly distributed.

OS7124
Open Style



National Motor Freight Class: Welded 175, Unassembled 85

Standard Colors



♦ Items with this symbol are available to ship in 2-3 days. Limited quantities and select colors.



Jumbo & Deluxe Combination Cabinets

JUMBO COMBINATION CABINETS

W	D	H	SHELF CAPACITY*		# of Openings	WELDED			UNASSEMBLED		
			Full Width	Half Width		CAT. NO.	WT.	PRICE	CAT. NO.	WT.	PRICE
SOLID DOORS											
48	18	78	400	75	7	J1878SUC	203.0	\$960.00	J1878C-N	193.0	\$744.00
48	24	78	400	75	7	J2478SUC ♦	230.0	1,039.00	J2478C-N	213.0	803.00



J1878SUC
Solid Doors

National Motor Freight Class: Welded 175, Unassembled 85

Accessories							
Description	W	D	H	Load Cap.	CAT. NO.	WT.	PRICE
EXTRA SHELVES							
Full Width Shelf	48	18	1 5/16	400	306 ♦	10.6	\$44.00
Full Width Shelf	48	24	1 5/16	400	307 ♦	14.0	49.00
Half Width Shelf	24	18	3/4	75	JPS18	3.9	30.00
Half Width Shelf	24	24	3/4	75	JPS24	5.2	35.00
CASTER KITS							
Fits 48"W x 24"D	48	24	6 11/16	1,000	CK-4824 ♦	23.0	142.00

*Load Capacities are lbs. per shelf, evenly distributed.

For optional security lock (\$40 List), add "HL" to catalog number.

For optional electronic lock (\$90 List), add "EL" to catalog number. Only available on WSU units.

For optional keyed alike lock (\$18 List), add "KA" to catalog number.

For installed padlock hasp (\$6.30 List), add suffix "-PLA" to catalog number for WSU units. Padlock hasp must be ordered separately for KD units. Padlock hasp can only be used with double handled doors.

DELUXE COMBINATION CABINETS

W	D	H	SHELF CAPACITY*		# of Openings	WELDED			UNASSEMBLED		
			Full Width	Half Width		Cat. No.	Wt.	Price	CAT. NO.	WT.	PRICE
SOLID DOORS											
36	18	78	200	75	7	7814 ♦	156.0	\$714.00	1872 ♦	152.0	\$614.00
36	24	78	200	75	7	7820 ♦	178.0	790.00	2472 ♦	181.0	672.00
C-THRU DOORS (Electronic Lock Not Available)											
36	18	78	200	75	7	CVD7814	160.0	849.00	CVD1872	152.0	749.00
36	24	78	200	75	7	CVD7820	192.0	925.00	CVD2472	181.0	807.00



7814
Solid Doors

National Motor Freight Class: Welded 175, Unassembled 85

Accessories							
Description	W	D	H	Load Cap.	CAT. NO.	WT.	PRICE
EXTRA SHELVES							
Full Width Shelf	36	18	1 1/8	200	301 ♦	8.8	\$28.00
Full Width Shelf	36	24	1 1/8	200	302 ♦	10.5	37.00
Half Width Shelf	18	18	3/4	75	304 ♦	4.0	17.20
Half Width Shelf	18	24	3/4	75	305 ♦	5.8	19.80
CASTER KITS							
Fits 36"W x 18"D	36	18	6 11/16	1,000	CK18 ♦	21.0	115.00
Fits 36"W x 24"D	36	24	6 11/16	1,000	CK24 ♦	23.0	120.00

*Load Capacities are lbs. per shelf, evenly distributed.

For optional security lock (\$40 List), add "HL" to catalog number.

For optional electronic lock (\$90 List), add "EL" to catalog number. Only available on WSU units.

For optional keyed alike lock (\$18 List), add "KA" to catalog number.

For installed padlock hasp (\$6.30 List), add suffix "-PLA" to catalog number for WSU units. Padlock hasp must be ordered separately for KD units. Padlock hasp can only be used with double handled doors.

Standard Colors



♦ Items with this symbol are available to ship in 2-3 days. Limited quantities and select colors.



Standard & Open-Style Combination Cabinets

STANDARD COMBINATION CABINETS

W	D	H	SHELF CAPACITY*		# of Openings	WELDED			UNASSEMBLED		
			Full Width	Half Width		CAT. NO.	WT.	PRICE	CAT. NO.	WT.	PRICE
SOLID DOORS											
36	24	66	200	75	7	6620DH	135.0	\$649.00	-	-	-
36	18	72	200	75	7	7214♦	125.0	546.00	1472♦	123.0	479.00
36	24	72	200	75	7	7220♦	143.0	647.00	1482♣	149.0	538.00
C-THRU DOORS (Electronic Lock Not Available)											
36	18	72	200	75	7	CVD7214	132.0	666.00	CVD1472	112.0	599.00
36	24	72	200	75	7	CVD7220	155.0	767.00	-	-	-

Accessories							
Description	W	D	H	Load Cap.	CAT. NO.	WT.	PRICE
EXTRA SHELVES							
Full Width Shelf	36	18	1 1/8	200	301♦	8.8	\$28.00
Full Width Shelf	36	24	1 1/8	200	302♦	10.5	37.00
Half Width Shelf	18	18	3/4	75	304♦	4.0	17.20
Half Width Shelf	18	24	3/4	75	305♦	5.8	19.80
CASTER KITS							
Fits 36"W x 18"D	36	18	6 11/16	1,000	CK18♦	21.0	115.00
Fits 36"W x 24"D	36	24	6 11/16	1,000	CK24♦	23.0	120.00

*Load Capacities are lbs. per shelf, evenly distributed.
 For security lock (\$40 List), add "HL" to catalog number.
 For optional electronic lock (\$90 List), add "EL" to catalog number. Only available on WSU units.
 For optional keyed alike lock (\$18 List), add "KA" to catalog number.



7220
Solid Doors

National Motor Freight Class: Welded 175, Unassembled 85

OPEN-STYLE COMBINATION CABINETS

W	D	H	SHELF CAPACITY*		# of Openings	WELDED		
			Full Width	Half Width		CAT. NO.	WT.	PRICE
OPEN STYLE								
36	18	72	200	75	7	OS7214	106.0	\$463.00
36	24	72	200	75	7	OS7220	124.0	524.00
48	18	78	400	75	7	JO1878SUC	167.0	698.00
48	24	78	400	75	7	JO2478SUC	197.0	763.00

Accessories							
Description	W	D	H	Load Cap.	CAT. NO.	WT.	PRICE
EXTRA SHELVES							
Full Width Shelf	36	18	1 1/8	200	301♦	8.8	\$28.00
Full Width Shelf	36	24	1 1/8	200	302♦	10.5	37.00
Half Width Shelf	18	18	3/4	75	304♦	4.0	17.20
Half Width Shelf	18	24	3/4	75	305♦	5.8	19.80
Full Width Shelf	48	18	1 5/16	400	306♦	10.6	44.00
Full Width Shelf	48	24	1 5/16	400	307♦	14.0	49.00
Half Width Shelf	24	18	3/4	75	JPS18	3.9	30.00
Half Width Shelf	24	24	3/4	75	JPS24	5.2	35.00
CASTER KITS							
Fits 36"W x 18"D	36	18	6 11/16	1,000	CK18♦	21.0	115.00
Fits 36"W x 24"D	36	24	6 11/16	1,000	CK24♦	23.0	120.00
Fits 48"W x 24"D	48	24	6 11/16	1,000	CK-4824♦	24.0	142.00

*Load Capacities are lbs. per shelf, evenly distributed.



OS7220
Open Style

National Motor Freight Class: Welded 175, Unassembled 85

Standard Colors



♦ ♣
 Items with these symbols are available to ship in 2-3 days. Limited quantities and select colors.

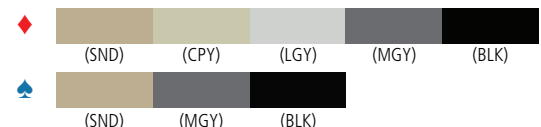

Specialty Cabinets

JANITORIAL CABINET



			Shelf	# of	WELDED		
W	D	H	Load Cap.*	Openings	CAT. NO.	WT.	PRICE
36	18	64	75	4	JAN6618DH♦	99.0	\$569.00
36	18	64	75	4	JAN6618DHEL**	99.0	659.00
36	18	64	75	4	JAN6618DH-PLA♣	99.0	575.30

*Load Capacities are lbs. per shelf, evenly distributed.

**With installed electronic lock.

♣With installed padlock hasp.

National Motor Freight Class: 175

STORAGE CABINET/BOOKCASE COMBINATION



			Shelf	# of	WELDED		
W	D	H	Load Cap.*	Openings	CAT. NO.	WT.	PRICE
36	18	72	200	5	BCD18-72♦	122.0	\$567.00
EXTRA SHELF							
36	18	1 1/8	200	-	301♦	8.8	28.00

*Load Capacities are lbs. per shelf, evenly distributed.

National Motor Freight Class: 175

STORAGE CABINET WITH FILE DRAWERS



			Shelf	# of	WELDED		
W	D	H	Load Cap.*	Openings	CAT. NO.	WT.	PRICE
WITH ONE BOTTOM FILE DRAWER							
36	18	42	200	2	DWR-4218♠	94.0	\$649.00
36	18	66	200	4	DWR-6618♠	135.0	777.00
WITH TWO BOTTOM FILE DRAWERS							
36	18	72	200	3	DWR-7218-2	150.0	1,160.00

Accessories**							
Description	W	D	H	CAT. NO.	WT.	PRICE	
Cross Rods (Pair)	15 3/4	1 7/16	7/8	15CR	1.0	\$9.30	

*Load Capacities are lbs. per shelf, evenly distributed.

**Cross Rods (15CR) only available in Black.

Load capacities up to 120 lbs. per drawer.

All units are setup. Lateral drawers ship standard with file rods for side-to-side filing applications. For front-to-back filing, drawers will accommodate two rows of letter-sized or legal-sized files. This requires one pair of cross rods (15CR) per drawer.

Same key opens both the cabinet lock and the drawer lock.

Can not be used with caster kits.

National Motor Freight Class: 175

Standard Colors



Sand (SND) Champagne/ Putty (CPY) Light Grey (LGY) Medium Grey (MGY) Black (BLK)

♦ ♠
Items with these symbols are available to ship in 2-3 days. Limited quantities and select colors.

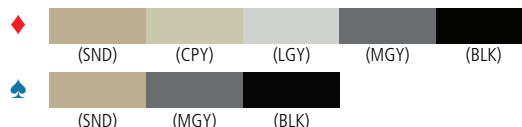

Specialty Cabinets

MOBILE TRADITIONAL CABINETS

WELDED								
W	D	H	Load Cap.*	# of Openings	CAT. NO.	WT.	PRICE	
36	18	36 3/4	200	2	CK3018	79.0	\$465.00	
36	24	36 3/4	200	2	CK3024	85.0	497.00	
36	18	78 3/4	200	5	CK7218	141.0	641.00	
36	24	78 3/4	200	5	CK7224	158.0	722.00	
36	18	84 3/4	200	5	CK7818	171.0	794.00	
36	24	84 3/4	200	5	CK7824	190.0	874.00	

Accessories							
Description	W	D	H	Load Cap.*	CAT. NO.	WT.	PRICE
EXTRA SHELVES							
Full Width Shelf	36	18	1 1/8	200	301♦	8.8	\$28.00
Full Width Shelf	36	24	1 1/8	200	302♦	10.5	37.00

*Load Capacities are lbs. per shelf, evenly distributed.

National Motor Freight Class: 175



LAPTOP/TABLET CHARGING STATIONS

WELDED								
W	D	H	Mobile?	# of Openings	CAT. NO.	WT.	PRICE	
42" HIGH CABINET WITH 16 CHARGING STATIONS								
36	24	42	No	17	4224-CMP	97.0	\$1,161.00	
36	24	48 3/4	Yes	17	4224-CMPM	118.0	1,300.00	
72" HIGH CABINET WITH 32 CHARGING STATIONS								
36	24	72	No	33	7224-CMP	282.0	2,118.00	
36	24	78 3/4	Yes	33	7224-CMPM	303.0	2,224.00	

Power outlets must only be used for charging low-amperage devices (such as laptop computers, notebooks, tablets, etc.) to prevent power overload. Maximum amp load is 15 amps per 16-outlet strip.

Welded, set-up units. 72" high units include a center pull-out reference shelf.

Mobile units include two swivel and two fixed casters.

National Motor Freight Class: 175



CABINETS WITH PERFORATED DOORS

WELDED								
W	D	H	Shelf Load Cap.*	# of Openings	CAT. NO.	WT.	PRICE	
STANDARD CABINETS WITH PERFORATED DOORS								
36	18	72	200	5	7218-PD	125.0	\$536.00	
36	24	72	200	5	7224-PD	142.0	612.00	
JUMBO CABINETS WITH PERFORATED DOORS								
48	18	78	400	5	J1878SU-PD	201.0	930.00	
48	24	78	400	5	J2478SU-PD	231.0	1,000.00	

*Load Capacities are lbs. per shelf, evenly distributed.

National Motor Freight Class: 175



Standard Colors



♦ Items with this symbol are available to ship in 2-3 days. Limited quantities and select colors.

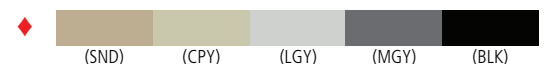

Specialty Cabinets

CANTILEVERED BIN STORAGE CABINETS



				WELDED		
W	D	H	Bin Rails Included	CAT. NO.	WT.	PRICE
36	18	78	8	7818BC	216.0	\$977.00
36	24	78	8	7824BC	240.0	986.00

Accessories						
Description	W	D	H	CAT. NO.	WT.	PRICE
Additional Bin Rails	36	3/4	1 1/2	CBR-36	2.0	11.00

Storage bins are not included and are not sold by Tensco.
Bins may be up to 15" deep in 18"d cabinets, and up to 18" deep in 24"d cabinets.
Bin loaded weights must not exceed 30 lbs per rail.

National Motor Freight Class: 175

TA-50 MILITARY CABINET



				WELDED			
W	D	H	Load Cap.*	# of Openings	CAT. NO.	WT.	PRICE
TA-50 Cabinet With Standard Handle							
42	24	78	400	2	TA-50	290.0	\$1,352.00
TA-50 Cabinet With Heavy-Duty Handle							
42	24	78	400	2	TA-50HH	295.0	1,507.00
Extra Shelf							
42	24	1 3/4	400	-	TA-50ES	20.0	107.00

*Load Capacities are lbs. per shelf, evenly distributed.

National Motor Freight Class: 175

SINGLE DOOR CABINET



				WELDED			
W	D	H	Load Cap.*	# of Openings	CAT. NO.	WT.	PRICE
Single Door Cabinet							
19	24	30	75	2	1824♣	53.0	\$350.00
Extra Shelf							
19	24	3/4	75	-	309	5.9	31.00

*Load Capacities are lbs. per shelf, evenly distributed.

National Motor Freight Class: 175

Standard Colors



Items with this symbol are available to ship in 2-3 days. Limited quantities and select colors.



Welded Bookcases

CAT. NO.	NO. OF OPENINGS	W	D	H	WT.	PRICE
34 1/2" Wide Bookcases						
B-30♦	2	34 1/2	13 1/2	28	40.0	\$187.00
B-42♦	3	34 1/2	13 1/2	40	57.0	225.00
B-53♦	4	34 1/2	13 1/2	52	70.0	287.00
B-66♦	5	34 1/2	13 1/2	66	90.0	338.00
B-78♦	6	34 1/2	13 1/2	78	105.0	377.00
Extra Shelf for 34 1/2" Wide						
B-345♦	—	34 1/2	13 1/2	1	7.6	25.00
30" Wide Bookcases						
BC30-29	2	30	13 1/2	29	33.0	211.00
BC30-42	3	30	13 1/2	42	45.0	252.00
BC30-48	4	30	13 1/2	48	47.0	291.00
BC30-60	5	30	13 1/2	60	57.0	357.00
BC30-66	6	30	13 1/2	66	90.0	365.00
Extra Shelf for 30" Wide						
BC30-345	—	30	13 1/2	3/4	5.9	32.00
Accessories						
CAT. NO.	W	D	H	WT.	PRICE	
BOOK SUPPORTS						
BSN6	4 1/2	1 3/4	6	0.6	\$6.80	
BSN9	4 1/2	1 3/4	9	1.1	8.20	

WELDED BOOKCASES — 13 1/2" DEEP



13 1/2 depth is ideal for storing books and standard sized binders.
Available in 34 1/2" and 30" widths
Shelf capacities up to 130 lbs. per shelf, evenly distributed
National Motor Freight Class: 175

CAT. NO.	NO. OF OPENINGS	W	D	H	WT.	PRICE
18" Deep Bookcases						
BC18-30●	2	36	18	30	47.0	\$273.00
BC18-42●	3	36	18	43	66.0	337.00
BC18-52●	4	36	18	55	80.0	395.00
BC18-72●	5	36	18	72	107.0	485.00
BC18-84●	6	36	18	84	122.0	520.00
Extra Shelf						
301♦	—	36	18	3/4	8.2	28.00
18" Deep Mobile Bookcases						
BC18-30M	2	36	18	36 1/2	68.0	398.00
BC18-42M	3	36	18	49 1/2	81.0	462.00
BC18-52M	4	36	18	61 1/2	101.0	520.00
BC18-72M	5	36	18	78 1/2	118.0	610.00
Laminate Top*						
LT-3618		36	18	5/8	15.0	59.00
Accessories						
CAT. NO.	W	D	H	WT.	PRICE	
BOOK SUPPORTS						
BSN6	4 1/2	1 3/4	6	0.6	\$6.80	
BSN9	4 1/2	1 3/4	9	1.1	8.20	

WELDED BOOKCASES — 18" DEEP



Great for storing items with a larger profile; also has a raised base and can be fitted with casters for mobility.
Shelf capacities up to 150 lbs. per shelf, evenly distributed
National Motor Freight Class: 175

CAT. NO.	NO. OF SHELVES	W	D	H	WT.	PRICE
With Glass Doors (Lock Included)						
330GL●	2	36	15	30	78.0	\$605.00
342GL●	3	36	15	42	105.0	697.00
352GL●	4	36	15	52	130.0	753.00
Without Glass Doors						
330	2	36	15	30	60.0	389.00
342	3	36	15	42	78.0	428.00
352	4	36	15	52	95.0	472.00
Glass Door Kits (Lock Included)						
330GDK	—	—	—	—	22.0	213.00
342GDK	—	—	—	—	33.0	241.00
352GDK	—	—	—	—	39.0	293.00
Extra Shelves*						
GBS-36	—	36	13 1/2	1	9.9	26.00
Accessories						
CAT. NO.	W	D	H	WT.	PRICE	
BOOK SUPPORTS						
BSN6	4 1/2	1 3/4	6	0.6	\$6.80	
BSN9	4 1/2	1 3/4	9	1.1	8.20	

EXECUTIVE BOOKCASES



Shelf capacities up to 150 lbs. per shelf, evenly distributed.
National Motor Freight Class:
Welded Bookcases with or without doors: 175
Glass doors only: 77.5

*Extra shelves packed 2 per carton, priced per each.

Standard Colors



♦ ●
Items with these symbols are available to ship in 2-3 days. Limited quantities and select colors.

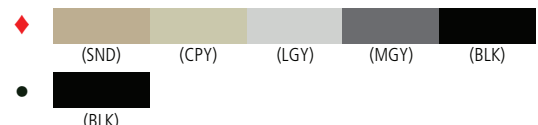

Unassembled Bookcases

UNASSEMBLED BOOKCASES

BOOKCASES



B-3000
30"H Bookcase



B-4200
42"H Bookcase



B-6000
60"H Bookcase



B-8400
84"H Bookcase

CAT. NO.	NO. OF OPENINGS	END PANELS	W	D	H	WT.	PRICE
30" H Bookcases							
B-3000 •	2	YES	38	12	30	57.0	\$296.00
B-3001	2	NO	38	12	30	45.0	273.00
Extra Shelf							
B-12 •	—	—	36	12	7/8	7.9	37.00
Shelf Divider							
B-1 •	—	—	—	10	7	1.2	3.70

CAT. NO.	NO. OF OPENINGS	END PANELS	W	D	H	WT.	PRICE
42" H Bookcases							
B-4200 •	3	YES	38	12	42	79.0	\$329.00
B-4201	3	NO	38	12	42	68.0	308.00
Extra Shelf							
B-12 •	—	—	36	12	7/8	7.9	37.00
Shelf Divider							
B-1 •	—	—	—	10	7	1.2	3.70

CAT. NO.	NO. OF OPENINGS	END PANELS	W	D	H	WT.	PRICE
60" H Bookcases							
B-6000 •	5	YES	38	12	60	119.0	\$469.00
B-6001	5	NO	38	12	60	103.0	417.00
Extra Shelf							
B-12 •	—	—	36	12	7/8	7.9	37.00
Shelf Divider							
B-1 •	—	—	—	10	7	1.2	3.70

CAT. NO.	NO. OF OPENINGS	END PANELS	W	D	H	WT.	PRICE
84" H Bookcases							
B-8400 •	7	YES	38	12	84	160.0	\$596.00
B-8401	7	NO	38	12	84	138.0	533.00
Extra Shelf							
B-12 •	—	—	36	12	7/8	7.9	37.00
Shelf Divider							
B-1 •	—	—	—	10	7	1.2	3.70

All units have backs. All units come standard with one divider per opening.
End panels are required only at ends of row.
Order one unit with end panels, then add-on units without end panels.
Shelf capacities up to 200 lbs. per shelf, evenly distributed.
National Motor Freight Class: 85

BOOK SUPPORTS



BSN6



BSN9

CAT. NO.	W	D	H	WT.	PRICE
BSN6	4 1/2	1 3/4	6	0.6	\$6.80
BSN9	4 1/2	1 3/4	9	1.1	8.20

Sold individually, not as pairs.

National Motor Freight Class: 85

Standard Colors



• Items with this symbol are available to ship in 2-3 days. Limited quantities and select colors.



(BLK)

CARD & MULTIMEDIA FILES

CAT. NO.	NO. OF DRAWERS	W	D	H	WT.	PRICE
Card Files						
CF-558	5	19	28	40 7/16	165.0	\$1,277.00
CF-669♦	6	21	28	52 3/8	214.0	1,499.00
CF-646	6	15	28	40 7/16	170.0	1,342.00
CF-758♦	7	19	28	52 3/8	220.0	1,560.00
CF-846♦	8	15	28	52 3/8	216.0	1,644.00
Extra Center Partition						
CF-DIV	(Available in Black Only)				1.0	16.80
Extra Follower Block						
CF-BLK1	(For all sizes except CF-669)				0.5	4.10
CF-BLK2	(For CF-669 only)				0.5	5.40

Card files come standard with one center partition and two follower blocks. Units come standard with four levelers for uneven floors.

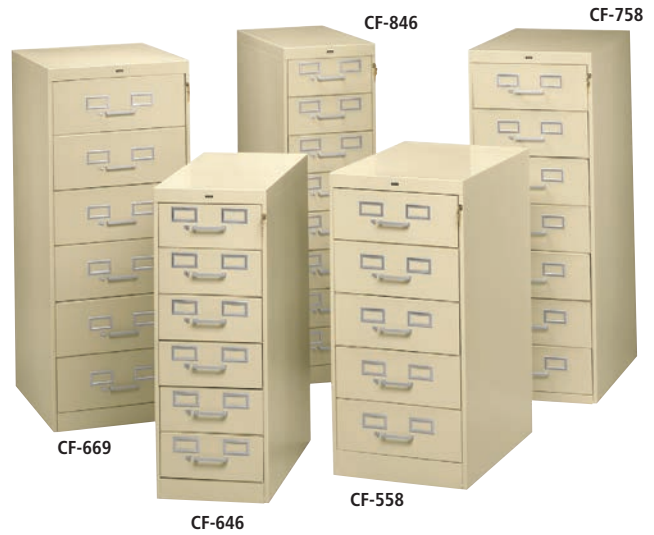

FILING SYSTEMS

STORAGE CAPACITIES FOR VARIOUS MEDIA					
CAT. NO.	CARDS		CDs	CDs	DVD/Blu-Rays
	(Sizes)	(Cap.)	(Standard)	(Slimline)	(Movie Case)
CF-558	5x8	27,200	640*	1200	420
CF-669	6x9	32,600			504**
CF-646	3x5; 4x6	32,600	768	1440	
CF-758	5x8	38,100	896*	1680*	588
CF-846	3x5; 4x6	43,400	1024	1920	

*Removing center partition increases this number by 1/3.

**DVD/Blu-Rays fit securely when a second center partition (CF-DIV) is inserted.

National Motor Freight Class: 175

VERTICAL FILES

Product Specifications

- Full suspension drawers feature three-member, ball-bearing suspensions.
- Mechanical inner lock allows only one drawer to be open at a time to prevent tipping.
- Four adjustable steel leveling glides.
- High sided drawers eliminate need for hanging folder rods.
- One label holder per drawer.
- Steel follower block in all drawers slide in a recessed metal track.

Lock Specifications

- One key unlocks all drawers at once.
- Locks are core-removable.
- Locks are keyed randomly. For keyed alike, add suffix "-KA" to model number.
- Lateral Files, Vertical Files, and Card Files can be keyed alike if desired.

CAT. NO.	DESCRIPTION	W	D	H	WT.	PRICE
Two Drawer Vertical Files						
V282-MF	Letter Size, 2 Drawer	14 15/16	28	26 15/16	80.0	\$569.00
V282C-MF	Legal Size, 2 Drawer	17 15/16	28	26 15/16	86.0	606.00
Three Drawer Vertical Files						
V283-MF	Letter Size, 3 Drawer	14 15/16	28	38 3/4	113.0	719.00
V283C-MF	Legal Size, 3 Drawer	17 15/16	28	38 3/4	120.0	771.00
Four Drawer Vertical Files						
V284-MF	Letter Size, 4 Drawer	14 15/16	28	50 9/16	144.0	879.00
V284C-MF	Legal Size, 4 Drawer	17 15/16	28	50 9/16	154.0	929.00
Five Drawer Vertical Files						
V285-MF	Letter Size, 5 Drawer	14 15/16	28	62 3/8	176.0	1,020.00
V285C-MF	Legal Size, 5 Drawer	17 15/16	28	62 3/8	187.0	1,085.00

National Motor Freight Class: 175



Standard Colors



♦ Items with this symbol are available to ship in 2-3 days. Limited quantities and select colors.



Product Specifications

- Full suspension drawers feature three-member, steel ball-bearing suspensions with a limited lifetime warranty.
- Standard dual-point gang lock with safety interlock system.
- One label holder per drawer.
- Four adjustable steel leveling glides.
- All drawers and shelves equipped with standard hanging folder rods for side-to-side letter or legal filing. For filing front-to-back, order cross rods (15CR).

TWO DRAWER LATERAL FILES



National Motor Freight Class: 150

CAT. NO.	DESCRIPTION	W	D	H	WT.	PRICE
LPL3024L20	30" File, Fixed Drawer Fronts	30	17 15/16	27 9/16	97.0	\$746.00
LPL3024L21	30" File, Retractable Doors	30	17 15/16	27 9/16	101.0	887.00
LPL3624L20	• 36" File, Fixed Drawer Fronts	36	17 15/16	27 9/16	108.0	739.00
LPL3624L21	• 36" File, Retractable Doors	36	17 15/16	27 9/16	112.0	848.00
LPL4224L20	• 42" File, Fixed Drawer Fronts	42	17 15/16	27 9/16	120.0	788.00
LPL4224L21	• 42" File, Retractable Doors	42	17 15/16	27 9/16	124.0	913.00

NOTE: Tennsco recommends the use of a counterweight (to counterbalance the weight of an open drawer) in all free-standing two-drawer files. To order a counterweight on any lateral file, add a "W" to the model number. Example: LPL3024L20W. Price listed on page 17.

THREE DRAWER LATERAL FILES



National Motor Freight Class: 150

CAT. NO.	DESCRIPTION	W	D	H	WT.	PRICE
LPL3036L30	30" File, Fixed Drawer Fronts	30	17 15/16	39 3/8	131.0	\$973.00
LPL3036L31	30" File, Retractable Doors	30	17 15/16	39 3/8	136.0	1,192.00
LPL3636L30	• 36" File, Fixed Drawer Fronts	36	17 15/16	39 3/8	145.0	966.00
LPL3636L31	• 36" File, Retractable Doors	36	17 15/16	39 3/8	151.0	1,136.00
LPL4236L30	• 42" File, Fixed Drawer Fronts	42	17 15/16	39 3/8	160.0	1,030.00
LPL4236L31	• 42" File, Retractable Doors	42	17 15/16	39 3/8	166.0	1,222.00

FOUR DRAWER LATERAL FILES



National Motor Freight Class: 150

CAT. NO.	DESCRIPTION	W	D	H	WT.	PRICE
LPL3048L40	30" File, Fixed Drawer Fronts	30	17 15/16	51 1/4	167.0	\$1,211.00
LPL3048L41	30" File, Retractable Doors	30	17 15/16	51 1/4	174.0	1,475.00
LPL3648L40	• 36" File, Fixed Drawer Fronts	36	17 15/16	51 1/4	184.0	1,185.00
LPL3648L41	• 36" File, Retractable Doors	36	17 15/16	51 1/4	192.0	1,418.00
LPL4248L40	• 42" File, Fixed Drawer Fronts	42	17 15/16	51 1/4	206.0	1,267.00
LPL4248L41	• 42" File, Retractable Doors	42	17 15/16	51 1/4	215.0	1,516.00

FIVE DRAWER LATERAL FILES



National Motor Freight Class: 150

CAT. NO.	DESCRIPTION	W	D	H	WT.	PRICE
LPL3060L50	30" File, Combination Unit*	30	17 15/16	65	205.0	\$1,547.00
LPL3060L51	30" File, Retractable Doors	30	17 15/16	65	213.0	1,799.00
LPL3660L50	• 36" File, Combination Unit*	36	17 15/16	65	227.0	1,479.00
LPL3660L51	• 36" File, Retractable Doors	36	17 15/16	65	239.0	1,739.00
LPL4260L50	• 42" File, Combination Unit*	42	17 15/16	65	262.0	1,581.00
LPL4260L51	• 42" File, Retractable Doors	42	17 15/16	65	270.0	1,850.00

*Top openings is a retractable roll-out drawer; four bottom openings are solid-front doors. For optional Posting Shelf, located 36" from the floor, add a "P" to the end of the model number and add \$85 to the list price. Example: L4260L50P.

Standard Colors



• Items with this symbol are available to ship in 2-3 days. Limited quantities and select colors.

•  (BLK)

Lateral Files, Overfiles & Accessories

Inside Drawer Dimensions	File	Width	Depth	Height	Locks
12" high drawer with retractable door	30"	27 ¹ / ₄ "	15 ⁷ / ₁₆ "	10 ⁷ / ₁₆ "	<ul style="list-style-type: none"> • One key unlocks all drawers at once. • Locks are core-removable. • Locks are keyed randomly. For keyed alike, add suffix "-KA" to model number. • Lateral Files, Vertical Files, and Card Files can be keyed alike if desired.
	36"	33 ¹ / ₄ "	15 ⁷ / ₁₆ "	10 ⁷ / ₁₆ "	
	42"	39 ¹ / ₄ "	15 ⁷ / ₁₆ "	10 ⁷ / ₁₆ "	
12" high drawer with fixed front	30"	27 ¹ / ₄ "	15 ⁷ / ₁₆ "	11 ¹ / ₈ "	
	36"	33 ¹ / ₄ "	15 ⁷ / ₁₆ "	11 ¹ / ₈ "	
	42"	39 ¹ / ₄ "	15 ⁷ / ₁₆ "	11 ¹ / ₈ "	

Installation guidelines
 Installation and safety instructions are located in top drawer of all lateral files.

Counterweights: To order a factory installed counterweight on any lateral file, add a "W" to the model number. Refer to "Counterweights" chart on p.17 for added cost.

SIX DRAWER LATERAL FILES



CAT. NO.	DESCRIPTION	W	D	H	WT.	PRICE
LPL3672L60	36" File, Combination Units*	36	17 15/16	76 7/8	227.0	\$1,756.00
LPL3672L61	36" File, Retractable Doors	36	17 15/16	76 7/8	286.0	1,936.00
LPL4272L60	42" File, Combination Units*	42	17 15/16	76 7/8	293.0	1,921.00
LPL4272L61	42" File, Retractable Doors	42	17 15/16	76 7/8	325.0	2,160.00

*Top two openings are retractable roll-out drawers; four bottom openings are solid-front doors.

National Motor Freight Class: 150

FILING SYSTEMS

OVERFILES



CAT. NO.	W	D	H	WT.	PRICE
Double Level					
L302OF	30	18	27 1/2	63.0	\$604.00
L362OF	36	18	27 1/2	76.0	653.00
L422OF	42	18	27 1/2	89.0	724.00

Can be attached to top of lateral files.

L362OF

National Motor Freight Class: 150

LAMINATE TOPS

CAT. NO.	W	D	H	WT.	PRICE
T1830*	30	18	1 1/16	17.0	\$171.00
T1836♥	36	18	1 1/16	23.0	203.00
T1842♥	42	18	1 1/16	26.0	266.00

*Top is only available in Mahogany.

When ordering laminate tops, specify Oak (L006), Mahogany (L005) or Titanium (TTM).



National Motor Freight Class: 70

COUNTERWEIGHTS

CAT. NO.	W	D	H	WT.	PRICE
For 2-Drawer Files					
T30CW-4	28 5/8	—	10 1/2	34.0	\$89.00
T36CW-4	34 5/8	—	10 1/2	41.0	105.00
T42CW-4	40 5/8	—	10 1/2	47.0	124.00
For 3, 4 and 5-Drawer Files					
T30CW-2	28 5/8	—	10 1/2	17.0	48.00
T36CW-2	34 5/8	—	10 1/2	20.0	57.00
T42CW-2	40 5/8	—	10 1/2	24.0	65.00

Used to counterbalance the weight of an open drawer. Attaches to bottom rear of cabinet. Recommended for use with all free standing two-drawer files.

May be pre-installed at factory.



Available in black only. National Motor Freight Class: 70

SHELF MODIFIERS (For Letter Depth Filing)

CAT. NO.	W	D	H	WT.	PRICE
AA200-30	30	2	3	1.0	\$18.70
AA200-36	36	2	3	1.0	19.80
AA200-42	42	2	3	2.0	21.00

Fits on bottom of drawer to help align letter filing folders. Prevents legal sized-filing.

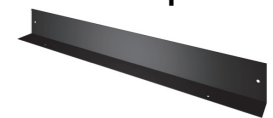

Available in black only. National Motor Freight Class: 70

CROSS RODS & DIVIDERS

CAT. NO.	W	D	H	WT.	PRICE
Cross Rods (pair)					
15CR●	15 3/4	1 7/8	7/8	1.0	\$9.30
Dividers					
5AD●	—	13 1/2	6 3/16	0.7	4.70

Cross rods are used in conjunction with hanging folder rods to file front-to-back. Dividers are used to separate file folders when hanging folder rods are not used.



Available in black only. National Motor Freight Class: 70

Standard Colors (Unless Otherwise Specified)



♥ ●
 Items with these symbols are available to ship in 2-3 days. Limited quantities and select colors.

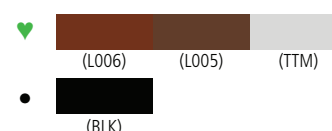

ADD-A-STACK UNITS



Stackable tier with 4 fixed dividers



Base & top with levelers

CAT. NO.	DESCRIPTION	INSIDE			OVERALL			WT.	PRICE
		W	D	H	W	D	H		
Letter Size Stackable Tiers									
AS36L	With 4 fixed dividers	35	13	9 7/8	36	13 3/16	10	20.0	\$102.00
AS48L	With 6 fixed dividers	47	13	9 7/8	48	13 3/16	10	23.0	133.00
Legal Size Stackable Tiers									
AS36G	With 4 fixed dividers	35	16	9 7/8	36	16 3/16	10	25.0	119.00
AS48G	With 6 fixed dividers	47	16	9 7/8	48	16 3/16	10	28.0	152.00
CAT. NO.	DESCRIPTION	BASE SIZE			TOP SIZE			WT.	PRICE
		W	D	H	W	D	H		
Letter Size Base & Top Sets									
AS36LBT	36" w, no levelers	36	13 3/16	1	36	13 3/16	1	18.0	\$105.00
AS36LBT-L	36" w, with levelers	36	13 3/16	4	36	13 3/16	1	22.0	150.00
AS48LBT	48" w, no levelers	48	13 3/16	1	48	13 3/16	1	23.0	132.00
AS48LBT-L	48" w, with levelers	48	13 3/16	4	48	13 3/16	1	29.0	176.00
Legal Size Base & Top Sets									
AS36GBT	36" w, no levelers	36	16 3/16	1	36	16 3/16	1	21.0	127.00
AS36GBT-L	36" w, with levelers	36	16 3/16	4	36	16 3/16	1	27.0	159.00
AS48GBT	48" w, no levelers	48	16 3/16	1	48	16 3/16	1	27.0	139.00
AS48GBT-L	48" w, with levelers	48	16 3/16	4	48	16 3/16	1	34.0	194.00

National Motor Freight Class: Stackable Tiers: 100; Base & Top Sets: 70

LITERATURE SORTERS



Tier With Four Literature Sorter Units



AS36GB
3-Divider Tier, Legal Size

CAT. NO.	DESCRIPTION	INSIDE			OVERALL			WT.	PRICE
		W	D	H	W	D	H		
Literature Sorters									
ASLT1	Letter Bin (Single Unit)	8 1/2	10 5/8	9 5/8	8 5/8	10 3/4	9 3/4	5.0	\$49.00
ASLT4	Letter Bin (Four Units)	8 1/2	10 5/8	9 5/8	36	10 3/4	9 3/4	29.0	184.00
Special 3-Divider Tier To Fit Literature Sorters									
AS36LB	With 3 Fixed Dividers	35	13	9 7/8	36	13 3/16	10	29.0	113.00
Literature Sorters									
ASLG1	Legal Bin (Single Unit)	8 1/2	13 5/8	9 5/8	8 5/8	13 3/4	9 3/4	6.0	54.00
ASLG4	Legal Bin (Four Units)	8 1/2	13 5/8	9 5/8	36	13 3/4	9 3/4	33.0	206.00
Special 3-Divider Tier To Fit Literature Sorters									
AS36GB	With 3 Fixed Dividers	35	16	9 7/8	36	16 3/16	10	35.0	124.00

Literature sorters require a special tier with three dividers (AS36LB) to allow room for sorter bins. Literature sorters are sold as single units (three trays) or a pack of four units (twelve trays).

National Motor Freight Class: 100

POSTING SHELF/DOOR, LOCKING DOOR



Posting Shelf



Locking Door

Fits letter or legal tiers.

National Motor Freight Class: 70

CAT. NO.	DESCRIPTION	W	D	H	WT.	PRICE
Posting Shelf/Door						
AS36PS	36" w Posting Shelf/Door	36	—	9 11/16	10.0	\$159.00
AS48PS	48" w Posting Shelf/Door	48	—	9 11/16	13.3	164.00
Locking Door*						
AS36LD	36" w Locking Door	36	—	9 11/16	7.0	188.00
AS48LD	48" w Locking Door	48	—	9 11/16	8.2	224.00

*Door with lock will not work as a posting shelf due to the lock mechanism.

Not to be used with end tab file folders.

Standard Colors



Sand (SND) Champagne/ Putty (CPY) Light Grey (LGY) Medium Grey (MGY) Black (BLK)

Literature Sorters, Fixed Shelf Lateral Files

LITERATURE SORTERS

CAT. NO.	W	D	H	WT.	PRICE
Letter Size					
4075♦	30 5/8	11 5/8	33	80.0	\$455.00
Extra Shelf (Pack of 5)					
4005♦	9	11	—	6.4	19.50
Legal Size					
5075♦	30 5/8	14 5/8	33	89.0	492.00
Extra Shelf (Pack of 5)					
5005♦	9	14	—	8.1	23.00

Comes standard with 18 shelves (to make 21 openings).
Shelves are adjustable on 1-1/2" centers. Same-depth units can be double-stacked.
National Motor Freight Class: 100



Letter Size (4075)



Legal Size (5075)

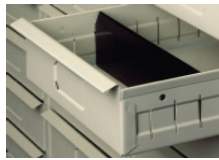

Drawer with
Optional Divider

CAT. NO.	W	D	H	WT.	PRICE
Letter Size					
2085♦	30 5/8	11 5/8	33	95.0	\$661.00
Legal Size					
3085♦	30 5/8	14 5/8	33	112.0	699.00
Optional Dividers (Pack of 30)*					
30AD●	9 1/16	—	2 11/32	6.7	57.00

*Dividers available in Black only.
Inside Drawer Dimensions (WxDxH): Letter Size: 9 x 11 1/4 x 2 3/4 Legal Size: 9 x 14 1/4 x 2 3/4

THIRTY DRAWER ORGANIZERS



Letter Size (2085)



Legal Size (3085)

Same-depth units can be double-stacked.
National Motor Freight Class: 100

FIXED SHELF LATERAL FILES

CAT. NO.	NO. OF OPENINGS	W	D	H	WT.	PRICE
Open Units						
FS350♦	5	36	17	63 1/2	124.0	\$818.00
FS360♦	6	36	17	75 1/4	150.0	891.00
FS370♦	7	36	17	87	175.0	1,000.00
Closed Units						
FS351L♦	5	36	17	63 1/2	180.0	1,436.00
FS361L♦	6	36	17	75 1/4	218.0	1,645.00
FS371L♦	7	36	17	87	242.0	1,821.00
Extra Divider						
FD-1108♦	—	—	11	8	0.8	2.90

Comes standard with four steel dividers per shelf level; dividers match cabinet color.
Equipped with shelf-modifier rod to accommodate both letter and legal filing.
All closed units have doors with long-pull handles and single lock secures all doors.

National Motor Freight Class: 100



Closed Unit



Open Unit

FIXED SHELF FILE

CAT. NO.	NO. OF OPENINGS	W	D	H	WT.	PRICE
Open Units						
FSF-78♦	7	34 1/2	13 1/2	78	117.0	\$622.00
Optional Posting Shelf						
FSFRS-1	—	30	12	1/2	8.6	60.00
Extra Divider						
PD-1108§	—	—	11	8	0.4	2.70

Comes standard with four plastic dividers per shelf level.

National Motor Freight Class: 85



Optional Posting Shelf



Standard Colors (Unless Otherwise Specified)



♦ ● §
Items with these symbols are available to ship in 2-3 days. Limited quantities and select colors.

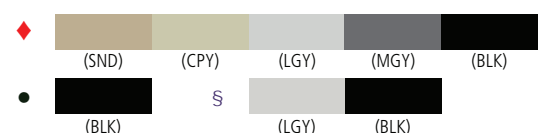

IMPERIAL SHELVING



Single Entry Unit,
88" Tall



Single Entry Unit,
76" Tall

Single entry units include 5 dividers and one backstop per level



Double Entry Unit,
88" Tall



Double Entry Unit,
76" Tall

Double entry units include 10 dividers and one center stop per level

Double entry units shipped in two cartons. All units have closed upright panels. Plastic feet included to protect carpet. No special tools required for assembly.

National Motor Freight Class: 70

CAT. NO.	NO. OF OPENINGS	W	D	H	WT.	PRICE
Single Entry Units						
Starter Units						
1276PC ■	6	36	12	76	117.0	\$425.00
127648PC ■	6	48	12	76	140.0	519.00
1576PC ■	6	36	15	76	125.0	457.00
1288PC ■	7	36	12	88	133.0	485.00
128848PC ■	7	48	12	88	156.0	584.00
1588PC ■	7	36	15	88	145.0	521.00
Adder Units						
1276AC ■	6	36	12	76	108.0	381.00
127648AC ■	6	48	12	76	130.0	459.00
1576AC ■	6	36	15	76	114.0	426.00
1288AC ■	7	36	12	88	125.0	452.00
128848AC ■	7	48	12	88	147.0	541.00
1588AC ■	7	36	15	88	132.0	481.00
Double Entry Units						
Starter Units						
2476PC ■	12	36	24	76	199.0	742.00
247648PC ■	12	48	24	76	247.0	897.00
3076PC ■	12	36	30	76	220.0	818.00
2488PC ■	14	36	24	88	229.0	832.00
248848PC ■	14	48	24	88	286.0	1,021.00
3088PC ■	14	36	30	88	256.0	904.00
Adder Units						
2476AC ■	12	36	24	76	177.0	683.00
247648AC ■	12	48	24	76	222.0	839.00
3076AC ■	12	36	30	76	205.0	797.00
2488AC ■	14	36	24	88	203.0	765.00
248848AC ■	14	48	24	88	257.0	957.00
3088AC ■	14	36	30	88	225.0	829.00
Reference Shelf						
RSMB-12 ■	—	30	12	5/8	9.3	62.00
RSMB-15 ■	—	30	15	5/8	9.7	64.00
RSMB-24 ■	—	30	24	5/8	10.8	79.00
RSMB-30 ■	—	30	30	5/8	11.6	71.00
Extra Shelf Kit						
ISK-3612 ■	—	36	12	—	13.0	46.00
ISK-3615 ■	—	36	15	—	14.1	50.00
ISK-4812 ■	—	48	12	—	18.8	59.00
ISK-3624 ■	—	36	24	—	24.0	77.00
ISK-3630 ■	—	36	30	—	25.0	84.00
ISK-4824 ■	—	48	24	—	30.0	98.00

National Motor Freight Class: 70

DOORS & BACKS FOR IMPERIAL SHELVING



Hinged Door
(adds 2 3/4" to outside depth of unit, including handles; frame uses 1/2" vertical filing space)

CAT. NO.	W	D	H	WT.	PRICE
Hinged Doors With Extended Frames					
LTHD-3676RHD	36	2 1/4	76	60.0	\$526.00
LTHD-4876RHD	48	2 1/4	76	86.0	727.00
LTHD-3688RHD	36	2 1/4	88	68.0	524.00
LTHD-4888RHD	48	2 1/4	88	89.0	757.00
Two Piece Back (to enclose units with doors)					
LTBP-3676-2	36	—	76	18.6	125.00
LTBP-4876-2	48	—	76	21.0	160.00
LTBP-3688-2	36	—	88	25.0	138.00
LTBP-4888-2	48	—	88	29.0	177.00

† All doors come standard with lock, in compliance with Health Insurance Portability and Accountability Act of 1996 (HIPAA) regulations.

National Motor Freight Class: 70

Standard Color



Sand
(SND)

Items with this symbol are available to ship in 2-3 days. Limited quantities and select colors.



(SND)

Regal, Capstone & Commercial Clip Shelving

REGAL SHELVING



CAT. NO.	NO. OF OPENINGS	W	D	H	SHELF CAPACITY	WT.	PRICE
Starter Units							
RGL-1236S	5	36	12	76	600	85.0	\$223.00
RGL-1536S	5	36	15	76	500	99.0	250.00
RGL-1836S	5	36	18	76	500	104.0	278.00
Adder Units							
RGL-1236A	5	36	12	76	600	80.0	196.00
RGL-1536A	5	36	15	76	500	94.0	220.00
RGL-1836A	5	36	18	76	500	100.0	250.00

Color: Sand only with Oak woodgrain particleboard shelf.
 Completely boltless assembly; only rubber mallet needed for assembly.
 Plastic feet included to protect carpets.
 National Motor Freight Class: 70

CAT. NO.	NO. OF OPENINGS	W	D	H	WT.	PRICE	CAT. NO.	SHELF CAPACITY	WT.	PRICE
Starter Units						Extra Shelves				
CS187636-MGY	4	36	18	76	105.0	\$346.00	CESL-3618-MGY	500	12.0	\$50.00
CS187642-MGY	4	42	18	76	114.0	374.00	CESL-4218-MGY	500	13.0	54.00
CS187648-MGY	4	48	18	76	122.0	433.00	CESL-4818-MGY	350	17.0	69.00
CS247636-MGY	4	36	24	76	123.0	391.00	CESL-3624-MGY	400	14.0	57.00
CS247642-MGY	4	42	24	76	134.0	423.00	CESL-4224-MGY	500	16.0	62.00
CS247648-MGY	4	48	24	76	144.0	488.00	CESL-4824-MGY	450	20.0	78.00
CS188836-MGY	5	36	18	88	110.0	389.00	CESL-3618-MGY	500	12.0	50.00
CS188842-MGY	5	42	18	88	119.0	417.00	CESL-4218-MGY	500	13.0	54.00
CS188848-MGY	5	48	18	88	127.0	484.00	CESL-4818-MGY	350	17.0	69.00
CS248836-MGY	5	36	24	88	130.0	391.00	CESL-3624-MGY	400	14.0	57.00
CS248842-MGY	5	42	24	88	141.0	473.00	CESL-4224-MGY	500	16.0	62.00
CS248848-MGY	5	48	24	88	151.0	549.00	CESL-4824-MGY	450	20.0	78.00
Adder Units						Extra Shelves				
CA187636-MGY	4	36	18	76	85.0	294.00	CESL-3618-MGY	500	12.0	\$50.00
CA187642-MGY	4	42	18	76	94.0	322.00	CESL-4218-MGY	500	13.0	54.00
CA187648-MGY	4	48	18	76	102.0	373.00	CESL-4818-MGY	350	17.0	69.00
CA247636-MGY	4	36	24	76	100.0	330.00	CESL-3624-MGY	400	14.0	57.00
CA247642-MGY	4	42	24	76	111.0	362.00	CESL-4224-MGY	500	16.0	62.00
CA247648-MGY	4	48	24	76	121.0	417.00	CESL-4824-MGY	450	20.0	78.00
CA188836-MGY	5	36	18	88	95.0	322.00	CESL-3618-MGY	500	12.0	50.00
CA188842-MGY	5	42	18	88	104.0	350.00	CESL-4218-MGY	500	13.0	54.00
CA188848-MGY	5	48	18	88	112.0	407.00	CESL-4818-MGY	350	17.0	69.00
CA248836-MGY	5	36	24	88	111.0	365.00	CESL-3624-MGY	400	14.0	57.00
CA248842-MGY	5	42	24	88	122.0	397.00	CESL-4224-MGY	500	16.0	62.00
CA248848-MGY	5	48	24	88	132.0	460.00	CESL-4824-MGY	450	20.0	78.00

CAPSTONE SHELVING



Color: Medium Grey only.
 National Motor Freight Class: 70

OFFICE SHELVING

CAT. NO.	NO. OF OPENINGS	W	D	H	SHELF CAPACITY	WT.	PRICE
Open-Style Shelving Units							
ESP-1236	4	36	12	75	250	48.0	\$182.00
ESP-1836	4	36	18	75	250	61.0	215.00
ESP-2436	4	36	24	75	250	73.0	258.00
ESP-6-1236	5	36	12	75	250	53.0	191.00
ESP-6-1836	5	36	18	75	250	68.0	228.00
ESP-6-2436	5	36	24	75	250	77.0	272.00
Closed-Style Shelving Units							
ESPC-1236	4	36	12	75	250	72.0	314.00
ESPC-1836	4	36	18	75	250	94.0	331.00
ESPC-2436	4	36	24	75	250	112.0	385.00
ESPC-6-1236	5	36	12	75	250	78.0	329.00
ESPC-6-1836	5	36	18	75	250	108.0	355.00
ESPC-6-2436	5	36	24	75	250	121.0	415.00
Extra Shelves*							
ES-12	-	36	12	1	250	6.0	23.00
ES-18	-	36	18	1	250	8.2	27.00
ES-24	-	36	24	1	250	10.8	33.00

*Shelves packaged as pairs; priced per shelf.

COMMERCIAL CLIP SHELVING PACKAGE



Open-Style



Closed-Style

Color: Medium Grey only.
 Individually cartoned.
 National Motor Freight classification: Class 70

Standard Colors (Unless Otherwise Specified)

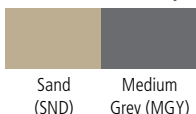

Items with these symbols are available to ship in 2-3 days. Limited quantities and select colors.

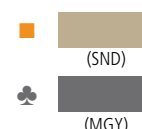

Single Tier Lockers

† Welded frames are riveted to welded locker body.

SINGLE TIER LOCKERS WITH LEGS



STS-121872-3



STS-121872-1

Other sizes available. Call factory for prices and delivery.

National Motor Freight Class:
Welded, 175;
Unassembled, 85

WELDED†			UNASSEMBLED			DIMENSIONS						
CATALOG NUMBER	UNIT WEIGHT	UNIT PRICE	CATALOG NUMBER	UNIT WEIGHT	UNIT PRICE	OPEN-INGS	OPENING			OVERALL UNIT		
							W	D	H	W	D	H
STS-121260-1	52	\$368.00	STK-121260-1	51	\$328.00	1	12	12	60	12	12	66
STS-121260-3	132	871.00	STK-121260-3	130	773.00	3	12	12	60	36	12	66
STS-121560-1	55	383.00	STK-121560-1	54	344.00	1	12	15	60	12	15	66
STS-121560-3	140	888.00	STK-121560-3	137	795.00	3	12	15	60	36	15	66
STS-121860-1	59	400.00	STK-121860-1	58	356.00	1	12	18	60	12	18	66
STS-121860-3	150	950.00	STK-121860-3	147	833.00	3	12	18	60	36	18	66
STS-151560-1	55	419.00	-	-	-	1	15	15	60	15	15	66
STS-151560-3	140	977.00	-	-	-	3	15	15	60	45	15	66
STS-151860-1	60	423.00	-	-	-	1	15	18	60	15	18	66
STS-151860-3	150	1,025.00	-	-	-	3	15	18	60	45	18	66
STS-121272-1	61	405.00	STK-121272-1	60	334.00	1	12	12	72	12	12	78
STS-121272-3	156	952.00	STK-121272-3	153	821.00	3	12	12	72	36	12	78
STS-121572-1▲	65	422.00	STK-121572-1	63	344.00	1	12	15	72	12	15	78
STS-121572-3▲	164	970.00	STK-121572-3	161	834.00	3	12	15	72	36	15	78
STS-121872-1▲	69	436.00	STK-121872-1♣	68	359.00	1	12	18	72	12	18	78
STS-121872-3▲	173	1,006.00	STK-121872-3♣	170	867.00	3	12	18	72	36	18	78
STS-151572-1▲	70	452.00	STK-151572-1	69	384.00	1	15	15	72	15	15	78
STS-151572-3▲	179	1,075.00	STK-151572-3	176	976.00	3	15	15	72	45	15	78
STS-151872-1▲	76	463.00	STK-151872-1♣	74	384.00	1	15	18	72	15	18	78
STS-151872-3▲	196	1,092.00	STK-151872-3♣	192	976.00	3	15	18	72	45	18	78
STS-152172-1	81	499.00	STK-152172-1	80	519.00	1	15	21	72	15	21	78
STS-152172-3	207	1,163.00	STK-152172-3	203	1,034.00	3	15	21	72	45	21	78
STS-181872-1♣	82	530.00	-	-	-	1	18	18	72	18	18	78
STS-182172-1♣	92	555.00	STK-182172-1	90	541.00	1	18	21	72	18	21	78
STS-182172-2	161	1,036.00	-	-	-	2	18	21	72	36	21	78
-	-	-	STK-182172-3	277	1,137.00	3	18	21	72	54	21	78
STS-242472-1♣	113	652.00	-	-	-	1	24	24	72	24	24	78

SINGLE TIER LOCKERS WITHOUT LEGS



STS-121872-C



STS-121872-A

Other sizes available. Call factory for prices and delivery.

National Motor Freight Class:
Welded, 175;
Unassembled, 85

WELDED†			UNASSEMBLED			DIMENSIONS						
CATALOG NUMBER	UNIT WEIGHT	UNIT PRICE	CATALOG NUMBER	UNIT WEIGHT	UNIT PRICE	OPEN-INGS	OPENING			OVERALL UNIT		
							W	D	H	W	D	H
STS-121260-A	50	\$359.00	STK-121260-A	49	\$333.00	1	12	12	60	12	12	60
STS-121260-C	127	855.00	STK-121260-C	125	761.00	3	12	12	60	36	12	60
STS-121560-A	53	370.00	STK-121560-A	52	341.00	1	12	15	60	12	15	60
STS-121560-C	135	849.00	STK-121560-C	133	793.00	3	12	15	60	36	15	60
STS-121860-A	57	416.00	STK-121860-A	56	355.00	1	12	18	60	12	18	60
STS-121860-C	145	925.00	STK-121860-C	142	824.00	3	12	18	60	36	18	60
STS-151560-A	53	397.00	STK-151560-A	52	348.00	1	15	15	60	15	15	60
STS-151560-C	135	944.00	-	-	-	3	15	15	60	45	15	60
STS-151860-A	55	412.00	STK-151860-A	54	372.00	1	15	18	60	15	18	60
STS-151860-C	145	997.00	STK-151860-C	142	892.00	3	15	18	60	45	18	60
STS-181860-A	69	511.00	-	-	-	1	18	18	60	18	18	60
STS-121272-A	59	384.00	STK-121272-A	58	330.00	1	12	12	72	12	12	72
STS-121272-C	147	927.00	STK-121272-C	145	809.00	3	12	12	72	36	12	72
STS-121572-A	64	404.00	STK-121572-A	62	341.00	1	12	15	72	12	15	72
STS-121572-C	159	940.00	STK-121572-C	156	823.00	3	12	15	72	36	15	72
STS-121872-A▲	68	417.00	STK-121872-A	66	351.00	1	12	18	72	12	18	72
STS-121872-C▲	169	970.00	STK-121872-C	166	856.00	3	12	18	72	36	18	72
STS-151572-A	73	441.00	-	-	-	1	15	15	72	15	15	72
STS-151572-C	182	1,047.00	-	-	-	3	15	15	72	45	15	72
STS-151872-A	76	447.00	STK-151872-A♣	75	380.00	1	15	18	72	15	18	72
STS-151872-C	191	1,071.00	STK-151872-C♣	187	966.00	3	15	18	72	45	18	72
STS-152172-A	81	509.00	STK-152172-A	80	502.00	1	15	21	72	15	21	72
STS-152172-C	202	1,139.00	STK-152172-C	199	1,024.00	3	15	21	72	45	21	72
STS-182172-A	86	541.00	STK-182172-A	84	531.00	1	18	21	72	18	21	72
STS-182172-B	151	982.00	-	-	-	2	18	21	72	36	21	72
-	-	-	STK-182172-C	272	1,128.00	3	18	21	72	54	21	72
STS-242472-A♣	107	613.00	-	-	-	1	24	24	72	24	24	72

Standard Colors



▲ ♣
Items with these symbols are available to ship in 2-3 days. Limited quantities and select colors.

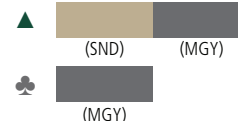

Double Tier Lockers

† Welded frames are riveted to welded locker body.

DOUBLE TIER LOCKERS WITH LEGS



DTS-121836-3



DTS-121836-1

Other sizes available. Call factory for prices and delivery.

National Motor Freight Class:
Welded, 175;
Unassembled, 85

WELDED†			UNASSEMBLED			DIMENSIONS						
CATALOG NUMBER	UNIT WEIGHT	UNIT PRICE	CATALOG NUMBER	UNIT WEIGHT	UNIT PRICE	OPEN-INGS	OPENING			OVERALL UNIT		
							W	D	H	W	D	H
DTS-121230-1	54	\$402.00	DTK-121230-1	53	\$351.00	2	12	12	30	12	12	66
DTS-121230-3	134	989.00	DTK-121230-3	132	849.00	6	12	12	30	36	12	66
DTS-121530-1	59	414.00	DTK-121530-1	58	361.00	2	12	15	30	12	15	66
DTS-121530-3	148	1,012.00	DTK-121530-3	145	860.00	6	12	15	30	36	15	66
DTS-121830-1	64	423.00	DTK-121830-1	63	370.00	2	12	18	30	12	18	66
DTS-121830-3	160	1,038.00	DTK-121830-3	157	922.00	6	12	18	30	36	18	66
DTS-151530-1	64	450.00	DTK-151530-1	63	393.00	2	15	15	30	15	15	66
DTS-151530-3	160	1,130.00	DTK-151530-3	157	1,007.00	6	15	15	30	45	15	66
DTS-151830-1	69	465.00	DTK-151830-1	68	403.00	2	15	18	30	15	18	66
DTS-151830-3	173	1,160.00	DTK-151830-3	169	1,024.00	6	15	18	30	45	18	66
DTS-121236-1▲	63	431.00	DTK-121236-1♣	61	364.00	2	12	12	36	12	12	78
DTS-121236-3▲	156	1,009.00	DTK-121236-3♣	153	919.00	6	12	12	36	36	12	78
DTS-121536-1▲	66	444.00	DTK-121536-1♣	65	374.00	2	12	15	36	12	15	78
DTS-121536-3▲	164	1,032.00	DTK-121536-3♣	161	921.00	6	12	15	36	36	15	78
DTS-121836-1▲	70	453.00	DTK-121836-1♣	69	387.00	2	12	18	36	12	18	78
DTS-121836-3▲	175	1,053.00	DTK-121836-3♣	172	952.00	6	12	18	36	36	18	78
DTS-151536-1	75	480.00	DTK-151536-1	74	402.00	2	15	15	36	15	15	78
DTS-151536-3	187	1,173.00	DTK-151536-3	184	1,043.00	6	15	15	36	45	15	78
DTS-151836-1▲	77	494.00	DTK-151836-1	75	413.00	2	15	18	36	15	18	78
DTS-151836-3▲	196	1,206.00	DTK-151836-3	193	1,033.00	6	15	18	36	45	18	78

DOUBLE TIER LOCKERS WITHOUT LEGS

WELDED†			UNASSEMBLED			DIMENSIONS						
CATALOG NUMBER	UNIT WEIGHT	UNIT PRICE	CATALOG NUMBER	UNIT WEIGHT	UNIT PRICE	OPEN-INGS	OPENING			OVERALL UNIT		
							W	D	H	W	D	H
DTS-121230-A	48	\$387.00	DTK-121230-A	47	\$345.00	2	12	12	30	12	12	60
DTS-121230-C	120	931.00	DTK-121230-C	118	843.00	6	12	12	30	36	12	60
DTS-121530-A	52	400.00	DTK-121530-A	51	356.00	2	12	15	30	12	15	60
DTS-121530-C	130	972.00	DTK-121530-C	128	853.00	6	12	15	30	36	15	60
DTS-121830-A	57	408.00	DTK-121830-A	56	369.00	2	12	18	30	12	18	60
DTS-121830-C	145	1,018.00	DTK-121830-C	142	914.00	6	12	18	30	36	18	60
DTS-151530-A	62	443.00	-	-	-	2	15	15	30	15	15	60
DTS-151530-C	155	1,101.00	DTK-151530-C	152	998.00	6	15	15	30	45	15	60
DTS-151830-A	67	452.00	DTK-151830-A	66	402.00	2	15	18	30	15	18	60
DTS-151830-C	167	1,137.00	DTK-151830-C	164	966.00	6	15	18	30	45	18	60
DTS-121236-A	60	414.00	DTK-121236-A	59	359.00	2	12	12	36	12	12	72
DTS-121236-C▲	153	1,008.00	DTK-121236-C	150	898.00	6	12	12	36	36	12	72
DTS-121536-A	63	427.00	DTK-121536-A	62	372.00	2	12	15	36	12	15	72
DTS-121536-C▲	160	1,015.00	DTK-121536-C	158	912.00	6	12	15	36	36	15	72
DTS-121836-A▲	68	433.00	DTK-121836-A	66	385.00	2	12	18	36	12	18	72
DTS-121836-C▲	171	1,018.00	DTK-121836-C	168	943.00	6	12	18	36	36	18	72
DTS-151536-A	73	462.00	DTK-151536-A	72	398.00	2	15	15	36	15	15	72
DTS-151536-C	183	1,146.00	DTK-151536-C	180	977.00	6	15	15	36	45	15	72
DTS-151836-A	77	486.00	DTK-151836-A	76	409.00	2	15	18	36	15	18	72
DTS-151836-C	193	1,170.00	DTK-151836-C	189	1,037.00	6	15	18	36	45	18	72



DTS-121836-C



DTS-121836-A

Other sizes available. Call factory for prices and delivery.

National Motor Freight Class:
Welded, 175;
Unassembled, 85

Standard Colors



▲ ♣
Items with these symbols are available to ship in 2-3 days. Limited quantities and select colors.

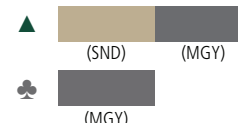

Triple Tier Lockers

† Welded frames are riveted to welded locker body.

TRIPLE TIER LOCKERS WITH LEGS



TTS-121824-3



TTS-121824-1

WELDED†			UNASSEMBLED			DIMENSIONS						
CATALOG NUMBER	UNIT WEIGHT	UNIT PRICE	CATALOG NUMBER	UNIT WEIGHT	UNIT PRICE	OPENINGS	OPENING			OVERALL UNIT		
							W	D	H	W	D	H
TTS-121224-1	61	\$487.00	TTK-121224-1	60	\$435.00	3	12	12	24	12	12	78
TTS-121224-3	153	1,219.00	TTK-121224-3	150	1,101.00	9	12	12	24	36	12	78
TTS-121524-1	68	501.00	TTK-121524-1	67	444.00	3	12	15	24	12	15	78
TTS-121524-3	173	1,265.00	TTK-121524-3	170	1,118.00	9	12	15	24	36	15	78
TTS-121824-1	72	509.00	TTK-121824-1	71	459.00	3	12	18	24	12	18	78
TTS-121824-3	184	1,295.00	TTK-121824-3	180	1,150.00	9	12	18	24	36	18	78
TTS-151524-1	66	537.00	TTK-151524-1	65	471.00	3	15	15	24	15	15	78
TTS-151524-3	165	1,389.00	TTK-151524-3	162	1,200.00	9	15	15	24	45	15	78
TTS-151824-1	71	550.00	TTK-151824-1	70	485.00	3	15	18	24	15	18	78
TTS-151824-3	178	1,420.00	TTK-151824-3	174	1,233.00	9	15	18	24	45	18	78

Other sizes available. Call factory for prices and delivery.

National Motor Freight Class:

Welded, 175;

Unassembled, 85

TRIPLE TIER LOCKERS WITHOUT LEGS



TTS-121824-C



TTS-121824-A

WELDED†			UNASSEMBLED			DIMENSIONS						
CATALOG NUMBER	UNIT WEIGHT	UNIT PRICE	CATALOG NUMBER	UNIT WEIGHT	UNIT PRICE	OPENINGS	OPENING			OVERALL UNIT		
							W	D	H	W	D	H
TTS-121224-A	63	\$472.00	TTK-121224-A	62	\$430.00	3	12	12	24	12	12	72
TTS-121224-C	159	1,212.00	TTK-121224-C	156	1,090.00	9	12	12	24	36	12	72
TTS-121524-A	66	486.00	TTK-121524-A	65	441.00	3	12	15	24	12	15	72
TTS-121524-C	166	1,239.00	TTK-121524-C	163	1,122.00	9	12	15	24	36	15	72
TTS-121824-A	71	502.00	TTK-121824-A	70	455.00	3	12	18	24	12	18	72
TTS-121824-C	179	1,265.00	TTK-121824-C	175	1,139.00	9	12	18	24	36	18	72
TTS-151524-A	67	525.00	TTK-151524-A	66	469.00	3	15	15	24	15	15	72
TTS-151524-C	168	1,358.00	TTK-151524-C	164	1,189.00	9	15	15	24	45	15	72
TTS-151824-A	72	546.00	TTK-151824-A	71	481.00	3	15	18	24	15	18	72
TTS-151824-C	180	1,386.00	TTK-151824-C	177	1,222.00	9	15	18	24	45	18	72

Other sizes available. Call factory for prices and delivery.

National Motor Freight Class:

Welded, 175;

Unassembled, 85

Standard Colors



Sand (SND) Champagne/ Putty (CPY) Light Grey (LGY) Medium Grey (MGY) Black (BLK)

Box Lockers

† Welded frames are riveted to welded locker body.

5-TIER BOX LOCKERS WITH LEGS

WELDED†			UNASSEMBLED			DIMENSIONS						
CATALOG NUMBER	UNIT WEIGHT	UNIT PRICE	CATALOG NUMBER	UNIT WEIGHT	UNIT PRICE	OPEN-INGS	OPENING			OVERALL UNIT		
							W	D	H	W	D	H
BS5-121212-1	52	\$396.00	BK5-121212-1	51	\$325.00	5	12	12	12	12	12	66
BS5-121212-3	131	820.00	BK5-121212-3	129	777.00	15	12	12	12	36	12	66
BS5-121512-1▲	56	416.00	BK5-121512-1	55	339.00	5	12	15	12	12	15	66
BS5-121512-3▲	141	916.00	BK5-121512-3	138	804.00	15	12	15	12	36	15	66
BS5-121812-1	61	432.00	BK5-121812-1	60	352.00	5	12	18	12	12	18	66
BS5-121812-3	152	959.00	BK5-121812-3	149	829.00	15	12	18	12	36	18	66
BS5-151512-1	64	473.00	BK5-151512-1	63	383.00	5	15	15	12	15	15	66
BS5-151512-3	161	1,070.00	BK5-151512-3	159	936.00	15	15	15	12	45	15	66
BS5-151812-1	67	486.00	BK5-151812-1	65	395.00	5	15	18	12	15	18	66
BS5-151812-3	167	1,127.00	BK5-151812-3	164	967.00	15	15	18	12	45	18	66



National Motor Freight Class: Welded, 175; Unassembled, 85. Other sizes available. Call factory for pricing.

5-TIER BOX LOCKERS WITHOUT LEGS

WELDED†			UNASSEMBLED			DIMENSIONS						
CATALOG NUMBER	UNIT WEIGHT	UNIT PRICE	CATALOG NUMBER	UNIT WEIGHT	UNIT PRICE	OPEN-INGS	OPENING			OVERALL UNIT		
							W	D	H	W	D	H
BS5-121212-A	50	\$389.00	BK5-121212-A	49	\$321.00	5	12	12	12	12	12	60
BS5-121212-C	126	835.00	BK5-121212-C	124	773.00	15	12	12	12	36	12	60
BS5-121512-A	54	405.00	BK5-121512-A	53	334.00	5	12	15	12	12	15	60
BS5-121512-C	136	856.00	BK5-121512-C	134	794.00	15	12	15	12	36	15	60
BS5-121812-A	59	410.00	BK5-121812-A	58	348.00	5	12	18	12	12	18	60
BS5-121812-C	147	916.00	BK5-121812-C	144	816.00	15	12	18	12	36	18	60
BS5-151512-A	62	494.00	BK5-151512-A	61	378.00	5	15	15	12	15	15	60
BS5-151512-C	156	1,055.00	BK5-151512-C	154	926.00	15	15	15	12	45	15	60
BS5-151812-A	65	480.00	BK5-151812-A	63	391.00	5	15	18	12	15	18	60
BS5-151812-C	162	1,094.00	BK5-151812-C	159	954.00	15	15	18	12	45	18	60



National Motor Freight Class: Welded, 175; Unassembled, 85. Other sizes available. Call factory for pricing.

6-TIER BOX LOCKERS WITH LEGS

WELDED†			UNASSEMBLED			DIMENSIONS						
CATALOG NUMBER	UNIT WEIGHT	UNIT PRICE	CATALOG NUMBER	UNIT WEIGHT	UNIT PRICE	OPEN-INGS	OPENING			OVERALL UNIT		
							W	D	H	W	D	H
BS6-121212-1▲	61	\$436.00	BK6-121212-1♣	60	\$353.00	6	12	12	12	12	12	78
BS6-121212-3▲	154	1,017.00	BK6-121212-3♣	151	879.00	18	12	12	12	36	12	78
BS6-121512-1▲	66	455.00	BK6-121512-1♣	65	367.00	6	12	15	12	12	15	78
BS6-121512-3▲	167	1,107.00	BK6-121512-3♣	164	910.00	18	12	15	12	36	15	78
BS6-121812-1▲	71	484.00	BK6-121812-1♣	70	386.00	6	12	18	12	12	18	78
BS6-121812-3▲	180	1,167.00	BK6-121812-3♣	177	939.00	18	12	18	12	36	18	78
BS6-151512-1	76	520.00	BK6-151512-1	75	421.00	6	15	15	12	15	15	78
BS6-151512-3	190	1,308.00	BK6-151512-3	187	1,067.00	18	15	15	12	45	15	78
BS6-151812-1♣	79	535.00	BK6-151812-1	78	431.00	6	15	18	12	15	18	78
BS6-151812-3♣	198	1,340.00	BK6-151812-3	194	1,101.00	18	15	18	12	45	18	78



National Motor Freight Class: Welded, 175; Unassembled, 85. Other sizes available. Call factory for pricing.

6-TIER BOX LOCKERS WITHOUT LEGS

WELDED†			UNASSEMBLED			DIMENSIONS						
CATALOG NUMBER	UNIT WEIGHT	UNIT PRICE	CATALOG NUMBER	UNIT WEIGHT	UNIT PRICE	OPEN-INGS	OPENING			OVERALL UNIT		
							W	D	H	W	D	H
BS6-121212-A♣	59	\$425.00	BK6-121212-A	58	\$347.00	6	12	12	12	12	12	72
BS6-121212-C♣	149	1,039.00	BK6-121212-C	146	868.00	18	12	12	12	36	12	72
BS6-121512-A	64	444.00	BK6-121512-A	63	362.00	6	12	15	12	12	15	72
BS6-121512-C	161	1,073.00	BK6-121512-C	158	895.00	18	12	15	12	36	15	72
BS6-121812-A▲	69	461.00	BK6-121812-A	67	380.00	6	12	18	12	12	18	72
BS6-121812-C▲	175	1,148.00	BK6-121812-C	172	925.00	18	12	18	12	36	18	72
BS6-151512-A	74	520.00	BK6-151512-A	73	416.00	6	15	15	12	15	15	72
BS6-151512-C	185	1,279.00	BK6-151512-C	182	1,054.00	18	15	15	12	45	15	72
BS6-151812-A	79	534.00	BK6-151812-A	78	427.00	6	15	18	12	15	18	72
BS6-151812-C	198	1,315.00	BK6-151812-C	194	1,088.00	18	15	18	12	45	18	72



National Motor Freight Class: Welded, 175; Unassembled, 85. Other sizes available. Call factory for pricing.

Standard Colors



▲ ♣ Items with these symbols are available to ship in 2-3 days. Limited quantities and select colors.

▲ (SND) (MGY)
♣ (MGY)

LOCKERS

Heavy-Duty Lockers

† Welded frames are riveted to welded locker body.

WELDED† HEAVY-DUTY SINGLE TIER LOCKERS



HSL-121872-C



HSL-121872-1

Locker body and shelf constructed of 16 gauge steel. Shipped assembled.
National Motor Freight Class: 175

CATALOG NUMBER	NO. OF COMPARTMENTS	OPENING			OVERALL UNIT			WEIGHT	PRICE
		W	D	H	W	D	H		
WITH LEGS									
HSL-121872-1	1	12	18	72	12	18	78	109	\$554.00
HSL-121872-3	3	12	18	72	36	18	78	280	1,183.00
HSL-151872-1	1	15	18	72	15	18	78	120	583.00
HSL-151872-3	3	15	18	72	45	18	78	313	1,314.00
HSL-181872-1	1	18	18	72	18	18	78	144	616.00
HSL-181872-2	2	18	18	72	36	18	78	263	1,111.00
WITHOUT LEGS									
HSL-121872-A	1	12	18	72	12	18	72	107	547.00
HSL-121872-C	3	12	18	72	36	18	72	277	1,162.00
HSL-151872-A	1	15	18	72	15	18	72	119	606.00
HSL-151872-C	3	15	18	72	45	18	72	311	1,301.00
HSL-181872-A	1	18	18	72	18	18	72	142	634.00
HSL-181872-B	2	18	18	72	36	18	72	260	1,080.00

WELDED† HEAVY-DUTY DOUBLE TIER LOCKERS



HDL-121836-3



HDL-121836-A

Locker body and shelf constructed of 16 gauge steel. Shipped assembled.
National Motor Freight Class: 175

CATALOG NUMBER	NO. OF COMPARTMENTS	OPENING			OVERALL UNIT			WEIGHT	PRICE
		W	D	H	W	D	H		
WITH LEGS									
HDL-121836-1	2	12	18	36	12	18	78	111	\$586.00
HDL-121836-3	6	12	18	36	36	18	78	285	1,292.00
HDL-151836-1	2	15	18	36	15	18	78	135	614.00
HDL-151836-3	6	15	18	36	45	18	78	331	1,491.00
WITHOUT LEGS									
HDL-121836-A	2	12	18	36	12	18	72	109	575.00
HDL-121836-C	6	12	18	36	36	18	72	282	1,279.00
HDL-151836-A	2	15	18	36	15	18	72	133	673.00
HDL-151836-C	6	15	18	36	45	18	72	327	1,426.00

WELDED† HEAVY-DUTY 6-TIER BOX LOCKERS



HBL6-1218-C



HBL6-1218-A

Locker body and shelf constructed of 16 gauge steel. Shipped assembled.
National Motor Freight Class: 175

CATALOG NUMBER	NO. OF COMPARTMENTS	OPENING			OVERALL UNIT			WEIGHT	PRICE
		W	D	H	W	D	H		
WITH LEGS									
HBL6-1218-1	6	12	18	12	12	18	78	126	\$717.00
HBL6-1218-3	18	12	18	12	36	18	78	332	1,651.00
WITHOUT LEGS									
HBL6-1218-A	6	12	18	12	12	18	72	124	705.00
HBL6-1218-C	18	12	18	12	36	18	72	328	1,621.00

Standard Colors



Sand (SND) Champagne/ Putty (CPY) Light Grey (LGY) Medium Grey (MGY) Black (BLK)

Specialty Lockers

†Welded frames are riveted to welded locker body.

WELDED† COMBINATION LOCKERS

CATALOG NUMBER	NO. OF COMPARTMENTS	OPENING			OVERALL UNIT			WEIGHT	PRICE
		W	D	H	W	D	H		
WITH LEGS									
CMS-182172-1	7	18	21	72	18	21	78	121	\$716.00
CMS-242172-1♣	7	24	21	72	24	21	78	126	\$821.00
WITHOUT LEGS									
CMS-182172-A	7	18	21	72	18	21	72	119	\$699.00
CMS-242172-A♣	7	24	21	72	24	21	72	124	\$799.00

Shipped assembled.
National Motor Freight Class: 175



CMS-242172-A

WELDED† HALF-HEIGHT LOCKERS

CATALOG NUMBER	NO. OF COMPARTMENTS	OPENING			OVERALL UNIT			WEIGHT	PRICE
		W	D	H	W	D	H		
WITH LEGS									
STS-121236-1	1	12	12	36	12	12	42	37	\$305.00
STS-121836-1	1	12	18	36	12	18	42	42	\$344.00
WITHOUT LEGS									
STS-121236-A	1	12	12	36	12	12	36	35	\$293.00
STS-121836-A	1	12	18	36	12	18	36	40	\$327.00

Shipped assembled.
National Motor Freight Class: 175



STS-121836-A

WELDED† WALL MOUNTED LOCKERS

CATALOG NUMBER	NO. OF COMPARTMENTS	OPENING			OVERALL UNIT			WEIGHT	PRICE
		W	D	H	W	D	H		
3-PERSON LOCKER									
BS1-121812-3*♣	3	12	18	12	36	18	12	43	\$434.00
4-PERSON LOCKER									
BS1-121812-4*♣	4	12	18	12	48	18	12	55	\$473.00

*Wall mounted lockers are shipped assembled only. Coat rods are installed in field.
Coat rod and brackets included with all 3-person and 4-person lockers.
National Motor Freight Class: 175



BS1-121812-3



BS1-121812-4

WELDED† WALL MOUNTED C-THRU LOCKERS

CATALOG NUMBER	NO. OF COMPARTMENTS	OPENING			OVERALL UNIT			WEIGHT	PRICE
		W	D	H	W	D	H		
4-PERSON LOCKER									
CBS1-121812-4*	4	12	18	12	48	18	12	53	\$535.00

*Shipped assembled. Coat rod and brackets included. Coat rods are installed in field.
National Motor Freight Class: 175



CBS1-121812-4

Standard Colors



♣ Items with this symbol are available to ship in 2-3 days. Limited quantities and select colors. ♣ (MGY)

LOCKERS

15 & 16 Person Lockers

† Welded frames are riveted to welded locker body.

15 PERSON LOCKERS



SRS-601878-1

CATALOG NUMBER	NO. OF COMPARTMENTS	OPENING			OVERALL UNIT			WEIGHT	PRICE
		W	D	H	W	D	H		
WELDED† WITH LEGS									
SRS-601878-1*	15	12	18	12	60	18	78	182	\$1,308.00
UNASSEMBLED WITH LEGS									
SRK-601878-1	15	12	18	12	60	18	78	179	1,016.00
WELDED† WITHOUT LEGS									
SRS-601872-A*	15	12	18	12	60	18	72	180	1,294.00
UNASSEMBLED WITHOUT LEGS									
SRK-601872-A	15	12	18	12	60	18	72	177	1,005.00

*Shipped assembled. Coat rod and brackets included. Center section and coat rods are installed in field.
National Motor Freight Class: Assembled, 175; Unassembled, 85

16 PERSON LOCKERS



SRS-721878-1

CATALOG NUMBER	NO. OF COMPARTMENTS	OPENING			OVERALL UNIT			WEIGHT	PRICE
		W	D	H	W	D	H		
WELDED† WITH LEGS									
SRS-721878-1*♣	16	12	18	12	72	18	78	190	\$1,365.00
UNASSEMBLED WITH LEGS									
SRK-721878-1♣	16	12	18	12	72	18	78	187	1,070.00
WELDED† WITHOUT LEGS									
SRS-721872-A*♣	16	12	18	12	72	18	72	184	1,349.00
UNASSEMBLED WITHOUT LEGS									
SRK-721872-A	16	12	18	12	72	18	72	181	1,076.00

*Shipped assembled. Coat rod and brackets included. Center section and coat rods are installed in field.
National Motor Freight Class: Assembled, 175; Unassembled, 85

16 PERSON LOCKER WITH C-THRU DOORS



CSRS-721872-A

CATALOG NUMBER	NO. OF COMPARTMENTS	OPENING			OVERALL UNIT			WEIGHT	PRICE
		W	D	H	W	D	H		
ASSEMBLED WITH LEGS									
CSRS-721878-1*	16	12	18	12	72	18	78	180	\$1,498.00
ASSEMBLED WITHOUT LEGS									
CSRS-721872-A*	16	12	18	12	72	18	72	175	1,486.00

*Shipped assembled. Coat rod and brackets included. Center section and coat rods are installed in field.
National Motor Freight Class: Assembled, 175

Standard Colors



Items with this symbol are available to ship in 2-3 days. Limited quantities and select colors.



(MGY)

C-Thru Lockers

† Welded frames are riveted to welded locker body.

WELDED† SINGLE TIER C-THRU LOCKERS

CATALOG NUMBER	NO. OF COMPARTMENTS	OPENING			OVERALL UNIT			WEIGHT	PRICE
		W	D	H	W	D	H		
WITH LEGS									
CSL-121272-1	1	12	12	72	12	12	78	61	\$534.00
CSL-121272-3	3	12	12	72	36	12	78	156	1,316.00
CSL-121572-1	1	12	15	72	12	15	78	65	548.00
CSL-121572-3	3	12	15	72	36	15	78	164	1,343.00
CSL-121872-1	1	12	18	72	12	18	78	69	565.00
CSL-121872-3	3	12	18	72	36	18	78	173	1,380.00
CSL-151872-1	1	15	18	72	15	18	78	76	604.00
CSL-151872-3	3	15	18	72	45	18	78	196	1,502.00
WITHOUT LEGS									
CSL-121572-C	3	12	15	72	36	15	72	159	1,322.00
CSL-121872-A	1	12	18	72	12	18	72	67	565.00
CSL-121872-C	3	12	18	72	36	18	72	168	1,361.00
CSL-151872-A	1	15	18	72	15	18	72	74	581.00
CSL-151872-C	3	15	18	72	45	18	72	191	1,456.00



CSL-121872-3



CSL-121872-1

Shipped assembled.
National Motor Freight Class: 175

WELDED† DOUBLE TIER C-THRU LOCKERS

CATALOG NUMBER	NO. OF COMPARTMENTS	OPENING			OVERALL UNIT			WEIGHT	PRICE
		W	D	H	W	D	H		
WITH LEGS									
CDL-121236-1	2	12	12	36	12	12	78	59	\$570.00
CDL-121236-3	6	12	12	36	36	12	78	151	1,576.00
CDL-121536-1	2	12	15	36	12	15	78	63	633.00
CDL-121536-3	6	12	15	36	36	15	78	159	1,601.00
CDL-121836-1	2	12	18	36	12	18	78	67	642.00
CDL-121836-3	6	12	18	36	36	18	78	168	1,618.00
CDL-151836-1	2	15	18	36	15	18	78	74	645.00
CDL-151836-3	6	15	18	36	45	18	78	191	1,732.00
WITHOUT LEGS									
CDL-121236-A	2	12	12	36	12	12	72	57	626.00
CDL-121236-C	6	12	12	36	36	12	72	146	1,582.00
CDL-121536-C	6	12	15	36	36	15	72	154	1,470.00
CDL-121836-A	2	12	18	36	12	18	72	65	627.00
CDL-121836-C	6	12	18	36	36	18	72	163	1,592.00
CDL-151836-C	6	15	18	36	45	18	72	186	1,717.00



CDL-121836-3



CDL-121836-1

Shipped assembled.
National Motor Freight Class: 175

WELDED† 6-TIER C-THRU BOX LOCKERS

CATALOG NUMBER	NO. OF COMPARTMENTS	OPENING			OVERALL UNIT			WEIGHT	PRICE
		W	D	H	W	D	H		
WITH LEGS									
CBL6-121212-1♣	6	12	12	12	12	12	78	53	\$477.00
CBL6-121212-3♣	18	12	12	12	36	12	78	131	1,279.00
CBL6-121512-1	6	12	15	12	12	15	78	58	499.00
CBL6-121512-3	18	12	15	12	36	15	78	145	1,282.00
CBL6-121812-1	6	12	18	12	12	18	78	63	514.00
CBL6-121812-3	18	12	18	12	36	18	78	157	1,321.00
WITHOUT LEGS									
CBL6-121212-A	6	12	12	12	12	12	72	51	469.00
CBL6-121212-C	18	12	12	12	36	12	72	126	1,216.00
CBL6-121512-A	6	12	15	12	12	15	72	56	492.00
CBL6-121512-C	18	12	15	12	36	15	72	140	1,265.00
CBL6-121812-A	6	12	18	12	12	18	72	61	506.00
CBL6-121812-C	18	12	18	12	36	18	72	152	1,294.00



CBL6-121812-3



CBL6-121812-A

Shipped assembled.
National Motor Freight Class: 175

Standard Colors



♣ Items with this symbol are available to ship in 2-3 days. Limited quantities and select colors.



LOCKERS

Heavy-Duty Ventilated Lockers

† Welded frames are riveted to welded locker body.

WELDED VENTILATED SINGLE TIER LOCKERS



VSL-121872-1

VSL-121872-3

CATALOG NUMBER	NO. OF COMPARTMENTS	OPENING			OVERALL UNIT			WEIGHT	PRICE
		W	D	H	W	D	H		
WITH LEGS									
VSL-121872-1♣	1	12	18	72	12	18	78	88	\$578.00
VSL-121872-3♣	3	12	18	72	36	18	78	219	1,334.00
VSL-151872-1	1	15	18	72	15	18	78	93	630.00
VSL-151872-3	3	15	18	72	45	18	78	233	1,516.00
VSL-181872-1	1	18	18	72	18	18	78	98	694.00
VSL-181872-2	2	18	18	72	36	18	78	245	1,272.00
WITHOUT LEGS									
VSL-121872-A	1	12	18	72	12	18	72	86	582.00
VSL-121872-C	3	12	18	72	36	18	72	214	1,313.00
VSL-151872-A	1	15	18	72	15	18	72	91	617.00
VSL-151872-C	3	15	18	72	45	18	72	228	1,486.00
VSL-181872-A	1	18	18	72	18	18	72	96	686.00
VSL-181872-B	2	18	18	72	36	18	72	241	1,263.00

Shipped assembled.
National Motor Freight Class: 175

WELDED VENTILATED DOUBLE TIER LOCKERS



VDL-121836-1

VDL-121836-3

CATALOG NUMBER	NO. OF COMPARTMENTS	OPENING			OVERALL UNIT			WEIGHT	PRICE
		W	D	H	W	D	H		
WITH LEGS									
VDL-121836-1♣	2	12	18	36	12	18	78	88	\$617.00
VDL-121836-3♣	6	12	18	36	36	18	78	223	1,459.00
VDL-151836-1	2	15	18	36	15	18	78	93	693.00
VDL-151836-3	6	15	18	36	45	18	78	233	1,676.00
WITHOUT LEGS									
VDL-121836-A	2	12	18	36	12	18	72	84	623.00
VDL-121836-C	6	12	18	36	36	18	72	209	1,436.00
VDL-151836-A	2	15	18	36	15	18	72	89	664.00
VDL-151836-C	6	15	18	36	45	18	72	223	1,657.00

Shipped assembled.
National Motor Freight Class: 175

WELDED VENTILATED 6-TIER BOX LOCKERS

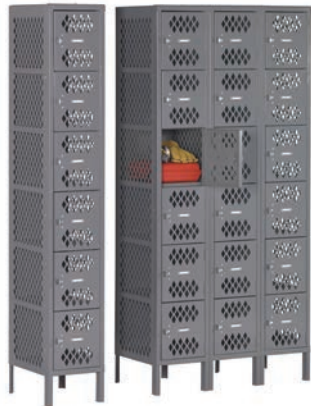

VBL6-1218-1

VBL6-1218-3

CATALOG NUMBER	NO. OF COMPARTMENTS	OPENING			OVERALL UNIT			WEIGHT	PRICE
		W	D	H	W	D	H		
WITH LEGS									
VBL6-1218-1♣	6	12	18	12	12	18	78	104	\$688.00
VBL6-1218-3♣	18	12	18	12	36	18	78	274	1,705.00
WITHOUT LEGS									
VBL6-1218-A	6	12	18	12	12	18	72	102	682.00
VBL6-1218-C	18	12	18	12	36	18	72	269	1,674.00

Shipped assembled.
National Motor Freight Class: 175

Standard Colors



Items with this symbol are available to ship in 2-3 days. Limited quantities and select colors.



(MGY)

COST FOR PERFORATION ON DOORS

CAT. NO.	DESCRIPTION	PERFORATION COST*
LPDS-12	SINGLE TIER DOOR 12" WIDE	\$7.30
LPDS-15	SINGLE TIER DOOR 15" WIDE	7.40
LPDD-12	DOUBLE TIER DOOR 12" WIDE	3.40
LPDD-15	DOUBLE TIER DOOR 15" WIDE	3.90
LPDT-12	TRIPLE TIER DOOR 12" WIDE	5.30
LPDT-15	TRIPLE TIER DOOR 15" WIDE	5.70
LPDB-12	BOX DOOR 12" WIDE	1.50
LPDB-15	BOX DOOR 15" WIDE	6.90

*Cost listed is the additional cost for the door to be perforated. Lockers or Doors must be ordered separately. Perforation is available on all Tennsco lockers with solid doors. For sizes not listed, call factory for pricing.

National Motor Freight Class: 85

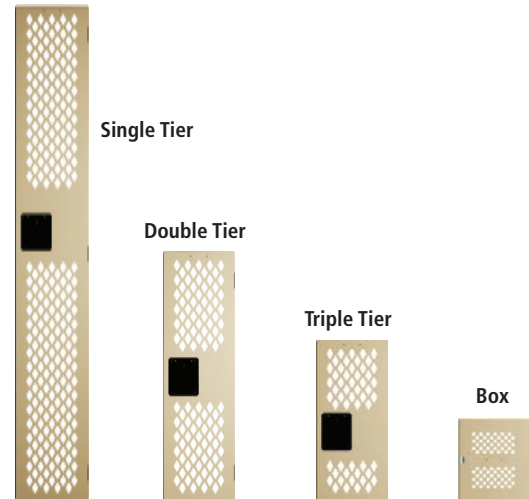

CAT. NO.	DOOR TYPE	W	H	WT.	PRICE
LSTD-1260	SINGLE TIER	12	60	20.0	\$162.00
LSTD-1560	SINGLE TIER	15	60	23.0	161.00
LSTD-1272	SINGLE TIER	12	72	23.0	149.00
LSTD-1572	SINGLE TIER	15	72	27.0	166.00
LSTD-1872	SINGLE TIER	18	72	31.0	190.00
LDTD-1230	DOUBLE TIER	12	30	9.3	76.00
LDTD-1236	DOUBLE TIER	12	36	11.0	81.00
LDTD-1536	DOUBLE TIER	15	36	12.8	90.00
LTDD-1224	TRIPLE TIER	12	24	5.0	75.00
LBD-1212	BOX	12	12	3.1	11.90
LBD-1512	BOX	15	12	3.6	19.30

Lockbar and recessed cup included.

National Motor Freight Class: 85

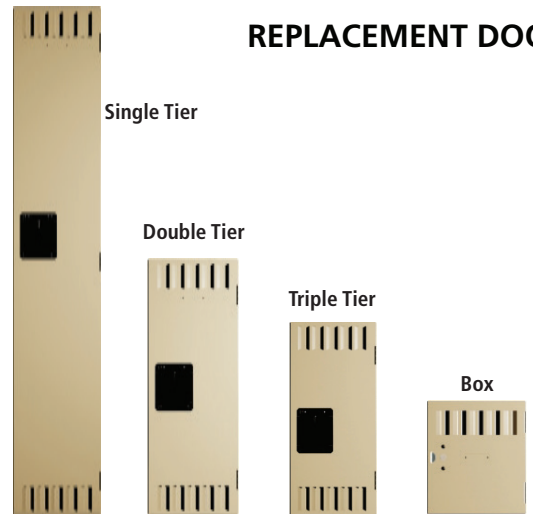

REPLACEMENT DOORS

REPLACEMENT DOOR FRAME ASSEMBLIES

CAT. NO.	DOOR TYPE	W	H	WT.	PRICE
LSFA-1260	SINGLE TIER	12	60	35.0	\$216.00
LSFA-1560	SINGLE TIER	15	60	34.0	218.00
LSFA-1272	SINGLE TIER	12	72	36.0	208.00
LSFA-1572	SINGLE TIER	15	72	40.0	227.00
LSFA-1872	SINGLE TIER	18	72	45.0	255.00
LSFA-2472	SINGLE TIER	24	72	60.0	342.00
LDFA-1260	DOUBLE TIER	12	60	34.0	225.00
LDFA-1272	DOUBLE TIER	12	72	37.0	238.00
LDFA-1572	DOUBLE TIER	15	72	42.0	258.00
LTFA-1272	TRIPLE TIER	12	72	35.0	360.00
LTFA-1572	TRIPLE TIER	12	72	38.0	382.00
LBFA-1260	BOX	12	60	29.0	167.00
LBFA-1272	BOX	12	72	24.0	189.00

Lockbar and recessed cup included.

Catalog numbers shown are for frames without legs. For frames with legs, add the suffix "-1".

National Motor Freight Class: 85

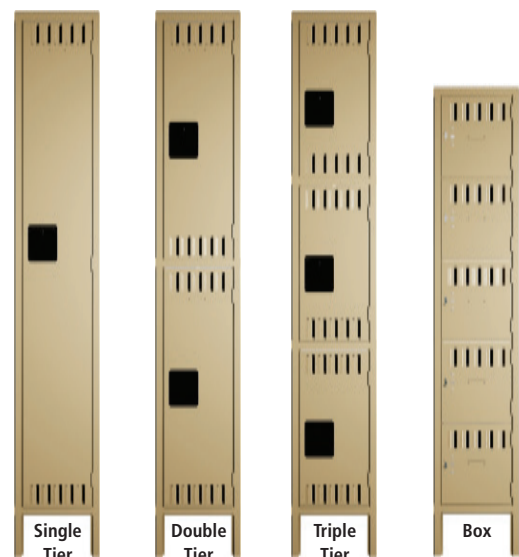

Standard Colors



Sand (SND) Champagne/ Putty (CPY) Light Grey (LGY) Medium Grey (MGY) Black (BLK)

FRONT AND END BASES



FRONT BASES					
CAT. NO.	W	D	H	WT.	PRICE
FB-12 ▲	12	—	6	1.2	\$6.20
FB-15 ▲	15	—	6	1.7	6.80
FB-18 ▲	18	—	6	2.0	8.20
FB-24	24	—	6	2.8	14.70

Use on lockers with legs.

END BASES					
CAT. NO.	W	D	H	WT.	PRICE
EB-12 ▲	—	12	6	1.2	\$9.90
EB-15 ▲	—	15	6	1.4	11.00
EB-18 ▲	—	18	6	1.7	10.80
EB-21	—	21	6	2.4	23.00
EB-24	—	24	6	2.6	23.00

National Motor Freight Class: 85

CLOSED BASES



ONE-WIDE BASES					
CAT. NO.	W	D	H	WT.	PRICE
CLB-1212	12	12	6	7.4	\$43.00
CLB-1215	12	15	6	7.3	46.00
CLB-1218 ▲	12	18	6	7.7	45.00
CLB-1518 ▲	15	18	6	8.5	55.00
CLB-1521	15	21	6	11.0	62.00

Leveling feet included. Use on lockers without legs.

THREE-WIDE BASES					
CAT. NO.	W	D	H	WT.	PRICE
CLB-3612 ▲	36	12	6	13.1	\$87.00
CLB-3615 ▲	36	15	6	16.3	90.00
CLB-3618 ▲	36	18	6	19.6	88.00
CLB-4512	45	12	6	16.3	96.00
CLB-4515	45	15	6	20.4	101.00
CLB-4518	45	18	6	17.0	104.00

National Motor Freight Class: 85

Z-BASES



The shape of the Z-Base provides a recessed front base and toe-plate.

CAT. NO.	W	D	H	WT.	PRICE
Z-BASE FRONT					
LZBA-12	12	1 5/8	4	1.7	\$23.00
LZBA-36	36	1 5/8	4	5.5	34.00
LZBA-72	72	1 5/8	4	12.0	52.00
Z-BASE SIDE					
LZBS-18	—	18	4	4.8	15.50
SPLICE PLATE					
LZBSPL	3 1/2	—	3 3/4	0.8	2.50

NOTE: Z-Base only supports front of locker, creating a 4" space beneath the locker. Locker must be anchored to a wall or back-to-back.

National Motor Freight Class: 85

LAMINATE HARD MAPLE BENCHES & BENCH PEDESTALS



NOTE: Pedestals must be ordered separately.

*Use three pedestals for benches 108" to 144".

CAT. NO.	W	D	H	WT.	PRICE
HMLB-36	36	9 1/2	1 1/4	10.0	\$119.00
HMLB-48	48	9 1/2	1 1/4	16.0	159.00
HMLB-60	60	9 1/2	1 1/4	20.0	192.00
HMLB-72	72	9 1/2	1 1/4	20.0	230.00
HMLB-84	84	9 1/2	1 1/4	28.0	268.00
HMLB-96	96	9 1/2	1 1/4	32.0	313.00
HMLB-108*	108	9 1/2	1 1/4	36.0	349.00
HMLB-120*	120	9 1/2	1 1/4	40.0	399.00
HMLB-132*	132	9 1/2	1 1/4	44.0	428.00
HMLB-144*	144	9 1/2	1 1/4	48.0	497.00
LBP-1 (BENCH PEDESTAL) ▲			16 1/4	7.0	53.00

Color options not available for HMLB-ww.

National Motor Freight Class: 85

SHELVES FOR STANDARD LOCKERS



CAT. NO.	W	D	H	WT.	PRICE
ESL-1212	12	12	3/4	1.3	\$24.00
ESL-1215	12	15	3/4	1.9	25.00
ESL-1218	12	18	3/4	2.2	25.00
ESL-1518	15	18	3/4	2.4	27.00
ESL-1521	15	21	3/4	3.3	32.00
ESL-1821	18	21	3/4	3.8	33.00
ESL-2424	24	24	3/4	4.6	39.00

National Motor Freight Class: 85

Standard Colors (Unless Otherwise Specified)



▲ Items with this symbol are available to ship in 2-3 days. Limited quantities and select colors.



Locker Accessories

COAT RODS & COAT HOOKS

CAT. NO.	W	D	H	WT.	PRICE
COAT RODS*					
LCR-12	12	—	—	0.4	\$2.20
LCR-15	15	—	—	0.4	2.40
LCR-18	18	—	—	0.5	2.80
LCR-21	21	—	—	0.6	3.20
LCR-24	24	—	—	0.7	3.20
COAT HOOKS					
LCH-1	SINGLE COAT HOOK			0.1	2.20
LCH-2	DOUBLE COAT HOOK**			0.2	3.70



*Coat rods are available in Medium Grey only.
**Double Coat Hook can not be used with coat rod.

National Motor Freight Class: 85

CAT. NO.	DESCRIPTION	WT.	PRICE
LLCA-1	FOR SINGLE TIER	1.0	\$11.70
LLCA-2	FOR DOUBLE TIER	0.5	9.70
LLCA-3	FOR TRIPLE TIER	0.4	9.30

LOCKING CHANNELS



Locking Channels are a vertical product, but shown horizontal for clarity of detail. Available in Medium Grey only.

National Motor Freight Class: 85

CAT. NO.	DESCRIPTION	WT.	PRICE
LRH-2	PAINTED STEEL	0.7	\$6.60
LRH-3	STAINLESS STEEL	0.7	16.70

RECESSED HANDLES



Color options not available.

National Motor Freight Class: 85

CAT. NO.	DESCRIPTION	WT.	PRICE
LL-3	LATCH AND SPRING	0.1	\$1.40
LPR-2	PADLOCK RECEIVER	0.3	4.00
LB-1	DOOR BUMPER	0.1	1.50
LDC-1	DART CLIP	0.1	0.71
LRT-1	REINFORCEMENT TAB	0.2	1.60
LTUP-1	TOUCH-UP PAINT	0.3	9.20

MISCELLANEOUS REPLACEMENT PARTS

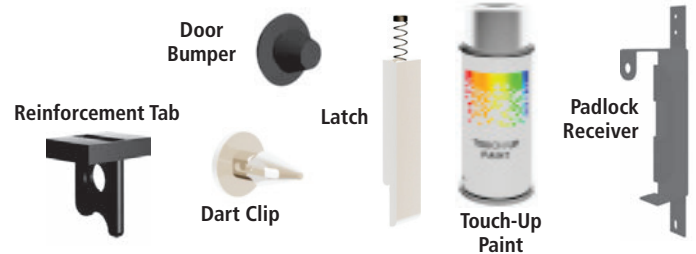

Color options not available, except for Touch-Up Paint.

National Motor Freight Class: 85

All locks can be used on any Tennsco locker except where noted.

CAT. NO.	DESCRIPTION	WT.	PRICE*
GROOVED KEY LOCK			
MAS-1710MK	GROOVED KEY LOCK (DEAD BOLT)	0.4	\$47.00
COMBINATION LOCKS			
MAS-1670	DEAD BOLT (MASTER KEYED)	0.5	56.00
MAS-1654	SPRING BOLT (MASTER KEYED)	0.5	55.00
MAS-1630*	GRAVITY LIFT LOCK (MASTER KEYED)	0.5	48.00
COMBINATION PADLOCKS			
MAS-1525	COMBINATION (MASTER KEYED)	0.5	25.00
MAS-1502	COMBINATION (NO KEY)	0.5	17.70

Master keyed locks are shipped with two master keys per order. To order additional master keys, see "Keys" (below).

*NOTE: Gravity Lift Locks do not work on box lockers.

Color options not available.

LOCKS BY MASTER LOCK

GROOVED KEY LOCK



COMBINATION LOCKS



DEAD BOLT SPRING BOLT GRAVITY LIFT

COMBINATION PADLOCKS



MASTER KEYED

NO KEY

KEYS

Color options not available.



CAT. NO.	KEY TYPE	FITS LOCK TYPE	PRICE*
LMCK-1	MASTER KEY (FITS ALL LOCKS IN A SERIES)	COMBINATION LOCK	\$18.30
LMPK-1	MASTER KEY (FITS ALL LOCKS IN A SERIES)	COMBINATION PADLOCK	18.30
LMGK-1	MASTER KEY (FITS ALL LOCKS IN A SERIES)	GROOVED KEY	18.30

National Motor Freight Class: 85

NUMBER PLATES & NAME PLATES



LNP-A



LNP-2

Color options not available.

National Motor Freight Class: 85

CAT. NO.	DESCRIPTION	WT.	PRICE
NUMBER PLATES*			
LNP-A	ALUMINUM NUMBER PLATES (25)	2.5	42.50
NAME PLATE**			
LNP-2	TENNSCO NAME PLATE	0.1	1.50

*Available only in series of 25 (example: 1-25, 26-50, 51-75, etc.) ranging from 1 through 1999. Must specify number groups when ordering. A pop rivet gun is needed for installation.

**Custom black plastic plates are available, but must be special-ordered and require a longer lead time. Call for pricing and availability.

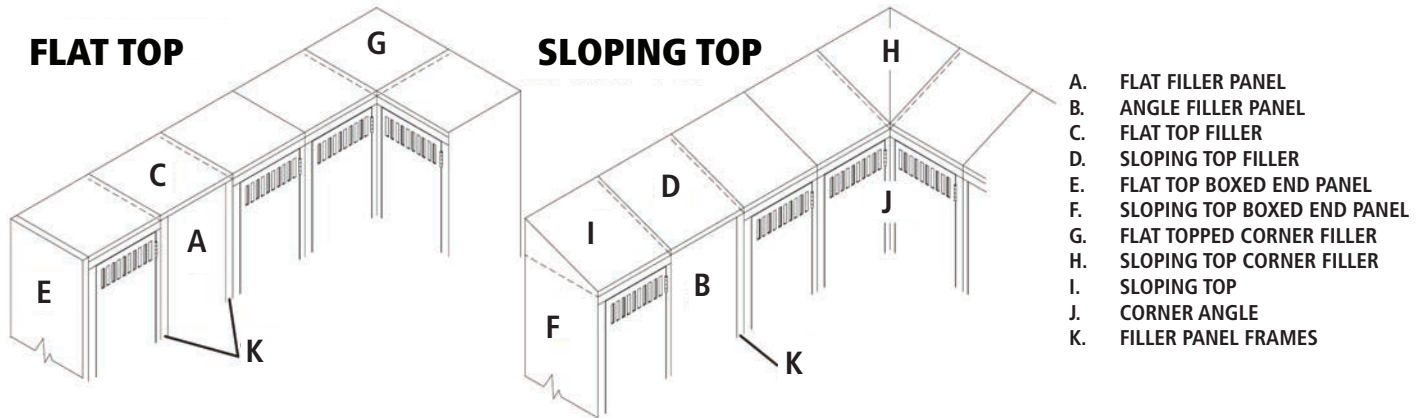

FLAT AND ANGLE FILLER PANELS



Flat Filler Panel

FLAT FILLER PANELS (A)					
CAT. NO.	W	D	H	WT.	PRICE
LFF-360	3	—	60	11.2	\$65.00
LFF-366	3	—	66	11.4	65.00
LFF-372	3	—	72	11.6	66.00
LFF-378	3	—	78	11.8	66.00
LFF-960	9	—	60	14.8	77.00
LFF-966	9	—	66	15.4	80.00
LFF-972	9	—	72	15.9	82.00
LFF-978	9	—	78	16.4	84.00
LFF-1760	17	—	60	19.8	95.00
LFF-1766	17	—	66	21.0	99.00
LFF-1772	17	—	72	22.0	102.00
LFF-1778	17	—	78	23.0	131.00

TWO FILLER PANEL FRAMES MUST BE USED



Angle Filler Panel

ANGLE FILLER PANELS (B)					
CAT. NO.	W	D	H	WT.	PRICE
LAF-360	3	—	60	12.3	\$123.00
LAF-366	3	—	66	12.5	123.00
LAF-372	3	—	72	12.8	124.00
LAF-378	3	—	78	13.1	125.00
LAF-960	9	—	60	16.0	136.00
LAF-966	9	—	66	16.7	138.00
LAF-972	9	—	72	17.3	141.00
LAF-978	9	—	78	18.0	143.00
LAF-1760	17	—	60	21.0	154.00
LAF-1766	17	—	66	22.0	157.00
LAF-1772	17	—	72	23.0	134.00
LAF-1778	17	—	78	25.0	165.00

ONE FILLER PANEL FRAME MUST BE USED

National Motor Freight Class: 85

FLAT AND SLOPING TOP FILLERS



FLAT TOP FILLERS (C)					
CAT. NO.	W	D	H	WT.	PRICE
LFTF-312	3	12	—	2.0	\$47.00
LFTF-315	3	15	—	2.1	48.00
LFTF-318	3	18	—	2.2	48.00
LFTF-321	3	21	—	2.4	48.00
LFTF-324	3	24	—	2.6	49.00
LFTF-912	9	12	—	2.7	49.00
LFTF-915	9	15	—	2.9	50.00
LFTF-918	9	18	—	3.2	51.00
LFTF-921	9	21	—	3.5	52.00
LFTF-924	9	24	—	3.8	52.00
LFTF-1712	17	12	—	3.6	52.00
LFTF-1715	17	15	—	4.0	53.00
LFTF-1718	17	18	—	4.5	55.00
LFTF-1721	17	21	—	5.0	57.00
LFTF-1724	17	24	—	5.5	58.00

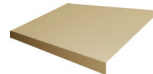

SLOPING TOP FILLERS (D)					
CAT. NO.	W	D	H	WT.	PRICE
LSTF-312	3	12	—	2.0	\$50.00
LSTF-315	3	15	—	2.1	50.00
LSTF-318	3	18	—	2.2	51.00
LSTF-321	3	21	—	2.4	51.00
LSTF-324	3	24	—	2.5	51.00
LSTF-912	9	12	—	2.7	52.00
LSTF-915	9	15	—	2.9	53.00
LSTF-918	9	18	—	3.2	53.00
LSTF-921	9	21	—	3.5	55.00
LSTF-1712	17	12	—	3.6	55.00
LSTF-1715	17	15	—	4.1	57.00
LSTF-1718	17	18	—	4.0	58.00
LSTF-1721	17	21	—	5.0	60.00
LSTF-1724	17	24	—	5.5	61.00

National Motor Freight Class: 85

Standard Colors



Sand (SND) Champagne/ Putty (CPY) Light Grey (LGY) Medium Grey (MGY) Black (BLK)

BOXED END PANELS

FLAT TOP BOXED END PANELS (E)					
CAT. NO.	W	D	H	WT.	PRICE
LFTBE-1260	—	12	60	28	\$144.00
LFTBE-1560	—	15	60	31	155.00
LFTBE-1860	—	18	60	34	166.00
LFTBE-2160	—	21	60	38	177.00
LFTBE-1266	—	12	66	30	149.00
LFTBE-1566	—	15	66	33	161.00
LFTBE-1866	—	18	66	37	171.00
LFTBE-2166	—	21	66	40	185.00
LFTBE-1272	—	12	72	32	155.00
LFTBE-1572	—	15	72	35	168.00
LFTBE-1872	—	18	72	39	181.00
LFTBE-2172	—	21	72	43	194.00
LFTBE-1278	—	12	78	33	157.00
LFTBE-1578	—	15	78	37	174.00
LFTBE-1878	—	18	78	41	189.00
LFTBE-2178	—	21	78	46	203.00



Flat Top
Boxed End Panel

SLOPING TOP BOXED END PANELS (F)					
CAT. NO.	W	D	H	WT.	PRICE
LSTBE-1260	—	12	60	29	\$171.00
LSTBE-1560	—	15	60	33	183.00
LSTBE-1860	—	18	60	37	198.00
LSTBE-2160	—	21	60	41	213.00
LSTBE-1266	—	12	66	31	177.00
LSTBE-1566	—	15	66	35	191.00
LSTBE-1866	—	18	66	40	207.00
LSTBE-1272	—	12	72	33	185.00
LSTBE-1572	—	15	72	37	198.00
LSTBE-1872	—	18	72	41	215.00
LSTBE-2172	—	21	72	46	230.00
LSTBE-1278	—	12	78	34	191.00
LSTBE-1578	—	15	78	39	205.00
LSTBE-1878	—	18	78	44	206.00
LSTBE-2178	—	21	78	49	239.00



Sloping Top
Boxed End Panel

NOTE: For left sloping panels, add -L to the catalog number; for right sloping panels, add -R to the catalog number.

National Motor Freight Class: 85

CORNER FILLERS

FLAT TOP CORNER FILLERS (G)					
CAT. NO.	W	D	H	WT.	PRICE
LFCF-12	—	12	—	3.5	\$51.00
LFCF-15	—	15	—	4.5	56.00
LFCF-18	—	18	—	5.3	58.00
LFCF-21	—	21	—	6.2	61.00
LFCF-24	—	24	—	7.2	66.00



Flat Top
Corner Filler

SLOPING TOP CORNER FILLERS (H)					
CAT. NO.	W	D	H	WT.	PRICE
LSCF-12	—	12	—	3.5	\$63.00
LSCF-15	—	15	—	4.4	66.00
LSCF-18	—	18	—	5.5	70.00
LSCF-21	—	21	—	6.7	73.00
LSCF-24	—	24	—	7.7	77.00



Sloping Top
Corner Filler

National Motor Freight Class: 85

SLOPING TOP — ONE WIDE (I)					
CAT. NO.	W	D	H	WT.	PRICE
KST-1212▲	12	12	—	3.6	\$44.00
KST-1215▲	12	15	—	4.3	55.00
KST-1218▲	12	18	—	5.0	53.00
KST-1518▲	15	18	—	5.5	58.00
KST-1521	15	21	—	7.6	74.00
KST-1821	18	21	—	7.9	77.00
KST-2424	24	24	—	9.1	121.00



Sloping Top
One Wide

SLOPING TOP — THREE WIDE (I)					
CAT. NO.	W	D	H	WT.	PRICE
KST-3612▲	36	12	—	7.7	\$57.00
KST-3615▲	36	15	—	9.0	64.00
KST-3618▲	36	18	—	10.1	69.00
KST-4518▲	45	18	—	13.4	77.00
KST-4521	45	21	—	15.0	116.00



Sloping Top
Three Wide

*All sloping tops are shipped unassembled only.

National Motor Freight Class: 85

CORNER ANGLES

CORNER ANGLE (J)					
CAT. NO.	W	D	H	WT.	PRICE
LCAF-60	—	—	60	3.9	\$32.00
LCAF-66	—	—	66	4.2	34.00
LCAF-72	—	—	72	4.6	35.00
LCAF-78	—	—	78	4.8	36.00



Corner Angles are a vertical product, but shown horizontal for clarity of detail.

National Motor Freight Class: 85

FILLER PANEL FRAMES

FILLER PANEL FRAMES (K)					
CAT. NO.	W	D	H	WT.	PRICE
LFPP-60	—	—	60	3.4	\$49.00
LFPP-66	—	—	66	3.7	50.00
LFPP-72	—	—	72	4.0	51.00
LFPP-78	—	—	78	4.4	52.00



Filler Panel Frames are a vertical product, but shown horizontal for clarity of detail.

National Motor Freight Class: 85

Standard Colors



▲ Items with these symbols are available to ship in 2-3 days. Limited quantities and select colors.



LOCKERS

Locker Accessories

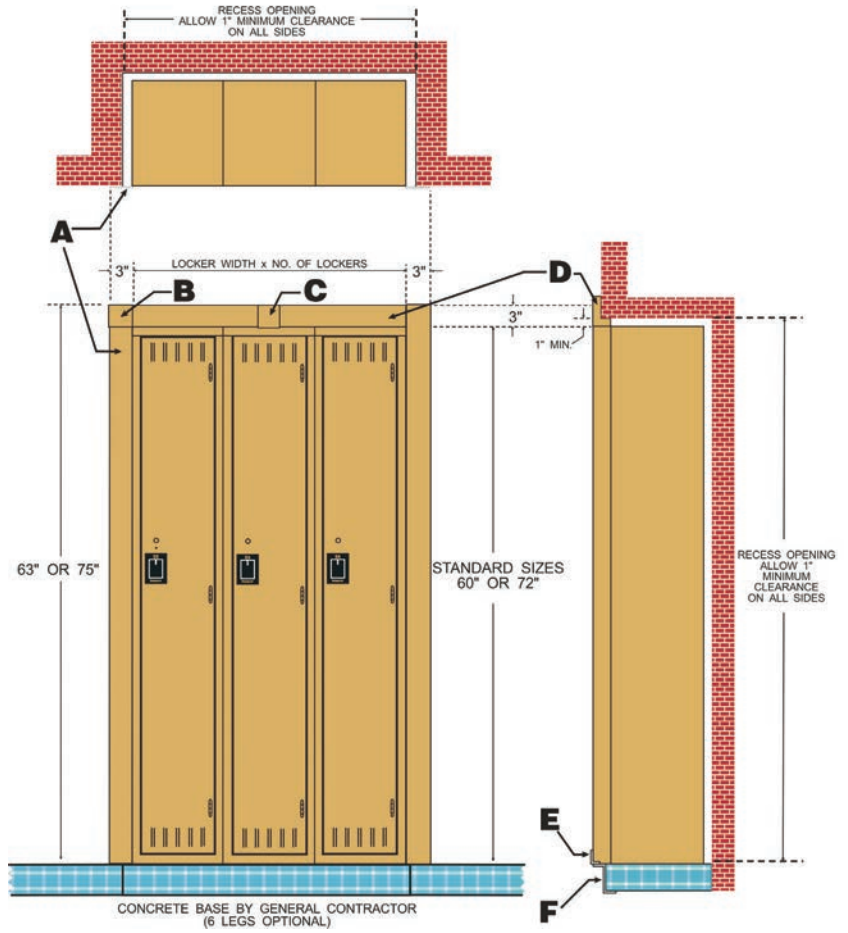

- A. VERTICAL TRIM
- B. CORNER SPLICE CAP
- C. SPLICE CAP
- D. HORIZONTAL TRIM
- E. BOTTOM ANGLE
- F. Z-BRACE

LOCKERS

TRIM

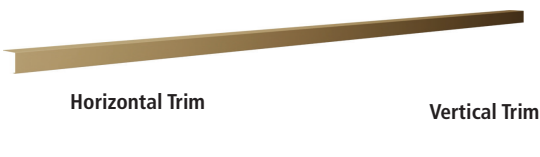

CAT. NO.	DESCRIPTION	W	D	H	WT.	PRICE
LHT-72	HORIZONTAL TRIM	72	—	3	5.6	\$49.00
LVT-60L	VERTICAL TRIM	3	—	60	6.2	49.00
LVT-60R	VERTICAL TRIM	3	—	60	6.2	49.00
LVT-72L	VERTICAL TRIM	3	—	72	7.4	49.00
LVT-72R	VERTICAL TRIM	3	—	72	7.4	49.00

National Motor Freight Class: 85

CAPS



CAT. NO.	DESCRIPTION	W	D	H	WT.	PRICE
LSC-1	SPLICE CAP	3	—	3	0.2	\$18.20
LCSC-1	CORNER SPLICE CAP	4	—	4	0.3	28.00
LOCC-1	OUTSIDE CORNER CAP	3	—	6	0.3	25.00

National Motor Freight Class: 85

BRACES & COVERS

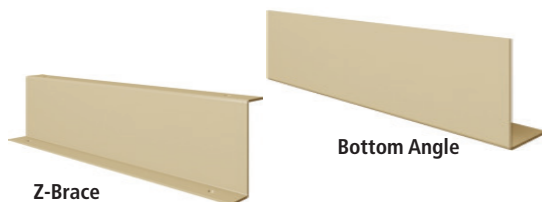

CAT. NO.	DESCRIPTION	W	D	H	WT.	PRICE
LZB-12	Z-BRACE	—	12	3	1.5	\$26.00
LZB-15	Z-BRACE	—	15	3	1.9	27.00
LZB-18	Z-BRACE	—	18	3	2.2	28.00
LBA-12	BOTTOM ANGLE	2	12	—	1.3	25.00
LBA-15	BOTTOM ANGLE	2	15	—	1.6	26.00
LBA-18	BOTTOM ANGLE	2	18	—	1.9	27.00

National Motor Freight Class: 85

Standard Colors



ADA COMPLIANT LOCKERS



Tensco ADA Compliant Lockers are specifically designed to provide easier access to contents from a seated position. This is achieved through your choice of a bottom riser to raise the lower shelf, an ADA compliant keyless lock, and reduced-height upper shelf and coat hooks.

The special ADA compliant lock allows the locker to be opened by simply inserting the key. No turning of the key is required, allowing for single-handed operation.

The bottom riser raises items stored on the bottom shelf to a more reachable level.

The reduced height upper shelf and coat hooks bring items normally stored high in the locker down to a reachable level.

Tensco will modify several of our standard lockers, offering a variety of choices. ADA Compliant Lockers are available for single tier, double tier (bottom locker only), and triple tier (bottom two lockers only) lockers, and can be custom ordered with the ADA features below. Call factory for details. You may also convert your existing lockers to be ADA compliant by ordering the options below.

All ADA Compliant Lockers are shipped with the universal handicap symbol.

Call factory for ADA Lock options.

ADA REDUCED HEIGHT UPPER SHELVES

CAT. NO.	W	D	H	WT.	PRICE
ADALS-1212	12	12	—	2.9	\$19.70
ADALS-1215	12	15	—	3.3	18.10
ADALS-1218	12	18	—	3.9	20.00
ADALS-1518	15	18	—	4.6	24.00
ADALS-1521	15	21	—	5.2	32.00

Shelf includes three coat hooks. May require drilling for installation.

National Motor Freight Class: 85



ADA BOTTOM RISERS

CAT. NO.	W	D	H	WT.	PRICE
ADALSI-1212	12	12	—	2.9	\$19.70
ADALSI-1215	12	15	—	3.3	18.10
ADALSI-1218	12	18	—	3.8	20.00
ADALSI-1518	15	18	—	4.6	24.00
ADALSI-1521	15	21	—	5.2	32.00

For adequate height, must be used only with lockers with legs, or with no-leg lockers installed on a closed base.

National Motor Freight Class: 85



ADA STICKER

CAT. NO.	W	D	H	WT.	PRICE
ADA-STK	2	—	2	0.1	\$5.70

Color options not available.

National Motor Freight Class: 85



Standard Colors (Unless Otherwise Specified)



Sand (SND) Champagne/ Putty (CPY) Light Grey (LGY) Medium Grey (MGY) Black (BLK)

Specialty Lockers

CUBBIES



CAT. NO.	# OF OPENINGS	W	D	H	WT.	PRICE
CC-30	6	34 1/2	13 1/2	30	56.0	\$464.00
CC-40	9	34 1/2	13 1/2	40	76.0	591.00
CC-52	12	34 1/2	13 1/2	52	97.0	746.00
CC-66	15	34 1/2	13 1/2	66	120.0	873.00
CC-78	18	34 1/2	13 1/2	78	140.0	972.00
CLEAR BINS FOR CUBBIES						
CCB-2	-	10 3/32	13 3/4	2 1/4	3.8	37.00
CCB-4	-	10 3/32	13 3/4	4 1/4	4.2	40.00
CCB-6	-	10 3/32	13 3/4	6 1/4	4.5	44.00
CCB-8	-	10 3/32	13 3/4	8 1/4	4.8	47.00
EXTRA CUBBY SHELF WITH 4 SHELF CLIPS						
ECS-1	-	10	12 3/4	3/4	1.6	11.70
EXTRA SHELF CLIP						
CCC-1	-	-	-	-	0.1	.60
EXTRA COAT HOOK						
LCH-2	-	-	-	-	0.2	3.70

3 coat hooks included per unit. Shipped assembled.

Standard Cubby Colors

National Motor Freight Class: 175



FIRST RESPONSE LOCKER



CAT. NO.	W	D	H	WT.	PRICE
PLSTS-243690-A	36	24	90	379.0	\$3,168.00
NUMBER PLATES*					
LNP-A	ALUMINUM NUMBER PLATES (25)			2.5	42.50

*Available only in series of 25 (example: 1-25, 26-50, 51-75, etc.) ranging from 1 through 1999. Must specify number groups when ordering. A pop rivet gun is needed for installation.

National Motor Freight Class: 175

CELL PHONE LOCKERS



CATALOG NUMBER	NO. OF COMPARTMENTS	OPENING			OVERALL UNIT			WEIGHT	PRICE
		W	D	H	W	D	H		
10 DOORS HIGH									
CP10-091572-A	10	9	15	7	9	15	83	107	\$1,146.00
CP10-091572-D	40	9	15	7	36	15	83	246	3,226.00
12 DOORS HIGH									
CP12-091572-A	12	9	15	6	9	15	83	112	1,145.00
CP12-091572-D	48	9	15	6	36	15	83	264	3,309.00
NUMBER PLATES*									
LNP-A	ALUMINUM NUMBER PLATES (25)							2.5	42.50

*Available only in series of 25 (example: 1-25, 26-50, 51-75, etc.) ranging from 1 through 1999. Must specify number groups when ordering. A pop rivet gun is needed for installation.

Shipped Assembled.

National Motor Freight Class: 175

Standard Colors (Unless Otherwise Specified)



Z-Line Low Profile Shelving



STARTER UNIT WITH DECKING



ADDER UNIT WITH DECKING

Starter units use four EUR uprights and six DRS end supports; adder units use two ZTP uprights and three DRS end supports. Shelves are supported, on front and rear only, by low profile shelf supports (DRS-ww). 36" deep shelves are supported on all four sides.

4 SHELVES, 3 OPENINGS - With Particleboard Decking - Assembly required.

UNIT SIZE			SHELF LOAD CAPACITY*	STARTER UNITS			ADDER UNITS			EXTRA SHELF LEVEL		
W	D	H		CAT NO.	WT.	PRICE	CAT NO.	WT.	PRICE	CAT NO.	WT.	PRICE
36	12	84	600	ZA7-3612S-4D ▲	65.0	\$167.00	ZA7-3612A-4D ▲	63.0	\$157.00	ZAES-3612D ▲	10.9	\$19.70
42	12	84	550	ZA7-4212S-4D ▲	73.0	181.00	ZA7-4212A-4D ▲	71.0	170.00	ZAES-4212D ▲	12.8	23.00
48	12	84	500	ZA7-4812S-4D ▲	80.0	189.00	ZA7-4812A-4D ▲	78.0	179.00	ZAES-4812D ▲	14.6	25.00
36	18	84	600	ZA7-3618S-4D ▲	83.0	185.00	ZA7-3618A-4D ▲	80.0	172.00	ZAES-3618D ▲	14.7	23.00
42	18	84	550	ZA7-4218S-4D ▲	93.0	202.00	ZA7-4218A-4D ▲	89.0	189.00	ZAES-4218D ▲	17.1	27.00
48	18	84	500	ZA7-4818S-4D ▲	103.0	211.00	ZA7-4818A-4D ▲	99.0	198.00	ZAES-4818D ▲	19.6	29.00
36	24	84	600	ZA7-3624S-4D ▲	99.0	201.00	ZA7-3624A-4D ▲	95.0	188.00	ZAES-3624D ▲	18.4	27.00
42	24	84	550	ZA7-4224S-4D ▲	111.0	218.00	ZA7-4224A-4D ▲	107.0	205.00	ZAES-4224D ▲	22.0	31.00
48	24	84	500	ZA7-4824S-4D ▲	124.0	225.00	ZA7-4824A-4D ▲	120.0	212.00	ZAES-4824D ▲	25.0	33.00
36	36	84	600	ZA7-3636S-4D ▲	136.0	248.00	ZA7-3636A-4D ▲	135.0	249.00	ZAES-3636D ▲	29.0	48.00
42	36	84	550	ZA7-4236S-4D ▲	154.0	268.00	ZA7-4236A-4D ▲	153.0	269.00	ZAES-4236D ▲	34.0	55.00
48	36	84	500	ZA7-4836S-4D ▲	175.0	283.00	ZA7-4836A-4D ▲	174.0	283.00	ZAES-4836D ▲	38.0	57.00

*Load capacity in pounds per shelf level, evenly distributed. Total unit capacity, using four uprights, not to exceed 8,000 lbs., based on 24" centers or less.

4 SHELVES, 3 OPENINGS - Without Decking - Assembly required.

UNIT SIZE			SHELF LOAD CAPACITY*	STARTER UNITS			ADDER UNITS			EXTRA SHELF LEVEL		
W	D	H		CAT NO.	WT.	PRICE	CAT NO.	WT.	PRICE	CAT NO.	WT.	PRICE
36	12	84	600	ZA7-3612S-4 ▲	35.0	\$139.00	ZA7-3612A-4 ▲	33.0	\$130.00	ZAES-3612 ▲	3.4	\$12.70
42	12	84	550	ZA7-4212S-4 ▲	38.0	145.00	ZA7-4212A-4 ▲	36.0	137.00	ZAES-4212 ▲	4.0	14.40
48	12	84	500	ZA7-4812S-4 ▲	40.0	152.00	ZA7-4812A-4 ▲	38.0	143.00	ZAES-4812 ▲	4.6	16.00
36	18	84	600	ZA7-3618S-4 ▲	38.0	146.00	ZA7-3618A-4 ▲	34.0	133.00	ZAES-3618 ▲	3.4	12.80
42	18	84	550	ZA7-4218S-4 ▲	40.0	152.00	ZA7-4218A-4 ▲	37.0	139.00	ZAES-4218 ▲	4.0	14.40
48	18	84	500	ZA7-4818S-4 ▲	43.0	158.00	ZA7-4818A-4 ▲	39.0	146.00	ZAES-4818 ▲	4.6	16.00
36	24	84	600	ZA7-3624S-4 ▲	39.0	146.00	ZA7-3624A-4 ▲	35.0	133.00	ZAES-3624 ▲	3.4	12.80
42	24	84	550	ZA7-4224S-4 ▲	41.0	152.00	ZA7-4224A-4 ▲	37.0	139.00	ZAES-4224 ▲	4.0	14.40
48	24	84	500	ZA7-4824S-4 ▲	44.0	159.00	ZA7-4824A-4 ▲	40.0	146.00	ZAES-4824 ▲	4.6	16.00
36	36	84	600	ZA7-3636S-4 ▲	46.0	170.00	ZA7-3636A-4 ▲	45.0	170.00	ZAES-3636 ▲	6.8	28.00
42	36	84	550	ZA7-4236S-4 ▲	48.0	176.00	ZA7-4236A-4 ▲	48.0	177.00	ZAES-4236 ▲	7.6	31.00
48	36	84	500	ZA7-4836S-4 ▲	51.0	183.00	ZA7-4836A-4 ▲	50.0	184.00	ZAES-4836 ▲	8.0	29.00

*Load capacity in pounds per shelf level, evenly distributed. Total unit capacity, using four uprights, not to exceed 8,000 lbs., based on 24" centers or less.

National Motor Freight Class: 70

Standard Colors



▲
Items with these symbols are available to ship in 2-3 days. Limited quantities and select colors.



SHELVING

Z-Line Long Span Shelving

LONG SPAN SHELVING



Heavy duty long span units include 3 shelf levels. Units use SUR uprights. Shelves supported on all four sides with heavy duty profile shelf supports (LRA-xx).

UNIT SIZE			SHELF LOAD CAPACITY*	REINFORCEMENTS PER LEVEL	UNITS WITH DECKING			EXTRA SHELF LEVEL		
W	D	H			CAT NO.	WT.	PRICE	CAT NO.	WT.	PRICE
48	24	84	2,250	1	ZL7-4824-3D▲	125.0	\$286.00	ZLES-4824D▲	33.0	\$65.00
60	24	84	2,000	1	ZL7-6024-3D▲	146.0	321.00	ZLES-6024D▲	40.0	76.00
72	24	84	1,750	2	ZL7-7224-3D▲	173.0	391.00	ZLES-7224D▲	49.0	100.00
96	24	84	1,250	3	ZL7-9624-3D▲	220.0	476.00	ZLES-9624D▲	65.0	128.00
48	30	84	2,250	1	ZL7-4830-3D▲	144.0	312.00	ZLES-4830D▲	39.0	73.00
60	30	84	2,000	1	ZL7-6030-3D▲	169.0	352.00	ZLES-6030D▲	48.0	87.00
72	30	84	1,750	2	ZL7-7230-3D▲	201.0	421.00	ZLES-7230D▲	58.0	110.00
96	30	84	1,250	3	ZL7-9630-3D▲	256.0	520.00	ZLES-9630D▲	77.0	143.00
48	36	84	2,250	1	ZL7-4836-3D▲	166.0	337.00	ZLES-4836D▲	47.0	82.00
60	36	84	2,000	1	ZL7-6036-3D▲	192.0	383.00	ZLES-6036D▲	55.0	97.00
72	36	84	1,750	2	ZL7-7236-3D▲	229.0	455.00	ZLES-7236D▲	68.0	121.00
96	36	84	1,250	3	ZL7-9636-3D▲	293.0	568.00	ZLES-9636D▲	89.0	159.00
48	48	84	2,250	1	ZL7-4848-3D▲	202.0	392.00	ZLES-4848D▲	59.0	100.00
60	48	84	2,000	1	ZL7-6048-3D▲	238.0	431.00	ZLES-6048D▲	71.0	114.00
72	48	84	1,750	2	ZL7-7248-3D▲	285.0	525.00	ZLES-7248D▲	86.0	144.00
96	48	84	1,250	3	ZL7-9648-3D▲	367.0	661.00	ZLES-9648D▲	114.0	190.00

UNIT SIZE			SHELF LOAD CAPACITY*	REINFORCEMENTS PER LEVEL	UNITS WITHOUT DECKING			EXTRA SHELF LEVEL		
W	D	H			CAT NO.	WT.	PRICE	CAT NO.	WT.	PRICE
48	24	84	2,250	1	ZL7-4824-3▲	65.0	\$236.00	ZLES-4824▲	13.1	\$48.00
60	24	84	2,000	1	ZL7-6024-3▲	71.0	255.00	ZLES-6024▲	15.1	54.00
72	24	84	1,750	2	ZL7-7224-3▲	83.0	304.00	ZLES-7224▲	19.0	71.00
96	24	84	1,250	3	ZL7-9624-3▲	100.0	371.00	ZLES-9624▲	25.0	93.00
48	30	84	2,250	1	ZL7-4830-3▲	69.0	251.00	ZLES-4830▲	14.4	52.00
60	30	84	2,000	1	ZL7-6030-3▲	75.0	270.00	ZLES-6030▲	16.4	59.00
72	30	84	1,750	2	ZL7-7230-3▲	88.0	325.00	ZLES-7230▲	21.0	77.00
96	30	84	1,250	3	ZL7-9630-3▲	106.0	393.00	ZLES-9630▲	27.0	99.00
48	36	84	2,250	1	ZL7-4836-3▲	73.0	263.00	ZLES-4836▲	15.8	57.00
60	36	84	2,000	1	ZL7-6036-3▲	79.0	283.00	ZLES-6036▲	17.8	63.00
72	36	84	1,750	2	ZL7-7236-3▲	94.0	338.00	ZLES-7236▲	23.0	82.00
96	36	84	1,250	3	ZL7-9636-3▲	113.0	412.00	ZLES-9636▲	29.0	107.00
48	48	84	2,250	1	ZL7-4848-3▲	82.0	289.00	ZLES-4848▲	18.6	65.00
60	48	84	2,000	1	ZL7-6048-3▲	88.0	308.00	ZLES-6048▲	21.0	72.00
72	48	84	1,750	2	ZL7-7248-3▲	105.0	374.00	ZLES-7248▲	26.0	93.00
96	48	84	1,250	3	ZL7-9648-3▲	127.0	454.00	ZLES-9648▲	34.0	121.00

*Load capacity in pounds per shelf level, evenly distributed. Total unit capacity not to exceed 13,000 lbs. per unit (3,250 lbs. per post) based on 24" centers or less.

National Motor Freight Class: 70

Standard Colors



▲ Items with this symbol are available to ship in 2-3 days. Limited quantities and select colors.



Z-Line Record Archive & Steel Shelf Units

RECORD ARCHIVE STORAGE RACKS



UNIT SIZE			NO. OF OPENINGS	SHELF LOAD CAPACITY*	UNITS WITHOUT DECKING			UNITS WITH DECKING		
W	D	H			CAT NO.	WT.	PRICE	CAT NO.	WT.	PRICE
42	15	60	2	2,250	ZA421560-3 ▲	41.0	\$152.00	ZA421560-3D ▲	73.0	\$181.00
69	15	60	2	1,800	ZA691560-3 ▲	57.0	211.00	ZA691560-3D ▲	111.0	260.00
42	15	84	3	2,250	ZA421584-4 ▲	55.0	205.00	ZA421584-4D ▲	98.0	244.00
69	15	84	3	1,800	ZA691584-4 ▲	76.0	285.00	ZA691584-4D ▲	148.0	350.00
42	30	60	2	2,250	ZA423060-3 ▲	47.0	171.00	ZA423060-3D ▲	113.0	225.00
69	30	60	2	1,800	ZA693060-3 ▲	67.0	239.00	ZA693060-3D ▲	175.0	347.00
42	30	84	3	2,250	ZA423084-4 ▲	64.0	230.00	ZA423084-4D ▲	151.0	302.00
69	30	84	3	1,800	ZA693084-4 ▲	90.0	322.00	ZA693084-4D ▲	234.0	466.00

*Load capacity figures are calculated in pounds per shelf level, evenly distributed. Total unit capacity, using four EUR uprights, not to exceed 8,000 lbs., based on 24" centers or less.

National Motor Freight Class: 70

STEEL SHELF UNITS



Starter and adder units include 5 shelf levels. Starter units use 4 EUR uprights; adder units use 2 ZTP uprights. Each unit is stabilized by VDRS shelf supports at both top and bottom. Intermediate shelves are attached by 4 ZSC-1 shelf clips. No sway braces required, allowing access from all 4 sides.

UNIT SIZE			SHELF LOAD CAPACITY*	STARTER UNITS			ADDER UNITS			EXTRA SHELF LEVEL		
W	D	H		CAT NO.	WT.	PRICE	CAT NO.	WT.	PRICE	CAT NO.	WT.	PRICE
36	12	84	750	ZM7-3612S-5D ♣	61.0	\$246.00	ZM7-3612A-5D ♣	59.0	\$240.00	ZMS-3612 ♣	6.7	\$28.00
42	12	84	600	ZM7-4212S-5D ♣	68.0	292.00	ZM7-4212A-5D ♣	66.0	286.00	ZMS-4212 ♣	7.7	36.00
48	12	84	500	ZM7-4812S-5D ♣	74.0	289.00	ZM7-4812A-5D ♣	72.0	283.00	ZMS-4812 ♣	8.7	35.00
36	18	84	750	ZM7-3618S-5D ♣	73.0	285.00	ZM7-3618A-5D ♣	70.0	277.00	ZMS-3618 ♣	8.8	35.00
42	18	84	600	ZM7-4218S-5D ♣	81.0	326.00	ZM7-4218A-5D ♣	78.0	318.00	ZMS-4218 ♣	10.1	42.00
48	18	84	500	ZM7-4818S-5D ♣	89.0	338.00	ZM7-4818A-5D ♣	86.0	330.00	ZMS-4818 ♣	11.4	44.00
36	24	84	700	ZM7-3624S-5D ♣	85.0	324.00	ZM7-3624A-5D ♣	82.0	313.00	ZMS-3624 ♣	10.9	42.00
42	24	84	550	ZM7-4224S-5D ♣	95.0	370.00	ZM7-4224A-5D ♣	91.0	359.00	ZMS-4224 ♣	12.5	50.00
48	24	84	450	ZM7-4824S-5D ♣	104.0	387.00	ZM7-4824A-5D ♣	100.0	376.00	ZMS-4824 ♣	14.1	53.00
36	36	84	600	ZM7-3636S-5D ♣	122.0	494.00	ZM7-3636A-5D ♣	118.0	473.00	ZMS-3636 ♣	17.9	74.00
42	36	84	550	ZM7-4236S-5D ♣	137.0	530.00	ZM7-4236A-5D ♣	132.0	515.00	ZMS-4236 ♣	21.0	80.00
48	36	84	450	ZM7-4836S-5D ♣	150.0	572.00	ZM7-4836A-5D ♣	146.0	557.00	ZMS-4836 ♣	23.0	88.00

*Load capacity figures are calculated in pounds per shelf level, evenly distributed. Total unit capacity, using four EUR uprights, not to exceed 8,000 lbs., based on 24" centers or less.

National Motor Freight Class: 70

Standard Colors



▲ ♣
Items with these symbols are available to ship in 2-3 days. Limited quantities and select colors.

▲ (SND) (MGY)
♣ (MGY)

Z-Line Sloping Shelf & Tire Rack Units

SLOPING SHELF UNITS (FLAT SLOPE STYLE)



Includes 5 sloped shelves and one top shelf.



Units can be placed back to back for double entry (shown).

UNIT SIZE			SHELF LOAD CAPACITY*	STARTER UNITS			ADDER UNITS			EXTRA SHELF LEVEL		
W	D	H		CAT NO.	WT.	PRICE	CAT NO.	WT.	PRICE	CAT NO.	WT.	PRICE
36	18	84	450	ZT7-3618S-5♣	137.0	587.00	ZT7-3618A-5♣	136.0	587.00	ZSSS-3618	17.9	87.00
48	18	84	350	ZT7-4818S-5♣	187.0	749.00	ZT7-4818A-5♣	186.0	749.00	ZSSS-4818	27.0	116.00
36	24	84	450	ZT7-3624S-5♣	160.0	656.00	ZT7-3624A-5♣	159.0	657.00	ZSSS-3624	23.0	106.00
48	24	84	350	ZT7-4824S-5♣	217.0	833.00	ZT7-4824A-5♣	217.0	833.00	ZSSS-4824	33.0	135.00

*Load capacities are per shelf, evenly distributed and based on shelves spaced on 24" centers. Weight not to exceed a total of 1,500 lbs. per unit.

National Motor Freight Class: 70

TIRE RACK



ZST-6084S



ZDT-6084S

NOT FOR USE WITH TIRES MOUNTED ON WHEELS

NOTE: Single Entry units must be tied to wall.

Single Entry units include one 12" deep unit and one 9" wall tie.

Double Entry units include two 12" deep units and one 18" deep cross aisle tie.

UNIT SIZE			# OF OPENINGS	TIRE CAP.	STARTER UNITS			ADDER UNITS		
W	D	H			CAT NO.	WT.	PRICE	CAT NO.	WT.	PRICE
SINGLE ENTRY										
60	21*	60	2	16	ZST-6060S▲	38.0	\$153.00	ZST-6060A▲	34.0	\$136.00
60	21*	84	3	24	ZST-6084S▲	53.0	206.00	ZST-6084A▲	48.0	187.00
60	21*	120	4	32	ZST-60120S▲	74.0	296.00	ZST-60120A▲	67.0	261.00
60	21*	144	5	40	ZST-60144S▲	91.0	355.00	ZST-60144A▲	82.0	321.00
DOUBLE ENTRY										
60	42**	60	4	32	ZDT-6060S▲	80.0	334.00	ZDT-6060A▲	70.0	284.00
60	42**	84	6	48	ZDT-6084S▲	108.0	439.00	ZDT-6084A▲	98.0	389.00
60	42**	120	8	64	ZDT-60120S▲	146.0	578.00	ZDT-60120A▲	133.0	517.00
60	42**	144	10	80	ZDT-60144S▲	178.0	701.00	ZDT-60144A▲	172.0	682.00

*Single Entry units include one 12" deep unit and necessary 9" deep wall tie(s). Quantity depends on height.

**Double Entry units include two 12" deep units and necessary 18" deep cross aisle tie(s). Quantity depends on height.

National Motor Freight Class: 70

Standard Colors



▲ ♣
Items with these symbols are available to ship in 2-3 days. Limited quantities and select colors.

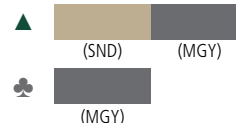

Die Racks & Stur-D-Stor Shelving

HEAVY-DUTY REINFORCED SHELVING (DIE RACK UNIT)



RXHS-602484

Die rack units include 5 shelf levels.

Available in Medium Grey only.



RXHS-962484

UNIT SIZE			SHELF LOAD CAPACITY*	REINFORCEMENTS PER LEVEL	SHELVING UNITS			EXTRA SHELF LEVEL		
W	D	H			CAT NO.	WT.	PRICE	CAT NO.	WT.	PRICE
36	18	72	4,000	1	RXHS-361872	147.0	\$602.00	RXHS-3618	25.0	\$106.00
48	18	72	4,000	1	RXHS-481872	181.0	722.00	RXHS-4818	32.0	127.00
36	18	84	4,000	1	RXHS-361884	151.0	614.00	RXHS-3618	25.0	106.00
48	18	84	4,000	1	RXHS-481884	185.0	734.00	RXHS-4818	32.0	127.00
36	18	96	4,000	1	RXHS-361896	155.0	630.00	RXHS-3618	25.0	106.00
48	18	96	4,000	1	RXHS-481896	189.0	750.00	RXHS-4818	32.0	127.00
36	24	72	4,000	1	RXHS-362472	202.0	677.00	RXHS-3624	32.0	122.00
48	24	72	4,000	1	RXHS-482472	214.0	806.00	RXHS-4824	40.0	148.00
60	24	72	3,250	1	RXHS-602472	255.0	959.00	RXHS-6024	47.0	193.00
72	24	72	2,750	2	RXHS-722472	305.0	1,157.00	RXHS-7224	57.0	224.00
36	24	84	4,000	1	RXHS-362484	206.0	689.00	RXHS-3624	32.0	122.00
48	24	84	4,000	1	RXHS-482484	218.0	818.00	RXHS-4824	40.0	148.00
60	24	84	3,250	1	RXHS-602484	259.0	971.00	RXHS-6024	47.0	193.00
72	24	84	2,750	2	RXHS-722484	309.0	1,169.00	RXHS-7224	57.0	224.00
96	24	84	2,600	3	RXHS-962484	413.0	1,542.00	RXHS-9624	78.0	293.00
36	24	96	4,000	1	RXHS-362496	210.0	705.00	RXHS-3624	32.0	122.00
48	24	96	4,000	1	RXHS-482496	222.0	834.00	RXHS-4824	40.0	148.00
60	24	96	3,250	1	RXHS-602496	263.0	987.00	RXHS-6024	47.0	193.00
72	24	96	2,750	2	RXHS-722496	313.0	1,185.00	RXHS-7224	57.0	224.00
96	24	96	2,600	3	RXHS-962496	417.0	1,558.00	RXHS-9624	78.0	293.00
72	36	84	2,750	2	RXHS-723684	419.0	1,559.00	RXHS-7236	79.0	294.00
96	36	84	2,600	3	RXHS-963684	560.0	1,940.00	RXHS-9636	108.0	373.00
72	36	96	2,750	2	RXHS-723696	424.0	1,575.00	RXHS-7236	79.0	294.00
96	36	96	2,600	3	RXHS-963696	565.0	1,956.00	RXHS-9636	108.0	373.00

*Load capacities are per shelf, evenly distributed. Weight not to exceed a total of 13,000 lbs. per unit and based on shelves spaced on 24" centers. Other heights are available; call factory for pricing.

National Motor Freight Class: 70

STUR-D-STOR SHELVING

CAT. NO.	SHELF LEV. CAP.	NO. OF OPENINGS	W	D	H	WT.	PRICE
SHELVING PACKAGE							
LSS-361872	1,000	4	36 1/2	18 1/2	72	88.0	\$222.00
LSS-482484	850	4	48 1/2	24 1/2	84	142.0	302.00
HARD NYLON PROTECTIVE FOOT CAP							
EURNF	—	—	1 1/2	1 1/2	3/4	0.1	1.00

Includes 1/2" thick particleboard shelves and 8 plastic post caps.
Ships in one pre-packaged box.

Shelving available in Sand only. Protective foot caps are available in Black only.



EURNF

National Motor Freight Class: 70

May be configured as a five-shelf shelving unit or as a work table.



SHELVING

Standard Colors (Unless Otherwise Specified)

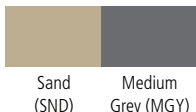

Items with these symbols are available to ship in 2-3 days. Limited quantities and select colors.



Z-Line Components: Posts & Supports

UPRIGHT POSTS



STANDARD ANGLE POST (EUR)

Total weight capacity not to exceed 8,000 lbs. per unit (2,000 lbs. per post), based on 24" shelf centers or less.

INTERMEDIATE "T" POST (ZTP)
Total weight capacity not to exceed 11,000 lbs. per unit (5,500 lbs. per post), based on 24" shelf centers or less.



HIGH CAPACITY ANGLE POST (SUR)

Total weight capacity not to exceed 13,000 lbs. per unit (3,250 lbs. per post), based on 24" shelf centers or less.

All posts slotted for shelf adjustment on 1/2" centers.

National Motor Freight Class: 50

CAT. NO.	W	D	LENGTH	WT.	PRICE
STANDARD ANGLE POST					
EUR-36 ▲	1 15/32	1 15/32	36	2.0	\$7.70
EUR-48 ▲	1 15/32	1 15/32	48	2.7	10.60
EUR-60 ▲	1 15/32	1 15/32	60	3.4	12.20
EUR-72 ▲	1 15/32	1 15/32	72	4.0	14.40
EUR-84 ▲	1 15/32	1 15/32	84	4.7	16.90
EUR-96 ▲	1 15/32	1 15/32	96	5.4	19.50
EUR-108 ▲	1 15/32	1 15/32	108	6.0	22.00
EUR-120 ▲	1 15/32	1 15/32	120	6.7	24.00
EUR-132	1 15/32	1 15/32	132	7.4	27.00
EUR-144 ▲	1 15/32	1 15/32	144	8.1	28.00
INTERMEDIATE "T" POST					
ZTP-36	3 3/8	1 15/32	36	3.9	15.90
ZTP-48 ▲	3 3/8	1 15/32	48	5.1	21.00
ZTP-60 ▲	3 3/8	1 15/32	60	6.4	25.00
ZTP-72 ▲	3 3/8	1 15/32	72	7.7	30.00
ZTP-84 ▲	3 3/8	1 15/32	84	9.0	34.00
ZTP-96 ▲	3 3/8	1 15/32	96	10.3	39.00
ZTP-108 ▲	3 3/8	1 15/32	108	11.6	42.00
ZTP-120 ▲	3 3/8	1 15/32	120	12.8	47.00
ZTP-132	3 3/8	1 15/32	132	14.1	53.00
ZTP-144 ▲	3 3/8	1 15/32	144	15.4	58.00
HIGH CAPACITY ANGLE POST					
SUR-36	2 1/16	2 1/16	36	2.8	10.90
SUR-48	2 1/16	2 1/16	48	3.7	14.60
SUR-60 ▲	2 1/16	2 1/16	60	4.7	17.00
SUR-72 ▲	2 1/16	2 1/16	72	5.4	20.00
SUR-84 ▲	2 1/16	2 1/16	84	6.5	23.00
SUR-96 ▲	2 1/16	2 1/16	96	7.6	27.00
SUR-108	2 1/16	2 1/16	108	8.5	31.00
SUR-120 ▲	2 1/16	2 1/16	120	9.2	33.00
SUR-132	2 1/16	2 1/16	132	10.4	38.00
SUR-144 ▲	2 1/16	2 1/16	144	11.4	40.00
SUR-168	2 1/16	2 1/16	168	13.3	47.00
SUR-181.5	2 1/16	2 1/16	181.5	14.3	51.00

SHELF SUPPORTS

LOW PROFILE SHELF SUPPORTS

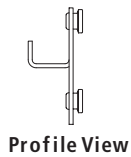

Profile View



Shelf supports are 27/32" d x 1 1/8" h.

National Motor Freight Class: 70

*Load capacities are based on evenly distributed loads.

CAT. NO.	LOAD CAP.*	GA.	LENGTH	WT.	PRICE
LOW PROFILE SHELF SUPPORTS					
DRS-1214 ▲	600	14	11.5	0.5	\$3.40
DRS-1514 ▲	600	14	14.5	0.7	4.00
DRS-1814 ▲	600	14	17.5	0.9	4.50
DRS-2414 ▲	600	14	23.5	1.1	4.50
DRS-3014 ▲	600	14	29.5	1.4	5.50
DRS-3611 ▲	850	11	35.5	2.8	10.60
DRS-3614 ▲	600	14	35.5	1.7	6.40
DRS-4211 ▲	800	11	41.5	3.2	11.20
DRS-4214 ▲	550	14	41.5	2.0	7.20
DRS-4811 ▲	750	11	47.5	3.7	12.00
DRS-4814 ▲	500	14	47.5	2.3	8.00

MEDIUM DUTY SHELF SUPPORTS

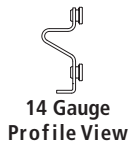

14 Gauge Profile View

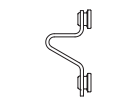

16 Gauge Profile View



Supports slotted for optional FBSV-dd front-to-back deck supports. Load capacities are based on recommended number of deck supports.

National Motor Freight Class: 70

CAT. NO.	LOAD CAP.*	RECOMMENDED # REINFORCEMENTS	GA.	LENGTH	WT.	PRICE
MEDIUM DUTY SHELF SUPPORTS						
VDRS-1216	1,000	—	16	11.5	0.6	3.50
VDRS-1516	1,000	—	16	14.5	0.8	4.20
VDRS-1816 ▲	1,000	—	16	17.5	0.9	4.50
VDRS-2416 ▲	1,000	—	16	23.5	1.3	5.30
VDRS-3016 ▲	1,000	—	16	29.5	1.5	6.60
VDRS-3616 ▲	1,000	1	16	35.5	1.8	7.90
VDRS-4216 ▲	900	1	16	41.5	2.2	9.40
VDRS-4814	1,000	1	14	47.5	3.6	15.70
VDRS-4816 ▲	850	1	16	47.5	2.5	9.90
VDRS-6014 ▲	750	1	14	59.5	4.6	18.10
VDRS-6614	700	1	14	65.5	5.0	19.70
VDRS-6914 ▲	650	2	14	68.5	5.2	20.00
VDRS-7214 ▲	600	2	14	71.5	5.4	22.00

*Load capacities are based on evenly distributed loads.

Standard Colors



▲ Items with this symbol are available to ship in 2-3 days. Limited quantities and select colors.



Z-Line Components: Supports & Reinforcements

SHELF SUPPORTS

CAT. NO.	LOAD CAP.*	RECOMMENDED # REINFORCEMENTS	GA.	LENGTH	WT.	PRICE
HEAVY-DUTY SHELF SUPPORTS (Front-to-Back)						
LRA-12 ▲	—	—	14	11.5	0.9	\$4.60
LRA-15 ▲	—	—	14	14.5	1.2	5.70
LRA-16	—	—	14	15.5	1.3	5.90
LRA-18 ▲	—	—	14	17.5	1.4	5.90
LRA-24 ▲	—	—	14	23.5	1.9	7.30
LRA-30 ▲	—	—	14	29.5	2.3	8.70
LRA-32	—	—	14	31.5	2.5	10.60
LRA-36G	—	—	14	35.5	2.8	10.40
LRA-42G	—	—	14	41.5	3.3	11.60
LRA-48G	—	—	14	47.5	3.7	13.20
HEAVY-DUTY SHELF SUPPORTS (Left-to-Right)						
LRA-36 ▲	2,250	1	14	35.5	2.8	10.60
LRA-42 ▲	2,250	1	14	41.5	3.3	12.50
LRA-48 ▲	2,250	1	14	47.5	3.7	13.60
LRA-60 ▲	2,000	1	14	59.5	4.7	16.80
LRA-69 ▲	1,800	1	14	68.5	5.4	19.20
LRA-72 ▲	1,750	2	14	71.5	5.7	22.00
LRA-84 ▲	1,500	3	14	83.5	6.6	28.00
LRA-96 ▲	1,250	3	14	95.5	7.5	30.00
EXTRA HEAVY-DUTY SHELF SUPPORTS						
LRC-48 ▲	2,500	1	14	47.5	5.2	17.70
LRC-60	2,250	1	14	59.5	6.2	23.00
LRC-72 ▲	2,000	2	14	71.5	7.4	26.00
LRC-84 ▲	1,750	3	14	83.5	8.7	32.00
LRC-96 ▲	1,600	3	14	95.5	9.9	34.00
SEISMIC SHELF SUPPORTS						
SSC-36	2,750	1	14	35.5	4.7	19.70
SSC-48	2,500	1	14	47.5	6.3	25.00
SSC-60	2,250	1	14	59.5	7.9	31.00
SSC-72	2,000	2	14	71.5	9.5	35.00
SSC-84	1,750	3	14	83.5	11.1	41.00
SSC-96	1,600	3	14	95.5	12.7	47.00

*Load capacities are based on evenly distributed loads with the recommended number of SDS-dd front-to-back deck reinforcements.

National Motor Freight Class: 70

HEAVY-DUTY SHELF SUPPORTS

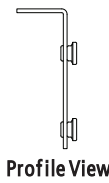

Front-to-back shelf supports are 1" d x 2 3/4" h. Load capacities are based on width of shelf. Front-to-back deck supports do not have center rivets for shelf reinforcements.

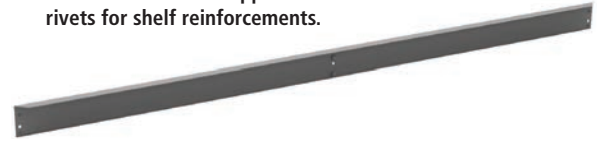
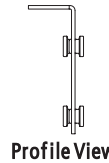

Left-to-right shelf supports are 1" d x 2 3/4" h.

EXTRA HEAVY-DUTY SHELF SUPPORTS

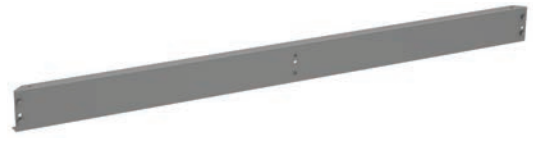
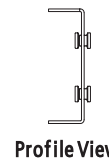

Shelf supports are 1" d x 3 1/4" h.

Use left to right only; not to be used front to back. Cannot be installed in bottom two keyholes of uprights; Will not sit flush on the floor.

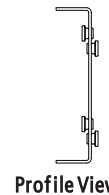

SEISMIC SUPPORT CHANNEL



Shelf supports are 1 1/2" d x 4 13/32" h.

Allows unit to be secured to floor in order to meet seismic requirements.

DECK REINFORCEMENTS

CAT. NO.	W	D	H	WT.	PRICE
MEDIUM DUTY DECK REINFORCEMENTS					
FBSV-12	1 5/8	12	1 5/8	0.6	\$4.50
FBSV-15 ▲	1 5/8	15	1 5/8	0.8	4.60
FBSV-18 ▲	1 5/8	18	1 5/8	0.9	4.60
FBSV-24 ▲	1 5/8	24	1 5/8	1.3	5.90
FBSV-30 ▲	1 5/8	30	1 5/8	1.6	6.60
FBSV-36 ▲	1 5/8	36	1 5/8	1.9	7.70
FBSV-42	1 5/8	42	1 5/8	2.2	11.30
FBSV-48 ▲	1 5/8	48	1 5/8	2.5	12.90
HEAVY DUTY DECK REINFORCEMENTS					
SDS-12 ▲	7/8	12	2 11/16	1.0	3.50
SDS-15 ▲	7/8	15	2 11/16	1.2	4.50
SDS-16	7/8	16	2 11/16	1.3	5.00
SDS-18 ▲	7/8	18	2 11/16	1.4	5.00
SDS-24 ▲	7/8	24	2 11/16	1.9	6.10
SDS-30 ▲	7/8	30	2 11/16	2.4	7.70
SDS-32	7/8	32	2 11/16	2.5	8.60
SDS-36 ▲	7/8	36	2 11/16	2.8	8.60
SDS-42	7/8	42	2 11/16	3.3	11.30
SDS-48 ▲	7/8	48	2 11/16	3.8	11.40

National Motor Freight Class: 70

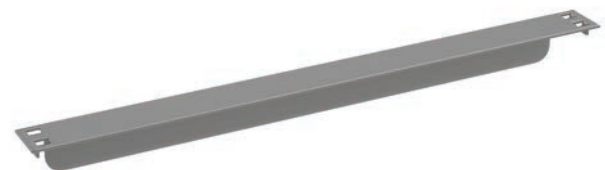

Medium duty provides center reinforcement for decking. Use with VDRS supports.



Heavy duty provides center reinforcement for decking. Use with LRA, LRC or SSC supports.

Standard Colors



▲ Items with these symbols are available to ship in 2-3 days. Limited quantities and select colors.



Z-Line Components: Decking Options

PARTICLEBOARD DECKING



Industrial grade 5/8" thick particleboard provides a sturdy work surface that is both strong and economical.

CAT. NO.	W	D	H	WT.	PRICE
PB-3612	36	12	5/8	7.5	\$6.90
PB-3615	36	15	5/8	9.4	7.60
PB-3618	36	18	5/8	11.3	9.90
PB-3624	36	24	5/8	15.0	13.90
PB-3630	36	30	5/8	18.8	16.50
PB-3636	36	36	5/8	22.5	19.60
PB-4212	42	12	5/8	8.8	8.80
PB-4215	42	15	5/8	10.9	9.40
PB-4218	42	18	5/8	13.1	12.50
PB-4224	42	24	5/8	17.5	16.40
PB-4230	42	30	5/8	21.9	18.10
PB-4236	42	36	5/8	26.3	23.00
PB-4812	48	12	5/8	10.0	9.30
PB-4815	48	15	5/8	12.5	11.60
PB-4818	48	18	5/8	15.0	13.10
PB-4824	48	24	5/8	20.0	16.70
PB-4830	48	30	5/8	25.0	21.00
PB-4836	48	36	5/8	31.0	25.00
PB-4842	48	42	5/8	35.0	39.00
PB-4848	48	48	5/8	40.0	35.00
PB-6024	60	24	5/8	25.0	22.00
PB-6030	60	30	5/8	31.3	28.00
PB-6036	60	36	5/8	37.5	34.00
PB-6048	60	48	5/8	50.0	41.00
PB-6915	69	15	5/8	18.0	16.20
PB-6930	69	30	5/8	35.9	36.00
PB-7224	72	24	5/8	30.0	29.00
PB-7230	72	30	5/8	37.5	33.00
PB-7236	72	36	5/8	45.0	39.00
PB-7248	72	48	5/8	60.0	51.00
PB-8424	84	24	5/8	35.0	35.00
PB-8430	84	30	5/8	50.0	42.00
PB-8436	84	36	5/8	52.5	52.00
PB-8448	84	48	5/8	70.0	69.00
PB-9624	96	24	5/8	44.0	35.00
PB-9630	96	30	5/8	50.0	42.00
PB-9636	96	36	5/8	60.0	52.00
PB-9648	96	48	5/8	80.0	69.00

Available in Natural only.
National Motor Freight Class: 55

STEEL SHELVES

Attaches to upright posts with four shelf clips per shelf (included). Shelf clips allow for access from all four sides of the unit.

NOTE: When building your own unit with steel shelves, you MUST use VDRS supports at the top and bottom of the unit, on all four sides for stabilization. Shelf clips alone are NOT sufficient to stabilize unit.

In addition, units 96" and taller must use VDRS supports in the center of the unit, on all four sides.

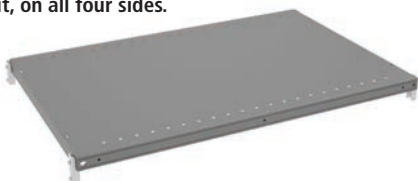

Shelf Clip

Standard Colors (Unless Otherwise Specified)



Items with these symbols are available to ship in 2-3 days. Limited quantities and select colors.



WIRE DECKING

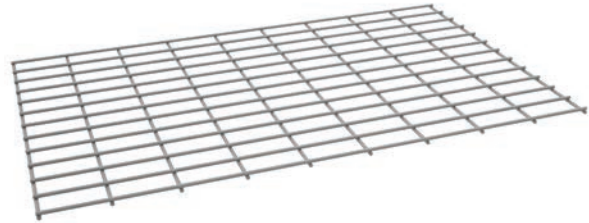

Wire decking uses 5 gauge wire & consists of a 2" x 4" mesh pattern. Additional sizes are available; contact factory for pricing.

Wire decking is subject to longer than normal lead times; contact factory for specifics.

Not recommended for shelf levels with DRS supports deeper than 24".

CAT. NO.	W	D	H	WT.	PRICE
ZWD-3612	36	12	5/16	4.0	\$30.00
ZWD-3618	36	18	5/16	6.0	37.00
ZWD-3624	36	24	5/16	8.0	45.00
ZWD-3636	36	36	5/16	12.0	61.00
ZWD-4218	42	18	5/16	7.1	53.00
ZWD-4224	42	24	5/16	9.3	57.00
ZWD-4230	42	30	5/16	11.7	67.00
ZWD-4236	42	36	5/16	14.2	67.00
ZWD-4812	48	12	5/16	5.4	32.00
ZWD-4815	48	15	5/16	7.0	50.00
ZWD-4818	48	18	5/16	8.0	41.00
ZWD-4824	48	24	5/16	10.7	54.00
ZWD-4836	48	36	5/16	16.0	72.00
ZWD-4848	48	48	5/16	21.0	100.00
ZWD-6030	60	30	5/16	13.3	103.00
ZWD-6036	60	36	5/16	20.0	103.00
ZWD-6048	60	48	5/16	27.0	143.00
ZWD-6930	69	30	5/16	19.2	92.00
ZWD-7224	72	24	5/16	16.0	83.00
ZWD-7236	72	36	5/16	24.0	109.00
ZWD-7248	72	48	5/16	32.0	127.00
ZWD-8424*	84	24	5/16	19.0	100.00
ZWD-8436*	84	36	5/16	28.0	125.00
ZWD-8448*	84	48	5/16	37.0	172.00
ZWD-9624*	96	24	5/16	21.0	106.00
ZWD-9636*	96	36	5/16	32.0	144.00
ZWD-9648*	96	48	5/16	42.0	200.00

*84" w and 96" w are shipped as two pieces and should be tied together with zip ties.

NOTE: Price shown is for Medium Grey. For price of Sand or Light Grey, add a 10% upcharge.

National Motor Freight Class: 70

CAT. NO.	Load Cap.	W	D	H	WT.	PRICE
22 Gauge						
ZMS-3612	750	36	12	1 5/16	6.7	\$28.00
ZMS-3618	750	36	18	1 5/16	8.8	35.00
ZMS-3624	700	36	24	1 5/16	10.9	42.00
ZMS-4212	600	42	12	1 5/16	7.7	36.00
ZMS-4218	600	42	18	1 5/16	10.1	42.00
ZMS-4224	550	42	24	1 5/16	12.5	50.00
ZMS-4812	500	48	12	1 5/16	8.7	35.00
ZMS-4818	500	48	18	1 5/16	11.4	44.00
ZMS-4824	450	48	24	1 5/16	14.1	53.00
20 Gauge						
ZMS-3636	600	36	36	1 5/16	17.9	74.00
ZMS-4236	550	42	36	1 5/16	21.0	80.00
ZMS-4836	450	48	36	1 5/16	23.0	88.00
REPLACEMENT SHELF CLIPS						
ZSC-1	—	—	—	—	0.1	1.10

National Motor Freight Class: 70

Z-Line Components: Accessories

SIDE AND BACK PANELS

CAT. NO.	W	D	H	WT.	PRICE
SIDE PANELS					
ZLEP-1284	—	12	84	11.5	\$77.00
ZLEP-1584	—	15	84	14.0	\$81.00
ZLEP-1884	—	18	84	16.6	\$89.00
ZLEP-2484	—	24	84	22.0	\$103.00
ZLEP-3084	—	30	84	27.0	\$118.00
BACK PANELS					
ZLBP-3684	36	—	84	35.0	\$162.00
ZLBP-4284	42	—	84	42.0	\$165.00
ZLBP-4884	48	—	84	48.0	\$180.00
CLIPS FOR PANELS					
Z-CLIP	—	—	—	0.1	1.50

National Motor Freight Class: 70



BACK PANEL

Back panels fit units with EUR and ZTP posts. Back consists of two pieces. Includes 10 attachment clips. Other sizes available; contact factory.



SIDE PANEL

Side panels fit starter units with EUR posts only. Side consists of two pieces. Includes 10 attachment clips. Other sizes available; contact factory.

CAT. NO.	W	D	H	WT.	PRICE
DIV2410	—	24	10	4.4	\$21.00

Use on particleboard, front-to-back, to subdivide shelf into several storage areas.

National Motor Freight Class: 70

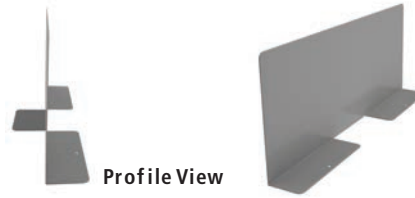

Profile View

SHELF DIVIDER

CAT. NO.	CASTERS	W	D	H	WT.	PRICE
ZLCK-1	2 Fixed, 2 Swivel	1 1/2	1 1/2	7/16	12.8	\$170.00
ZLCK-2	4 Swivel	3 7/16	2	7/16	13.0	\$173.00

National Motor Freight Class: 70

Load capacity for caster kit is 1,000 lbs. Casters should not be used with units over 96" tall, or on units less than 18" deep. Maximum unit size is 60" wide by 30" deep.

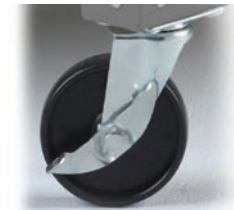

CASTER KITS

CAT. NO.	LOAD CAP.	W	D	H	WT.	PRICE
FOR LRA OR LRC SUPPORTS						
Channel-Shaped Hang Rods						
PHR-36♣	150	36 1/4	1 5/16	1 1/16	2.9	\$10.30
PHR-48♣	150	48 1/4	1 5/16	1 1/16	3.8	\$13.10

National Motor Freight Class: 70

Used for hanging items left-to-right on a Z-Line unit. Attaches between two LRA shelf supports.

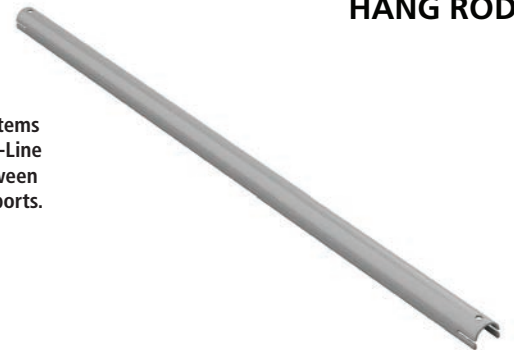

HANG RODS

CAT. NO.	Use With	W	D	H	WT.	PRICE
SOFT TOP EDGE CAPS						
EURPC●	EUR Uprights	1 1/2	1 1/2	7/16	0.1	\$1.10
ZTPPC●	ZTP Uprights	3 7/16	2	7/16	0.1	1.70
SURPC●	SUR Uprights	2 3/4	2 3/4	7/16	0.1	.86
HARD NYLON FOOT CAPS						
EURNF●	EUR Uprights	1 1/2	1 1/2	3/4	0.1	1.00
ZTPNF●	ZTP Uprights	3 7/16	2	3/4	0.2	1.70
SURNF●	SUR Uprights	2 3/4	2 3/4	3/4	0.2	1.40

Available in Black only.
National Motor Freight Class: 70

Place top edge caps over top of uprights to protect from sharp edges. Place foot caps beneath uprights as a floor protector.



Hard Nylon Foot Caps

Soft Top Edge Caps

Standard Colors (Unless Otherwise Specified)



♣ ●
Items with these symbols are available to ship in 2-3 days. Limited quantities and select colors.

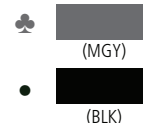

Z-Line Components: Accessories

CROSS AISLE TIES

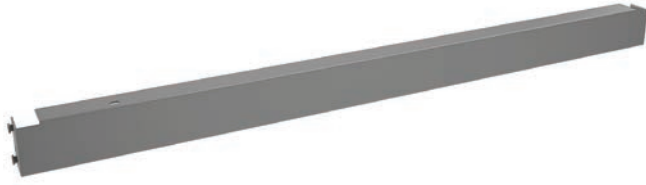

CAT. NO.	W	D	H	WT.	PRICE
CAT-18♣	1 3/8	18	2 3/8	1.4	\$11.80
CAT-24	1 3/8	24	2 3/8	1.9	13.00
CAT-30	1 3/8	30	2 3/8	2.4	15.70
CAT-36♣	1 3/8	36	2 3/8	2.8	16.80
CAT-42	1 3/8	42	2 3/8	3.3	18.50
CAT-48	1 3/8	48	2 3/8	3.8	24.00

Used to link across an aisle for extra stability.
National Motor Freight Class: 70

ADJUSTABLE AISLE TIE



CAT. NO.	W	D	H	WT.	PRICE
KCAT-1	3	*	1	6.0	\$34.00

*Depth adjusts from 36" to 60"

Links units across an aisle at adjustable distances.
National Motor Freight Class: 70

POST SPLICE ANGLE

Includes hardware. Used for splicing EUR, SUR and ZTP upright posts. When splicing ZTP uprights, two post splice angles are required per post.



CAT. NO.	W	D	H	WT.	PRICE
PSA-2	1 9/16	1 9/16	6 1/2	1.1	\$8.60

National Motor Freight Class: 70

WALL TIE



Used to secure a unit to a wall, with a 9" gap between the unit and the wall.

CAT. NO.	W	D	H	WT.	PRICE
WT-9♣	9 1/4	1 3/8	2 3/8	.7	\$4.80

National Motor Freight Class: 70

TIE PLATE



Used to secure two angle posts together front-to-back or side-by-side.

CAT. NO.	W	D	H	WT.	PRICE
TP-1▲	3	—	2 3/4	.2	\$1.90

National Motor Freight Class: 70

ANCHOR PLATE



Attaches to uprights to allow anchoring uprights to the floor.

CAT. NO.	W	D	H	WT.	PRICE
ZFA-1▲	1 3/8	1 1/2	2 3/8	.2	\$3.50

National Motor Freight Class: 70

FOOT PLATES

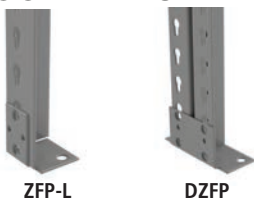

Attaches to uprights to allow anchoring uprights to the floor.

CAT. NO.	W	D	H	WT.	PRICE
FOOT PLATE FOR LEFT UPRIGHT (EUR or SUR)					
ZFP-L♣	1 3/8	1 1/2	2 3/8	.2	\$2.00
FOOT PLATE FOR RIGHT UPRIGHT (EUR or SUR)					
ZFP-R♣	1 3/8	1 1/2	2 3/8	.2	2.00
FOOT PLATE FOR ZTP UPRIGHTS					
DZFP♣	2 3/4	1 1/2	2 3/8	.5	5.00

National Motor Freight Class: 70

Standard Colors



♣ ▲
Items with these symbols are available to ship in 2-3 days. Limited quantities and select colors.

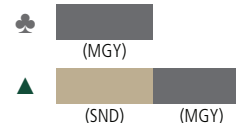

Automotive Shelving

PRE-CONFIGURED SHELVING UNITS

CAT. NO.	# SHELVES	W	D	H	WT.	PRICE
P-8401	6	38	12	84	114.0	\$396.00
P-8411	12	38	12	84	150.0	508.00

Units include back but no end panels. Order end panels separately to provide flush finished ends for row. Dimensions shown are outside dimensions.

Assembly Required.

National Motor Freight Class: 70



P-8401



P-8411

UPRIGHTS (Sold As Pairs)



CAT. NO.	W	D	H	WT.	PRICE
P-1284	15 ¹ / ₁₆	12	84	31.8	\$116.00
P-1296	15 ¹ / ₁₆	12	96	36.0	139.00

National Motor Freight Class: 70

End Panels (Sold As Pairs)



P-84E

CAT. NO.	W	D	H	WT.	PRICE
P-84E	1 ¹ / ₁₆	12 ³ / ₃₂	84	22.0	\$73.00
P-96E	1 ¹ / ₁₆	12 ³ / ₃₂	96	25.0	87.00

National Motor Freight Class: 70

BACKS



CAT. NO.	W	D	H	WT.	PRICE
P-3884	37 ³ / ₄	12	84	32.9	\$109.00
P-3896	37 ³ / ₄	12	96	37.6	129.00

National Motor Freight Class: 70

When placing units back to back (as in double-face application), units may share a common back.

BIN BOXES



P-55



P-55D

CAT. NO.	W	D	H	WT.	PRICE
Bin Box					
P-55	5 ¹ / ₂	12	3 ¹ / ₄	2.0	\$27.00
Bin Box Divider					
P-55D	5 ³ / ₁₆	1 ¹ / ₃₂	2 ⁵ / ₁₆	0.1	1.50

Each shelf can hold up to 6 bin boxes.

National Motor Freight Class: 70

LABEL HOLDERS



P-38F

CAT. NO.	W	D	H	WT.	PRICE
Full Shelf-Width					
P-38	35 ¹ / ₄	11 ¹ / ₆₄	7 ⁷ / ₈	0.3	2.80
Fastener For Full Shelf-Width Holders					
P-38F	—	—	—	0.1	.13

National Motor Freight Class: 70



P-38

SLIDING DIVIDERS



P-45

CAT. NO.	W	D	H	WT.	PRICE
P-30	3	12	3	0.7	\$8.20
P-45	3	12	4 ¹ / ₂	0.9	8.70
P-60	3	12	6	1.0	9.00

National Motor Freight Class: 70

CAT. NO.	W	D	H	WT.	PRICE
Top					
P-1238	37 ⁷ / ₈	12 ¹ / ₈	1 ¹ / ₈	6.3	\$29.00
Bottom					
P-12B	36	11 ⁷ / ₈	3 ¹ / ₁₆	7.0	30.00
Shelf					
P-12	35 ⁷ / ₈	11 ⁷ / ₈	7 ⁷ / ₈	6.0	18.70

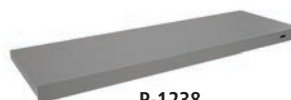

P-1238

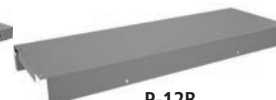

P-12B

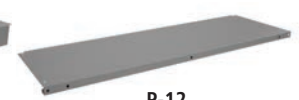

P-12

National Motor Freight Class: 70

Standard Colors (Unless Otherwise Specified)



Sand (SND) Light Grey (LGY) Medium Grey (MGY)

Bulk Storage Racks

BULK STORAGE RACKS - 24" DEEP

*Load capacities are based on evenly distributed loads.



STARTER



ADDER

**Wire Decking available in Medium Grey only.

National Motor Freight Class: 70

Units are intended to be hand loaded only.

UNIT SIZE			SHELF LOAD CAPACITY*	REINFORCEMENTS PER LEVEL	STARTER UNITS			ADDER UNITS			EXTRA SHELF LEVEL		
W	D	H			CAT NO.	WT.	PRICE	CAT NO.	WT.	PRICE	CAT NO.	WT.	PRICE
Particleboard Decking													
48	24	72	4,150	2	BU-482472PS♣	154	\$402.00	BU-482472PA♣	134	\$322.00	BU-4824P♣	38.0	\$81.00
72	24	72	2,750	3	BU-722472PS♣	205	511.00	BU-722472PA♣	185	431.00	BU-7224P♣	55.0	117.00
96	24	72	2,150	4	BU-962472PS♣	262	604.00	BU-962472PA♣	242	524.00	BU-9624P♣	74.0	148.00
48	24	84	4,150	2	BU-482484PS♣	162	468.00	BU-482484PA♣	138	355.00	BU-4824P♣	38.0	81.00
72	24	84	2,750	3	BU-722484PS♣	213	578.00	BU-722484PA♣	189	466.00	BU-7224P♣	55.0	117.00
96	24	84	2,150	4	BU-962484PS♣	270	672.00	BU-962484PA♣	246	560.00	BU-9624P♣	74.0	148.00
48	24	96	4,150	2	BU-482496PS♣	170	454.00	BU-482496PA♣	142	348.00	BU-4824P♣	38.0	81.00
72	24	96	2,750	3	BU-722496PS♣	221	563.00	BU-722496PA♣	193	457.00	BU-7224P♣	55.0	117.00
96	24	96	2,150	4	BU-962496PS♣	278	656.00	BU-962496PA♣	250	550.00	BU-9624P♣	74.0	148.00
48	24	120	4,150	2	BU-4824120PS♣	180	502.00	BU-4824120PA♣	147	372.00	BU-4824P♣	38.0	81.00
72	24	120	2,750	3	BU-7224120PS♣	231	611.00	BU-7224120PA♣	198	481.00	BU-7224P♣	55.0	117.00
96	24	120	2,150	4	BU-9624120PS♣	288	704.00	BU-9624120PA♣	255	574.00	BU-9624P♣	74.0	148.00
Corrugated Decking													
48	24	72	4,150	2	BU-482472CS♣	136	511.00	BU-482472CA♣	116	431.00	BU-4824C♣	32.0	117.00
72	24	72	2,750	3	BU-722472CS♣	178	652.00	BU-722472CA♣	158	572.00	BU-7224C♣	46.0	164.00
96	24	72	2,150	4	BU-962472CS♣	226	793.00	BU-962472CA♣	206	713.00	BU-9624C♣	62.0	211.00
48	24	84	4,150	2	BU-482484CS♣	144	581.00	BU-482484CA♣	120	467.00	BU-4824C♣	32.0	117.00
72	24	84	2,750	3	BU-722484CS♣	186	718.00	BU-722484CA♣	162	605.00	BU-7224C♣	46.0	164.00
96	24	84	2,150	4	BU-962484CS♣	234	859.00	BU-962484CA♣	210	746.00	BU-9624C♣	62.0	211.00
48	24	96	4,150	2	BU-482496CS♣	152	563.00	BU-482496CA♣	124	457.00	BU-4824C♣	32.0	117.00
72	24	96	2,750	3	BU-722496CS♣	194	704.00	BU-722496CA♣	166	598.00	BU-7224C♣	46.0	164.00
96	24	96	2,150	4	BU-962496CS♣	242	845.00	BU-962496CA♣	214	739.00	BU-9624C♣	62.0	211.00
48	24	120	4,150	2	BU-4824120CS♣	162	611.00	BU-4824120CA♣	129	481.00	BU-4824C♣	32.0	117.00
72	24	120	2,750	3	BU-7224120CS♣	204	752.00	BU-7224120CA♣	171	622.00	BU-7224C♣	46.0	164.00
96	24	120	2,150	4	BU-9624120CS♣	252	893.00	BU-9624120CA♣	219	763.00	BU-9624C♣	62.0	211.00
Wire Decking**													
48	24	72	4,150	2	BU-482472WS♣	126	514.00	BU-482472WA♣	106	434.00	BU-4824W♣	29.0	118.00
72	24	72	2,750	3	BU-722472WS♣	163	673.00	BU-722472WA♣	143	593.00	BU-7224W♣	41.0	171.00
96	24	72	2,150	4	BU-962472WS♣	206	823.00	BU-962472WA♣	186	743.00	BU-9624W♣	55.0	221.00
48	24	84	4,150	2	BU-482484WS♣	134	584.00	BU-482484WA♣	110	460.00	BU-4824W♣	29.0	118.00
72	24	84	2,750	3	BU-722484WS♣	171	740.00	BU-722484WA♣	147	627.00	BU-7224W♣	41.0	171.00
96	24	84	2,150	4	BU-962484WS♣	213	875.00	BU-962484WA♣	189	769.00	BU-9624W♣	55.0	221.00
48	24	96	4,150	2	BU-482496WS♣	142	566.00	BU-482496WA♣	114	460.00	BU-4824W♣	29.0	118.00
72	24	96	2,750	3	BU-722496WS♣	179	725.00	BU-722496WA♣	151	619.00	BU-7224W♣	41.0	171.00
96	24	96	2,150	4	BU-962496WS♣	222	875.00	BU-962496WA♣	194	769.00	BU-9624W♣	55.0	221.00
48	24	120	4,150	2	BU-4824120WS♣	152	614.00	BU-4824120WA♣	119	484.00	BU-4824W♣	29.0	118.00
72	24	120	2,750	3	BU-7224120WS♣	189	773.00	BU-7224120WA♣	156	643.00	BU-7224W♣	41.0	171.00
96	24	120	2,150	4	BU-9624120WS♣	232	923.00	BU-9624120WA♣	199	793.00	BU-9624W♣	55.0	221.00
No Decking													
48	24	72	4,150	2	BU-482472S♣	94	355.00	BU-482472A♣	74	275.00	BU-4824♣	18.1	65.00
72	24	72	2,750	3	BU-722472S♣	115	426.00	BU-722472A♣	95	346.00	BU-7224♣	25.0	89.00
96	24	72	2,150	4	BU-962472S♣	125	432.00	BU-962472A♣	122	420.00	BU-9624♣	34.0	113.00
48	24	84	4,150	2	BU-482484S♣	102	421.00	BU-482484A♣	78	308.00	BU-4824♣	18.1	65.00
72	24	84	2,750	3	BU-722484S♣	123	492.00	BU-722484A♣	99	379.00	BU-7224♣	25.0	89.00
96	24	84	2,150	4	BU-962484S♣	150	566.00	BU-962484A♣	126	453.00	BU-9624♣	34.0	113.00
48	24	96	4,150	2	BU-482496S♣	110	407.00	BU-482496A♣	82	301.00	BU-4824♣	18.1	65.00
72	24	96	2,750	3	BU-722496S♣	131	478.00	BU-722496A♣	103	372.00	BU-7224♣	25.0	89.00
96	24	96	2,150	4	BU-962496S♣	158	552.00	BU-962496A♣	130	446.00	BU-9624♣	34.0	113.00
48	24	120	4,150	2	BU-4824120S♣	120	454.00	BU-4824120A♣	87	325.00	BU-4824♣	18.1	65.00
72	24	120	2,750	3	BU-7224120S♣	141	525.00	BU-7224120A♣	108	395.00	BU-7224♣	25.0	89.00
96	24	120	2,150	4	BU-9624120S♣	168	599.00	BU-9624120A♣	135	470.00	BU-9624♣	34.0	113.00

Standard Colors (Unless Otherwise Specified)



Items with this symbol are available to ship in 2-3 days. Limited quantities and select colors.



(MGY)

Bulk Storage Racks

*Load capacities are based on evenly distributed loads.

BULK STORAGE RACKS - 36" DEEP

To reach 4,150 lbs. shelf level capacity on 48" wide units, two additional BPS are required. Must be purchased separately.



STARTER



ADDER

**Wire Decking available in Medium Grey only.

National Motor Freight Class: 70

Units are intended to be hand loaded only.

UNIT SIZE			SHELF LOAD CAPACITY*	REINFORCEMENTS PER LEVEL	STARTER UNITS			ADDER UNITS			EXTRA SHELF LEVEL		
W	D	H			CAT NO.	WT.	PRICE	CAT NO.	WT.	PRICE	CAT NO.	WT.	PRICE
Particleboard Decking													
48	36	72	3,000	2	BU-483672PS♣	193	\$453.00	BU-483672PA♣	171	\$366.00	BU-4836P♣	50.0	\$93.00
72	36	72	2,750	3	BU-723672PS♣	260	570.00	BU-723672PA♣	238	483.00	BU-7236P♣	72.0	132.00
96	36	72	2,150	4	BU-963672PS♣	335	690.00	BU-963672PA♣	313	603.00	BU-9636P♣	97.0	172.00
48	36	84	3,000	2	BU-483684PS♣	198	518.00	BU-483684PA♣	173	400.00	BU-4836P♣	50.0	93.00
72	36	84	2,750	3	BU-723684PS♣	266	638.00	BU-723684PA♣	241	521.00	BU-7236P♣	72.0	132.00
96	36	84	2,150	4	BU-963684PS♣	341	756.00	BU-963684PA♣	316	638.00	BU-9636P♣	97.0	172.00
48	36	96	3,000	2	BU-483696PS♣	209	517.00	BU-483696PA♣	179	398.00	BU-4836P♣	50.0	93.00
72	36	96	2,750	3	BU-723696PS♣	276	634.00	BU-723696PA♣	246	515.00	BU-7236P♣	72.0	132.00
96	36	96	2,150	4	BU-963696PS♣	351	754.00	BU-963696PA♣	321	635.00	BU-9636P♣	97.0	172.00
48	36	120	3,000	2	BU-4836120PS♣	221	559.00	BU-4836120PA♣	185	419.00	BU-4836P♣	50.0	93.00
72	36	120	2,750	3	BU-7236120PS♣	288	676.00	BU-7236120PA♣	252	536.00	BU-7236P♣	72.0	132.00
96	36	120	2,150	4	BU-9636120PS♣	363	796.00	BU-9636120PA♣	327	675.00	BU-9636P♣	97.0	172.00
Corrugated Decking													
48	36	72	3,000	2	BU-483672CS♣	163	609.00	BU-483672CA♣	141	522.00	BU-4836C♣	40.0	145.00
72	36	72	2,750	3	BU-723672CS♣	218	783.00	BU-723672CA♣	196	696.00	BU-7236C♣	58.0	203.00
96	36	72	2,150	4	BU-963672CS♣	275	963.00	BU-963672CA♣	253	876.00	BU-9636C♣	77.0	263.00
48	36	84	3,000	2	BU-483684CS♣	168	676.00	BU-483684CA♣	143	556.00	BU-4836C♣	40.0	145.00
72	36	84	2,750	3	BU-723684CS♣	224	849.00	BU-723684CA♣	199	729.00	BU-7236C♣	58.0	203.00
96	36	84	2,150	4	BU-963684CS♣	281	1,029.00	BU-963684CA♣	256	909.00	BU-9636C♣	77.0	263.00
48	36	96	3,000	2	BU-483696CS♣	179	673.00	BU-483696CA♣	149	554.00	BU-4836C♣	40.0	145.00
72	36	96	2,750	3	BU-723696CS♣	234	847.00	BU-723696CA♣	204	728.00	BU-7236C♣	58.0	203.00
96	36	96	2,150	4	BU-963696CS♣	291	1,027.00	BU-963696CA♣	261	908.00	BU-9636C♣	77.0	263.00
48	36	120	3,000	2	BU-4836120CS♣	191	715.00	BU-4836120CA♣	155	575.00	BU-4836C♣	40.0	145.00
72	36	120	2,750	3	BU-7236120CS♣	246	889.00	BU-7236120CA♣	210	749.00	BU-7236C♣	58.0	203.00
96	36	120	2,150	4	BU-9636120CS♣	303	1,069.00	BU-9636120CA♣	267	929.00	BU-9636C♣	77.0	263.00
Wire Decking**													
48	36	72	3,000	2	BU-483672WS♣	148	594.00	BU-483672WA♣	126	507.00	BU-4836W♣	35.0	140.00
72	36	72	2,750	3	BU-723672WS♣	197	780.00	BU-723672WA♣	175	693.00	BU-7236W♣	51.0	202.00
96	36	72	2,150	4	BU-963672WS♣	251	966.00	BU-963672WA♣	229	879.00	BU-9636W♣	69.0	264.00
48	36	84	3,000	2	BU-483684WS♣	153	662.00	BU-483684WA♣	128	542.00	BU-4836W♣	35.0	140.00
72	36	84	2,750	3	BU-723684WS♣	203	850.00	BU-723684WA♣	178	729.00	BU-7236W♣	51.0	202.00
96	36	84	2,150	4	BU-963684WS♣	257	1,034.00	BU-963684WA♣	232	913.00	BU-9636W♣	69.0	264.00
48	36	96	3,000	2	BU-483696WS♣	164	658.00	BU-483696WA♣	134	539.00	BU-4836W♣	35.0	140.00
72	36	96	2,750	3	BU-723696WS♣	213	844.00	BU-723696WA♣	183	725.00	BU-7236W♣	51.0	202.00
96	36	96	2,150	4	BU-963696WS♣	267	1,030.00	BU-963696WA♣	237	911.00	BU-9636W♣	69.0	264.00
48	36	120	3,000	2	BU-4836120WS♣	176	700.00	BU-4836120WA♣	140	560.00	BU-4836W♣	35.0	140.00
72	36	120	2,750	3	BU-7236120WS♣	225	886.00	BU-7236120WA♣	189	746.00	BU-7236W♣	51.0	202.00
96	36	120	2,150	4	BU-9636120WS♣	279	1,072.00	BU-9636120WA♣	243	932.00	BU-9636W♣	69.0	264.00
No Decking													
48	36	72	3,000	2	BU-483672S♣	99	380.00	BU-483672A♣	77	293.00	BU-4836♣	18.5	68.00
72	36	72	2,750	3	BU-723672S♣	125	458.00	BU-723672A♣	103	371.00	BU-7364♣	27.0	94.00
96	36	72	2,150	4	BU-963672S♣	155	536.00	BU-963672A♣	133	448.00	BU-9636♣	37.0	120.00
48	36	84	3,000	2	BU-483684S♣	105	446.00	BU-483684A♣	81	326.00	BU-4836♣	18.5	68.00
72	36	84	2,750	3	BU-723684S♣	131	524.00	BU-723684A♣	106	404.00	BU-7236♣	27.0	94.00
96	36	84	2,150	4	BU-963684S♣	161	602.00	BU-963684A♣	136	481.00	BU-9636♣	37.0	120.00
48	36	96	3,000	2	BU-483696S♣	115	444.00	BU-483696A♣	85	325.00	BU-4836♣	18.5	68.00
72	36	96	2,750	3	BU-723696S♣	141	522.00	BU-723696A♣	111	402.00	BU-7236♣	27.0	94.00
96	36	96	2,150	4	BU-963696S♣	171	599.00	BU-963696A♣	141	480.00	BU-9636♣	37.0	120.00
48	36	120	3,000	2	BU-4836120S♣	127	486.00	BU-4836120A♣	91	346.00	BU-4836♣	18.5	68.00
72	36	120	2,750	3	BU-7236120S♣	153	564.00	BU-7236120A♣	117	424.00	BU-7236♣	27.0	94.00
96	36	120	2,150	4	BU-9636120S♣	183	642.00	BU-9636120A♣	147	502.00	BU-9636♣	37.0	120.00

Standard Colors (Unless Otherwise Specified)



♣ Items with these symbols are available to ship in 2-3 days. Limited quantities and select colors.

Bulk Storage Racks

BULK STORAGE RACKS - 48" DEEP

*Load capacities are based on evenly distributed loads.

To reach 4,150 lbs. shelf level capacity on 48" wide units, six additional BPS are required. Must be purchased separately.



STARTER



ADDER

**Wire Decking available in Medium Grey only.

National Motor Freight Class: 70

Units are intended to be hand loaded only.

UNIT SIZE			SHELF LOAD CAPACITY*	REINFORCEMENTS PER LEVEL	STARTER UNITS			ADDER UNITS			EXTRA SHELF LEVEL		
W	D	H			CAT NO.	WT.	PRICE	CAT NO.	WT.	PRICE	CAT NO.	WT.	PRICE
Particleboard Decking													
48	48	72	1,500	2	BU-484872PS♣	229	\$516.00	BU-484872PA♣	206	\$420.00	BU-4848P♣	61.0	\$108.00
72	48	72	2,750	3	BU-724872PS♣	319	645.00	BU-724872PA♣	296	549.00	BU-7248P♣	91.0	151.00
96	48	72	2,150	4	BU-964872PS♣	397	786.00	BU-964872PA♣	374	690.00	BU-9648P♣	117.0	198.00
48	48	84	1,500	2	BU-484884PS♣	237	592.00	BU-484884PA♣	210	460.00	BU-4848P♣	61.0	108.00
72	48	84	2,750	3	BU-724884PS♣	327	727.00	BU-724884PA♣	300	595.00	BU-7248P♣	91.0	151.00
96	48	84	2,150	4	BU-964884PS♣	405	868.00	BU-964884PA♣	378	736.00	BU-9648P♣	117.0	198.00
48	48	96	1,500	2	BU-484896PS♣	249	588.00	BU-484896PA♣	216	456.00	BU-4848P♣	61.0	108.00
72	48	96	2,750	3	BU-724896PS♣	339	717.00	BU-724896PA♣	306	585.00	BU-7248P♣	91.0	151.00
96	48	96	2,150	4	BU-964896PS♣	417	858.00	BU-964896PA♣	384	726.00	BU-9648P♣	117.0	198.00
48	48	120	1,500	2	BU-4848120PS♣	259	628.00	BU-4848120PA♣	221	489.00	BU-4848P♣	61.0	108.00
72	48	120	2,750	3	BU-7248120PS♣	349	757.00	BU-7248120PA♣	311	627.00	BU-7248P♣	91.0	151.00
96	48	120	2,150	4	BU-9648120PS♣	427	898.00	BU-9648120PA♣	389	772.00	BU-9648P♣	117.0	198.00
Corrugated Decking													
48	48	72	1,500	2	BU-484872CS♣	193	708.00	BU-484872CA♣	170	612.00	BU-4848C♣	49.0	172.00
72	48	72	2,750	3	BU-724872CS♣	265	921.00	BU-724872CA♣	242	825.00	BU-7248C♣	73.0	243.00
96	48	72	2,150	4	BU-964872CS♣	331	1,137.00	BU-964872CA♣	308	1,041.00	BU-9648C♣	95.0	315.00
48	48	84	1,500	2	BU-484884CS♣	201	788.00	BU-484884CA♣	174	653.00	BU-4848C♣	49.0	172.00
72	48	84	2,750	3	BU-724884CS♣	246	1,004.00	BU-724884CA♣	273	868.00	BU-7248C♣	73.0	243.00
96	48	84	2,150	4	BU-964884CS♣	339	1,220.00	BU-964884CA♣	312	1,084.00	BU-9648C♣	95.0	315.00
48	48	96	1,500	2	BU-484896CS♣	213	780.00	BU-484896CA♣	180	648.00	BU-4848C♣	49.0	172.00
72	48	96	2,750	3	BU-724896CS♣	285	993.00	BU-724896CA♣	252	861.00	BU-7248C♣	73.0	243.00
96	48	96	2,150	4	BU-964896CS♣	351	1,209.00	BU-964896CA♣	318	1,077.00	BU-9648C♣	95.0	315.00
48	48	120	1,500	2	BU-4848120CS♣	223	820.00	BU-4848120CA♣	185	668.00	BU-4848C♣	49.0	172.00
72	48	120	2,750	3	BU-7248120CS♣	295	1,033.00	BU-7248120CA♣	257	881.00	BU-7248C♣	73.0	243.00
96	48	120	2,150	4	BU-9648120CS♣	361	1,249.00	BU-9648120CA♣	323	1,097.00	BU-9648C♣	95.0	315.00
Wire Decking**													
48	48	72	1,500	2	BU-484872WS♣	172	711.00	BU-484872WA♣	149	615.00	BU-4848W♣	42.0	173.00
72	48	72	2,750	3	BU-724872WS♣	235	873.00	BU-724872WA♣	212	777.00	BU-7248W♣	63.0	227.00
96	48	72	2,150	4	BU-964872WS♣	283	1,179.00	BU-964872WA♣	260	1,083.00	BU-9648W♣	79.0	329.00
48	48	84	1,500	2	BU-484884WS♣	180	656.00	BU-484884WA♣	153	656.00	BU-4848W♣	42.0	173.00
72	48	84	2,750	3	BU-724884WS♣	243	958.00	BU-724884WA♣	216	822.00	BU-7248W♣	63.0	227.00
96	48	84	2,150	4	BU-964884WS♣	291	1,263.00	BU-964884WA♣	264	1,127.00	BU-9648W♣	79.0	329.00
48	48	96	1,500	2	BU-484896WS♣	192	783.00	BU-484896WA♣	159	651.00	BU-4848W♣	42.0	173.00
72	48	96	2,750	3	BU-724896WS♣	255	945.00	BU-724896WA♣	222	813.00	BU-7248W♣	63.0	227.00
96	48	96	2,150	4	BU-964896WS♣	303	1,251.00	BU-964896WA♣	270	1,119.00	BU-9648W♣	79.0	329.00
48	48	120	1,500	2	BU-4848120WS♣	202	823.00	BU-4848120WA♣	164	671.00	BU-4848W♣	42.0	173.00
72	48	120	2,750	3	BU-7248120WS♣	265	985.00	BU-7248120WA♣	227	833.00	BU-7248W♣	63.0	227.00
96	48	120	2,150	4	BU-9648120WS♣	313	1,291.00	BU-9648120WA♣	275	1,139.00	BU-9648W♣	79.0	329.00
No Decking													
48	48	72	1,500	2	BU-484872S♣	109	411.00	BU-484872A♣	86	315.00	BU-4848♣	21.0	70.00
72	48	72	2,750	3	BU-724872S♣	139	496.00	BU-724872A♣	116	400.00	BU-7248♣	31.0	97.00
96	48	72	2,150	4	BU-964872S♣	157	579.00	BU-964872A♣	134	485.00	BU-9648♣	37.0	129.00
48	48	84	1,500	2	BU-484884S♣	117	491.00	BU-484884A♣	90	355.00	BU-4848♣	21.0	70.00
72	48	84	2,750	3	BU-724884S♣	147	576.00	BU-724884A♣	120	440.00	BU-7248♣	31.0	97.00
96	48	84	2,150	4	BU-964884S♣	165	661.00	BU-964884A♣	138	525.00	BU-9648♣	37.0	129.00
48	48	96	1,500	2	BU-484896S♣	129	484.00	BU-484896A♣	96	352.00	BU-4848♣	21.0	70.00
72	48	96	2,750	3	BU-724896S♣	159	569.00	BU-724896A♣	126	437.00	BU-7248♣	31.0	97.00
96	48	96	2,150	4	BU-964896S♣	179	651.00	BU-964896A♣	144	522.00	BU-9648♣	37.0	129.00
48	48	120	1,500	2	BU-4848120S♣	139	524.00	BU-4848120A♣	101	372.00	BU-4848♣	21.0	70.00
72	48	120	2,750	3	BU-7248120S♣	169	609.00	BU-7248120A♣	131	457.00	BU-7248♣	31.0	97.00
96	48	120	2,150	4	BU-9648120S♣	187	694.00	BU-9648120A♣	149	542.00	BU-9648♣	37.0	129.00

Standard Colors (Unless Otherwise Specified)



♣ Items with this symbol are available to ship in 2-3 days. Limited quantities and select colors. (MGY)

Bulk Storage: Components

BULK UPRIGHTS

CAT. NO.	W	D	H	WT.	PRICE
72" High					
BUF-2472♣	1 3/4	24	72	20	\$80.00
BUF-3672♣	1 3/4	36	72	22	87.00
BUF-4272*	1 3/4	42	72	22	127.00
BUF-4872♣	1 3/4	48	72	23	96.00
84" High					
BUF-2484♣	1 3/4	24	84	24	113.00
BUF-3684♣	1 3/4	36	84	25	120.00
BUF-4884♣	1 3/4	48	84	27	136.00
96" High					
BUF-2496♣	1 3/4	24	96	28	106.00
BUF-3696♣	1 3/4	36	96	30	119.00
BUF-4296*	1 3/4	42	96	32	146.00
BUF-4896♣	1 3/4	48	96	33	132.00
120" High					
BUF-24120♣	1 3/4	24	120	33	130.00
BUF-36120♣	1 3/4	36	120	36	140.00
BUF-42120*	1 3/4	42	120	37	204.00
BUF-48120♣	1 3/4	48	120	38	152.00
144" High					
BUF-24144*	1 3/4	24	144	40	202.00
BUF-36144*	1 3/4	36	144	43	216.00
BUF-48144*	1 3/4	48	144	46	211.00
168" High					
BUF-24168*	1 3/4	24	168	46	241.00
BUF-36168*	1 3/4	36	168	50	247.00
BUF-48168*	1 3/4	48	168	53	266.00
192" High					
BUF-24192*	1 3/4	24	192	53	257.00
BUF-36192*	1 3/4	36	192	57	264.00
BUF-48192*	1 3/4	48	192	64	277.00

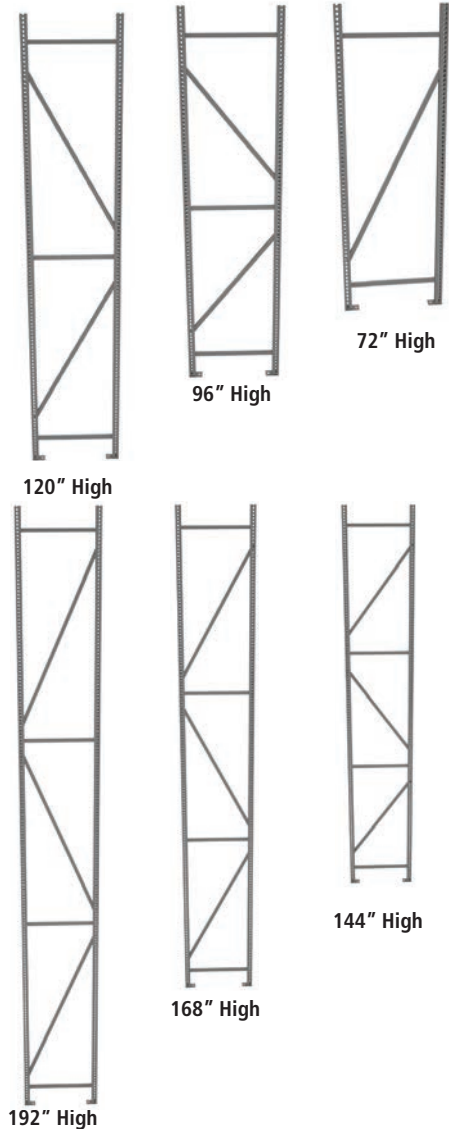

*Note: Quantities less than 50 uprights, please add \$250 list set-up charge. Other sizes available, contact factory for pricing.

For uprights without feet, add "NFP" to the catalog number, i.e. BUF-2472NFP.

17,000 lbs. capacity based on maximum vertical distance of 24" between any two beams on floor.

National Motor Freight Class: 70

RACK SPACER

CAT. NO.	W	D	H	WT.	PRICE
BRS-6	8 29/32	1	5 13/16	1.0	\$12.00

Mounting hardware is included with part.

National Motor Freight Class: 70

Used to attach back-to-back units. Maintains a 6" gap to meet fire codes.

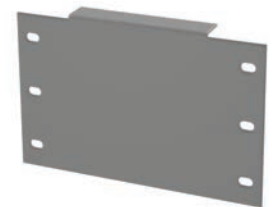

BULK UPRIGHT EXTENSION

CAT. NO.	W	D	H	WT.	PRICE
SPBUF-10	8 29/32	1 1/2	5 13/16	3.3	\$11.70

Mounting hardware is included with part.

National Motor Freight Class: 70

Used to splice two bulk frames together for additional height.

Top upright must be ordered without welded feet.



Standard Colors



♣ Items with these symbols are available to ship in 2-3 days. Limited quantities and select colors.



DECKING TYPES



Units are intended to be hand loaded only.

*Wire decking uses 5 gauge wire and consists of a 2" x 4" mesh pattern. Price shown for wire decking is for Medium Grey. For price of Sand or Light Grey, add a 10% upcharge.

**All corrugated decking comes in 12" wide sections

National Motor Freight Class: 70

CAT. NO.	W	D	H	WT.	PRICE
Wire Decking*					
ZWD-4824♣	48	24	5/16	10.7	\$54.00
ZWD-4836♣	48	36	5/16	16.0	72.00
ZWD-4848♣	48	48	5/16	21.0	100.00
ZWD-6024	60	24	5/16	13.3	90.00
ZWD-6036♣	60	36	5/16	20.0	103.00
ZWD-6048	60	48	5/16	27.0	143.00
ZWD-7224♣	72	24	5/16	16.0	83.00
ZWD-7236♣	72	36	5/16	24.0	109.00
ZWD-7248♣	72	48	5/16	32.0	127.00
ZWD-9624♣	96	24	5/16	21.0	106.00
ZWD-9636♣	96	36	5/16	32.0	144.00
ZWD-9648♣	96	48	5/16	42.0	200.00
Corrugated Steel Decking**					
BSD-4824♣	48	24	9/16	14.0	53.00
BSD-4836♣	48	36	9/16	21.0	77.00
BSD-4848♣	48	48	9/16	28.0	99.00
BSD-6024♣	60	24	9/16	17.9	65.00
BSD-6036♣	60	36	9/16	26.0	93.00
BSD-6048♣	60	48	9/16	36.0	122.00
BSD-7224♣	72	24	9/16	21.0	76.00
BSD-7236♣	72	36	9/16	31.0	110.00
BSD-7248♣	72	48	9/16	42.0	143.00
BSD-9624♣	96	24	9/16	28.0	98.00
BSD-9636♣	96	36	9/16	40.0	143.00
BSD-9648♣	96	48	9/16	58.0	186.00
Particleboard Decking					
PB-4824□	48	24	5/8	20.0	16.70
PB-4836□	48	36	5/8	31.0	25.00
PB-4848□	48	48	5/8	40.0	35.00
PB-6024□	60	24	5/8	25.0	22.00
PB-6036□	60	36	5/8	37.5	34.00
PB-6048□	60	48	5/8	50.0	41.00
PB-7224□	72	24	5/8	30.0	29.00
PB-7236□	72	36	5/8	45.0	39.00
PB-7248□	72	48	5/8	60.0	51.00
PB-9624□	96	24	5/8	40.0	35.00
PB-9636□	96	36	5/8	60.0	52.00
PB-9648□	96	48	5/8	80.0	69.00

†Comes in two 48" wide sections.

DECK LEVELS



BPB-96-36

Includes two plywood beams, deck level reinforcements and safety plugs.

Additional Deck Level Reinforcements (BPS-dd) can be added for extra deck support and weight capacity.

National Motor Freight Class: 70

CAT. NO.	Reinforcements Included	Load Cap.	WT.	PRICE
BPB-48-24♣	2	4,150	18.1	\$64.00
BPB-48-36♣	2	3,000	18.5	68.00
BPB-48-48♣	2	1,500	21.0	73.00
BPB-60-24♣	2	3,800	21.0	74.00
BPB-60-36♣	2	3,800	23.0	78.00
BPB-60-48♣	2	3,800	23.0	83.00
BPB-72-24♣	3	2,750	25.0	88.00
BPB-72-36♣	3	2,750	27.0	93.00
BPB-72-48♣	3	2,750	31.0	100.00
BPB-96-24♣	4	2,150	34.0	113.00
BPB-96-36♣	4	2,150	37.0	120.00
BPB-96-48♣	4	2,150	37.0	129.00

DECK LEVEL REINFORCEMENTS



BPS-36

National Motor Freight Class: 70

CAT. NO.	W	D	H	WT.	PRICE
BPS-24♣	1	24	1 15/16	1.3	\$5.20
BPS-36♣	1	36	1 15/16	2.1	7.10
BPS-48♣	1	48	1 15/16	2.7	9.30

Standard Colors (Unless Otherwise Specified)



♣ □
Items with these symbols are available to ship in 2-3 days. Limited quantities and select colors.

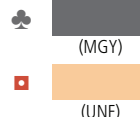

Bulk Storage: Components

BOX BEAMS (Sold in Pairs)

CAT. NO.	LOAD CAP.	RECOMMENDED # REINFORCEMENTS	W	D	H	WT.	PRICE
BHC-48	2700*	2	48 1/2	1 1/2	3	12.5	\$48.00
BHC-60	2500*	4	60 1/2	1 1/2	3	15.0	66.00
BHC-72	1800*	4	72 1/2	1 1/2	3	18.1	66.00
BHC-96	1400*	4	96 1/2	1 1/2	3	22.0	84.00



National Motor Freight Class: 70

*Capacity calculated for evenly distributed load using recommended number of box beam braces.

BOX BEAM BRACES

CAT. NO.	W	D	H	WT.	PRICE
SDS-24B	7/8	24	2 11/16	1.9	\$6.10
SDS-36B	7/8	36	2 11/16	2.8	8.60
SDS-42B	7/8	42	2 11/16	3.3	11.30
SDS-48B	7/8	48	2 11/16	3.9	11.40

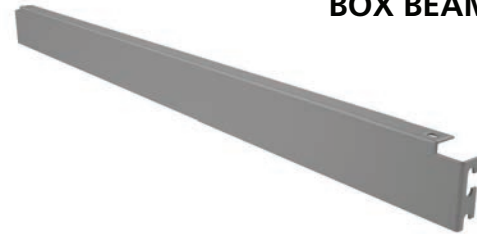

Provides center reinforcement for decking. Use with BHC only.

National Motor Freight Class: 70

WATERFALL STYLE WIRE DECKING

CAT. NO.	W	D	H	WT.	PRICE
BWD-4836	47	36	27/32	17.0	\$129.00
BWD-4848	47	48	27/32	21.5	137.00

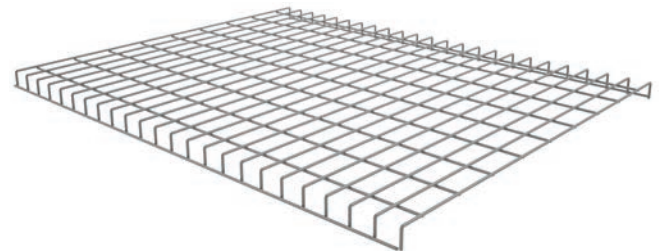

NOTE: Price shown is for Medium Grey. For price of Sand or Light Grey, add a 10% upcharge.

Meets factory mutual codes. 2" x 4" mesh pattern. 2 box beam braces (sold above) required per deck.

Other sizes available, Contact factory for details.

National Motor Freight Class: 70

Use with box beams (BHC-ww).

SADDLE CLIP

CAT. NO.	W	D	H	WT.	PRICE
SDLC-1	1 23/32	1	11/16	0.1	\$1.40
TECHSCREWS	—	—	—	0.1	.68



TECHSCREWS

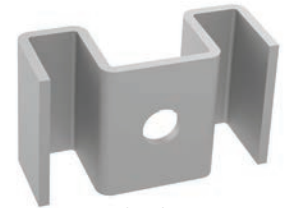

SDLC-1

National Motor Freight Class: 70

Used to hold down bar grating on a mezzanine. Attaches with one tech screw.

SAFETY PLUGS

CAT. NO.	W	D	H	WT.	PRICE
BSP-4	—	—	—	0.4	\$1.90



National Motor Freight Class: 70

Standard Colors



Sand (SND) Light Grey (LGY) Medium Grey (MGY)

Q-Line Industrial Clip Shelving

OPEN STYLE SHELVING

*Load capacities are based on evenly distributed loads.



- Starter Units Include:**
- 4 Offset Angle Posts
 - 2 Sets of Side Sway Braces
 - 1 Set of Back Sway Braces
 - 5 Steel Shelves

National Motor
Freight Class: 70

QOH5-3618S



- "AB" Adder Units Include:**
- 2 Offset Angle Posts
 - 1 Beaded Post
 - 1 Set of Side Sway Braces
 - 1 Set of Back Sway Braces
 - 5 Steel Shelves

National Motor
Freight Class: 70

QOH5-3618AB



- "A" Adder Units Include:**
- 4 Offset Angle Posts
 - 1 Set of Side Sway Braces
 - 1 Set of Back Sway Braces
 - 5 Steel Shelves

National Motor
Freight Class: 70

QOH5-3618A

UNIT SIZE			SHELF CAP.*	STARTER UNITS			ADDER UNITS			EXTRA SHELF					
W	D	H		CAT. NO.	WT.	PRICE	CAT. NO.	WT.	PRICE	CAT. NO.	WT.	PRICE			
20 Gauge, 5 Shelves															
36	12	87	1,000	QOH5-3612S♣	69	\$242.00	QOH5-3612AB♣	62	\$227.00	QOH5-3612A	66	\$236.00	Q-3612♣	8.0	\$29.00
48	12	87	650	QOH5-4812S♣	82	298.00	QOH5-4812AB♣	75	279.00	QOH5-4812A	79	287.00	Q-4812♣	10.4	40.00
36	18	87	850	QOH5-3618S♣	82	282.00	QOH5-3618AB♣	75	265.00	QOH5-3618A	79	276.00	Q-3618♣	10.5	37.00
48	18	87	550	QOH5-4818S♣	98	343.00	QOH5-4818AB♣	91	326.00	QOH5-4818A	95	333.00	Q-4818♣	13.6	49.00
36	24	87	800	QOH5-3624S♣	94	322.00	QOH5-3624AB♣	87	305.00	QOH5-3624A	91	316.00	Q-3624♣	13.0	45.00
48	24	87	550	QOH5-4824S♣	114	388.00	QOH5-4824AB♣	107	371.00	QOH5-4824A	111	378.00	Q-4824♣	16.8	58.00
22 Gauge, 5 Shelves															
36	12	87	750	QO5-3612S♣	63	227.00	QO5-3612AB♣	56	210.00	QO5-3612A	60	217.00	Q2-3612♣	6.7	26.00
48	12	87	500	QO5-4812S♣	73	263.00	QO5-4812AB♣	66	245.00	QO5-4812A	71	252.00	Q2-4812♣	8.7	33.00
36	18	87	750	QO5-3618S♣	73	262.00	QO5-3618AB♣	66	245.00	QO5-3618A	71	252.00	Q2-3618♣	8.8	33.00
48	18	87	500	QO5-4818S♣	87	308.00	QO5-4818AB♣	80	291.00	QO5-4818A	84	298.00	Q2-4818♣	11.4	42.00
36	24	87	700	QO5-3624S♣	84	297.00	QO5-3624AB♣	77	280.00	QO5-3624A	81	287.00	Q2-3624♣	10.9	40.00
48	24	87	450	QO5-4824S♣	100	353.00	QO5-4824AB♣	93	336.00	QO5-4824A	98	343.00	Q2-4824♣	14.1	51.00

CLOSED STYLE SHELVING

*Load capacities are based on evenly distributed loads.



- Starter Units Include:**
- 4 Offset Angle Posts
 - 2 Side Panels
 - 1 Back Panel
 - 5 Steel Shelves

National Motor
Freight Class: 70

QCH5-3618S



- "AB" Adder Units Include:**
- 2 Offset Angle Posts
 - 1 Beaded Post
 - 1 Side Panel
 - 1 Back Panel
 - 5 Steel Shelves

National Motor
Freight Class: 70

QCH5-3618AB



- "A" Adder Units Include:**
- 4 Offset Angle Posts
 - 1 Side Panel
 - 1 Back Panel
 - 5 Steel Shelves

National Motor
Freight Class: 70

QCH5-3618A

UNIT SIZE			SHELF CAP.*	STARTER UNITS			ADDER UNITS			EXTRA SHELF					
W	D	H		CAT. NO.	WT.	PRICE	CAT. NO.	WT.	PRICE	CAT. NO.	WT.	PRICE			
20 Gauge, 5 Shelves															
36	12	87	1,000	QCH5-3612S♣	95	\$352.00	QCH5-3612AB♣	85	\$320.00	QCH5-3612A	90	\$329.00	Q-3612♣	8.0	\$29.00
48	12	87	650	QCH5-4812S♣	116	433.00	QCH5-4812AB♣	106	403.00	QCH5-4812A	111	408.00	Q-4812♣	10.4	40.00
36	18	87	850	QCH5-3618S♣	116	420.00	QCH5-3618AB♣	101	374.00	QCH5-3618A	111	383.00	Q-3618♣	10.5	37.00
48	18	87	550	QCH5-4818S♣	140	508.00	QCH5-4818AB♣	126	462.00	QCH5-4818A	132	467.00	Q-4818♣	13.6	49.00
36	24	87	800	QCH5-3624S♣	135	480.00	QCH5-3624AB♣	117	425.00	QCH5-3624A	123	433.00	Q-3624♣	13.0	45.00
48	24	87	550	QCH5-4824S♣	163	573.00	QCH5-4824AB♣	145	517.00	QCH5-4824A	152	523.00	Q-4824♣	16.8	58.00
22 Gauge, 5 Shelves															
36	12	87	750	QC5-3612S♣	89	337.00	QC5-3612AB♣	78	305.00	QC5-3612A	83	312.00	Q2-3612♣	6.7	26.00
48	12	87	500	QC5-4812S♣	108	400.00	QC5-4812AB♣	97	368.00	QC5-4812A	102	375.00	Q2-4812♣	8.7	33.00
36	18	87	750	QC5-3618S♣	107	400.00	QC5-3618AB♣	93	354.00	QC5-3618A	97	361.00	Q2-3618♣	8.8	33.00
48	18	87	500	QC5-4818S♣	129	473.00	QC5-4818AB♣	115	427.00	QC5-4818A	119	434.00	Q2-4818♣	11.4	42.00
36	24	87	700	QC5-3624S♣	125	455.00	QC5-3624AB♣	107	399.00	QC5-3624A	111	406.00	Q2-3624♣	10.9	40.00
48	24	87	450	QC5-4824S♣	150	538.00	QC5-4824AB♣	132	482.00	QC5-4824A	136	489.00	Q2-4824♣	14.1	51.00

Standard Colors



♣ Items with this symbol are available to ship in 2-3 days. Limited quantities and select colors. (MGY)

Q-Line Shelving: Components

UPRIGHT POSTS

CAT. NO.	W	D	H	WT.	PRICE
Offset Angle Post					
OAP-39	1	1 7/8	39	2.4	\$7.60
OAP-48	1	1 7/8	48	2.9	9.20
OAP-51	1	1 7/8	51	3.1	9.90
OAP-75♣	1	1 7/8	75	4.6	13.80
OAP-84♣	1	1 7/8	84	5.1	15.60
OAP-87♣	1	1 7/8	87	5.3	16.10
OAP-96	1	1 7/8	96	5.9	18.10
OAP-99	1	1 7/8	99	6.0	19.50
OAP-108	1	1 7/8	108	6.8	23.00
OAP-111	1	1 7/8	111	6.8	20.00
OAP-123	1	1 7/8	123	7.5	23.00
Beaded T-Post					
BTP-39*	3/8	1 7/8	39	2.7	12.80
BTP-48*	3/8	1 7/8	48	3.4	15.40
BTP-51*	3/8	1 7/8	51	3.6	16.30
BTP-75♣	3/8	1 7/8	75	5.3	22.00
BTP-84♣	3/8	1 7/8	84	5.9	25.00
BTP-87♣	3/8	1 7/8	87	6.1	25.00
Heavy Duty Beaded T-Post					
HBP-39*	3/4	2 7/8	39	4.4	32.00
HBP-48*	3/4	2 7/8	48	5.4	35.00
HBP-51*	3/4	2 7/8	51	5.7	41.00
HBP-75*	3/4	2 7/8	75	8.4	44.00
HBP-84*	3/4	2 7/8	84	9.4	43.00
HBP-87♣	3/4	2 7/8	87	9.8	43.00
HBP-99♣	3/4	2 7/8	99	11.1	47.00
HBP-111*	3/4	2 7/8	111	12.5	51.00
HBP-123*	3/4	2 7/8	123	13.9	56.00

*Add \$600 net set-up charge.



OFFSET
ANGLE POST



INTERMEDIATE
BEADED POST



HEAVY-DUTY
INTERMEDIATE
BEADED POST

Post slotted for shelf adjustment on 1" centers. Total weight capacity not to exceed 5,000 lbs. per unit for OAP and HBP posts. Weight capacity not to exceed 3,500 lbs per unit for BTP posts. Capacities based upon 24" shelf centers or less.

National Motor Freight Class: 70

WELDED UPRIGHTS

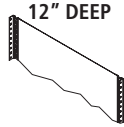
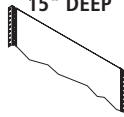
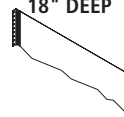
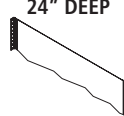
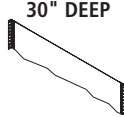
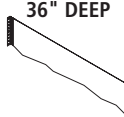
DEPTH	CAT. NO.	H	WT.	PRICE
12" DEEP 	WU-1239	39	7.1	\$47.00
	WU-1251	51	9.3	56.00
	WU-1275	75	13.7	66.00
	WU-1284	84	15.3	70.00
	WU-1287	87	15.8	74.00
15" DEEP 	WU-1539	39	8.0	48.00
	WU-1551	51	10.5	56.00
	WU-1575	75	15.5	71.00
	WU-1584	84	17.3	78.00
18" DEEP 	WU-1587	87	17.9	79.00
	WU-1839	39	9.1	52.00
	WU-1851	51	11.9	63.00
24" DEEP 	WU-1875	75	17.3	74.00
	WU-1884	84	19.6	88.00
	WU-1887	87	20.3	86.00
	WU-2439	39	10.3	58.00
30" DEEP 	WU-2451	51	13.4	70.00
	WU-2475	75	19.7	90.00
	WU-2484	84	22.1	105.00
	WU-2487	87	22.9	103.00
36" DEEP 	WU-3039	39	11.5	63.00
	WU-3051	51	15.1	78.00
	WU-3075	75	22.1	111.00
	WU-3084	84	24.8	121.00
36" DEEP	WU-3087	87	25.7	123.00
	WU-3639	39	13.0	70.00
	WU-3651	51	17.0	84.00
	WU-3675	75	25.0	122.00
36" DEEP	WU-3684	84	28.0	133.00
	WU-3687	87	29.0	137.00

National Motor Freight Class: 70



These are panels welded to OAP style posts. For quantities of less than 50 pieces, add \$100/list setup charge. Contact factory for pricing on intermediate welded uprights.

Standard Colors



♣ Items with these symbols are available to ship in 2-3 days. Limited quantities and select colors.



Q-Line Shelving: Components

BACK PANELS









*NOTE: 42" & 48" backs consist of two pieces.

CAT. NO.	H	WT.	PRICE
36" Wide			
BP-3639	39	9.8	\$44.00
BP-3648	48	12.1	52.00
BP-3651	51	12.9	55.00
BP-3675♣	75	18.9	78.00
BP-3684♣	84	21.0	86.00
BP-3687♣	87	22.0	91.00
42" Wide*			
BP-4239	39	11.8	56.00
BP-4248	48	14.5	65.00
BP-4251	51	15.4	70.00
BP-4275	75	23.0	96.00
BP-4284	84	25.0	107.00
BP-4287	87	26.0	109.00
48" Wide*			
BP-4839	39	14.0	63.00
BP-4848	48	17.0	73.00
BP-4851	51	18.1	79.00
BP-4875	75	27.0	107.00
BP-4884	84	30.0	120.00
BP-4887♣	87	31.0	119.00

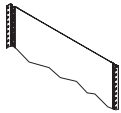
National Motor Freight Class: 70

END PANELS



DEPTH	CAT. NO.	H	WT.	PRICE
12" DEEP 	EP-1239	39	2.7	\$12.70
	EP-1248	48	3.3	15.70
	EP-1251	51	3.5	17.90
	EP-1275	75	5.1	24.00
	EP-1284	84	5.7	26.00
	EP-1287♣	87	6.0	25.00
15" DEEP 	EP-1539	39	3.7	17.70
	EP-1548	48	4.5	21.00
	EP-1551	51	4.8	22.00
	EP-1575	75	7.1	30.00
	EP-1584	84	7.9	33.00
	EP-1587	87	8.2	33.00
18" DEEP 	EP-1839	39	4.5	21.00
	EP-1848	48	5.5	24.00
	EP-1851	51	5.9	26.00
	EP-1875♣	75	8.6	35.00
	EP-1884♣	84	9.6	36.00
	EP-1887♣	87	10.0	39.00
24" DEEP 	EP-2439	39	6.8	27.00
	EP-2448	48	7.5	31.00
	EP-2451	51	8.0	31.00
	EP-2475	75	11.7	44.00
	EP-2484	84	13.1	49.00
	EP-2487♣	87	13.6	49.00
30" DEEP 	EP-3039	39	7.9	31.00
	EP-3048	48	9.7	38.00
	EP-3051	51	10.3	41.00
	EP-3075	75	15.2	57.00
	EP-3084	84	17.0	64.00
	EP-3087	87	17.6	66.00
36" DEEP 	EP-3639	39	9.8	38.00
	EP-3648	48	12.1	44.00
	EP-3651	51	12.9	49.00
	EP-3675	75	18.9	68.00
	EP-3684	84	21.0	75.00
	EP-3687	87	22.0	79.00

National Motor Freight Class: 70

Standard Colors



Items with this symbol are available to ship in 2-3 days. Limited quantities and select colors.



(MGY)

Q-Line Shelving: Components

SHELVES

CAT. NO.	Load Cap.	W	D	H	WT.	PRICE
22 Gauge						
Q2-3612♣	750	36	12	1 5/16	6.7	\$26.00
Q2-3615♣	750	36	15	1 5/16	7.8	32.00
Q2-3618♣	750	36	18	1 5/16	8.8	33.00
Q2-3624♣	700	36	24	1 5/16	10.9	40.00
Q2-3630*♣	600	36	30	1 5/16	12.9	53.00
Q2-4212♣	600	42	12	1 5/16	7.7	34.00
Q2-4215♣	600	42	15	1 5/16	8.9	38.00
Q2-4218♣	600	42	18	1 5/16	10.1	40.00
Q2-4224♣	550	42	24	1 5/16	12.5	48.00
Q2-4230*♣	500	42	30	1 5/16	14.8	59.00
Q2-4812♣	500	48	12	1 5/16	8.7	33.00
Q2-4815♣	500	48	15	1 5/16	10.1	43.00
Q2-4818♣	500	48	18	1 5/16	11.4	42.00
Q2-4824♣	450	48	24	1 5/16	14.1	51.00
Q2-4830*♣	400	48	30	1 5/16	16.7	69.00
20 Gauge						
Q-3612	1,000	36	12	1 5/16	8.0	29.00
Q-3615*	900	36	15	1 5/16	9.3	36.00
Q-3618♣	850	36	18	1 5/16	10.5	37.00
Q-3624♣	800	36	24	1 5/16	13.0	45.00
Q-3630*	800	36	30	1 5/16	15.4	60.00
Q-3636*	600	36	36	1 5/16	17.9	72.00
Q-4212*	800	42	12	1 5/16	9.2	35.00
Q-4215*	700	42	15	1 5/16	10.6	44.00
Q-4218	650	42	18	1 5/16	12.0	44.00
Q-4224	650	42	24	1 5/16	14.9	54.00
Q-4230*	600	42	30	1 5/16	17.7	67.00
Q-4236*	550	42	36	1 5/16	21.0	78.00
Q-4812	650	48	12	1 5/16	10.4	40.00
Q-4815*	600	48	15	1 5/16	12.0	50.00
Q-4818	550	48	18	1 5/16	13.6	49.00
Q-4824♣	550	48	24	1 5/16	16.8	58.00
Q-4830*	500	48	30	1 5/16	19.9	75.00
Q-4836*	450	48	36	1 5/16	23.0	86.00

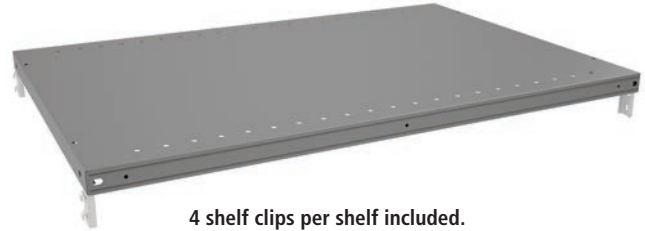

4 shelf clips per shelf included.



Shelves have a welded box formed construction with lapped and welded corners.

CAT. NO.	Load Cap.	W	D	H	WT.	PRICE
20 Gauge With Stiffeners**						
Q-3624-S*	1,000	36	24	1 5/16	15.4	\$70.00
Q-3630-S*	1,000	36	30	1 5/16	18.1	82.00
Q-3636-S*	750	36	36	1 5/16	21.0	98.00
Q-4224-S*	800	42	24	1 5/16	17.6	81.00
Q-4230-S*	750	42	30	1 5/16	21.0	97.00
Q-4236-S*	700	42	36	1 5/16	24.0	108.00
Q-4824-S*	700	48	24	1 5/16	19.8	89.00
Q-4830-S*	650	48	30	1 5/16	23.0	107.00
Q-4836-S*	600	48	36	1 5/16	27.0	121.00

*For quantities less than 250, add \$300 list set-up charge.

**Bin dividers cannot be used on shelves with stiffeners.

National Motor Freight Class: 70

CAT. NO.	Load Cap.	W	D	H	WT.	PRICE
PQ2-3612P	450	36	12	1 5/16	5.8	\$31.00
PQ2-3615P	450	36	15	1 5/16	6.7	43.00
PQ2-3618P	450	36	18	1 5/16	7.5	44.00
PQ2-3624P	450	36	24	1 5/16	9.2	49.00
PQ2-3630P	450	36	30	1 5/16	9.4	54.00
PQ2-4215P	375	42	15	1 5/16	7.6	38.00
PQ2-4224P	325	42	24	1 5/16	10.5	49.00
PQ2-4230P	275	42	30	1 5/16	12.9	66.00
PQ2-4812P	300	48	12	1 5/16	7.4	37.00
PQ2-4815P	300	48	15	1 5/16	8.5	42.00
PQ2-4818P	300	48	18	1 5/16	9.6	48.00
PQ2-4824P	250	48	24	1 5/16	11.7	58.00
PQ2-4830P	200	48	30	1 5/16	13.9	65.00
PQ2-4836P	175	48	36	1 5/16	16.2	84.00

PERFORATED SHELVES



4 shelf clips per shelf included.

National Motor Freight Class: 70

CAT. NO.	W	D	H	WT.	PRICE
LH-36♣	36	3/16	7/8	0.3	\$3.10
LH-42	42	3/16	7/8	0.4	3.30
LH-48♣	48	3/16	7/8	0.5	3.60

SHELF LABEL HOLDERS



Attachment plugs included.

National Motor Freight Class: 70

CAT. NO.	W	D	H	WT.	PRICE
T-1	1	1/2	2 3/4	0.1	\$0.58

REPLACEMENT SHELF CLIPS



Attaches shelves to uprights. Shelf clips are Zinc Plated.

National Motor Freight Class: 70

Standard Colors (Unless Otherwise Specified)



♣ Items with these symbols are available to ship in 2-3 days. Limited quantities and select colors.



Q-Line Shelving: Components

BIN DIVIDERS



*For quantities of less than 250 pieces, add \$300/list setup charge.

CAT. NO.	W	D	H	WT.	PRICE
12" Deep					
BD-1206	7/32	12	6	0.6	\$4.70
BD-1209	7/32	12	9	1.0	5.80
BD-1212	7/32	12	12	1.3	8.70
BD-1215*	7/32	12	15	1.6	8.70
BD-1218	7/32	12	18	1.9	9.30
15" Deep					
BD-1506*	7/32	15	6	1.0	7.10
BD-1509*	7/32	15	9	1.3	8.10
BD-1512*	7/32	15	12	1.8	9.90
BD-1515*	7/32	15	15	2.0	11.90
BD-1518*	7/32	15	18	2.7	13.50
18" Deep					
BD-1806	7/32	18	6	1.2	7.10
BD-1809	7/32	18	9	1.5	8.10
BD-1812♣	7/32	18	12	2.0	9.90
BD-1815	7/32	18	15	2.5	11.90
BD-1818	7/32	18	18	3.0	13.50

National Motor Freight Class: 70

BIN FRONTS

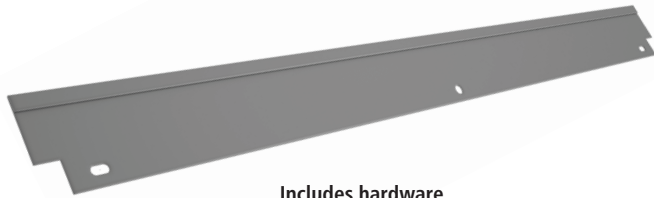

Includes hardware.

CAT. NO.	W	D	H	WT.	PRICE
BF-362♣	36	3/64	2	1.3	\$8.80
BF-422♣	42	3/64	2	1.5	9.70
BF-482♣	48	3/64	2	1.7	10.60

National Motor Freight Class: 70

END SWAY PLATES



Used as an alternative to Sway Braces.
Includes hardware.

CAT. NO.	W	D	H	WT.	PRICE
ESP-12	—	12 5/8	5	1.2	\$7.80
ESP-18	—	18 5/8	5	2.0	10.00
ESP-24	—	24 5/8	5	2.8	12.40

National Motor Freight Class: 70

FOOT PLATE



Used to secure uprights to the floor.

CAT. NO.	W	D	H	WT.	PRICE
FP-1	1 1/2	1/16	2 1/4	0.1	\$0.92

National Motor Freight Class: 70

SEISMIC FOOT PLATE



Single Foot Plate for OAP



Two Foot Plates for HBP

CAT. NO.	W	D	H	WT.	PRICE
IFF-1	3 1/4	1 5/8	2 1/2	0.4	\$4.60

Order one foot plate for each OAP upright and two foot plates back-to-back for each HBP upright, as shown.
When seismic foot is used, bottom shelf is 6 9/32" above floor.

National Motor Freight Class: 70

Standard Colors



Items with this symbol are available to ship in 2-3 days. Limited quantities and select colors.



Q-Line Shelving: Components

SLIDING DIVIDERS

CAT. NO.	H	WT.	PRICE
12" Deep			
SD-1230	3	0.7	\$10.00
SD-1245	4 1/2	0.9	10.80
SD-1260	6	1.0	11.50
18" Deep			
SD-1830	3	1.1	12.20
SD-1845	4 1/2	1.4	13.10
SD-1860	6	1.6	14.10
24" Deep			
SD-2430	3	1.5	13.30
SD-2445	4 1/2	1.8	14.60
SD-2460	6	2.0	15.70

National Motor Freight Class: 70



FRONT BASE STRIPS

CAT. NO.	W	D	H	WT.	PRICE
FBS-362♣	36	1/2	1 7/8	1.2	\$9.10
FBS-422	42	1/2	1 7/8	1.5	9.70
FBS-482♣	48	1/2	1 7/8	1.7	10.50

National Motor Freight Class: 70

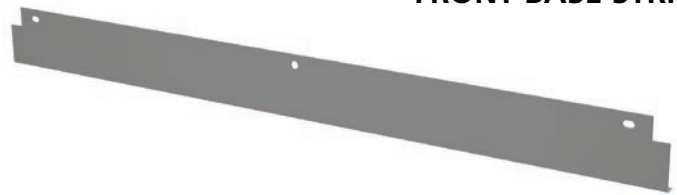

MEZZANINE BRACKETS

CAT. NO.	W	D	H	WT.	PRICE
For Offset Angle Post					
MB-3	1 1/16	2 1/4	3	0.5	\$4.30
For Heavy Duty Beaded Post					
BMB-3	1 5/32	3 13/16	3	0.5	5.10

National Motor Freight Class: 70

Includes hardware.

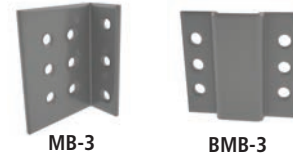

MB-3

BMB-3

GUSSETS

CAT. NO.	DESCRIPTION	WT.	PRICE
AG-6	Corner Gusset (ea.)	0.1	\$3.50
BG-6	Beaded "T" Gusset (pr.)	0.2	14.40

Can be used in place of sway braces.

National Motor Freight Class: 70



Corner Gusset



Beaded "T"
Gussets
(1 pair)

SPLICE PLATES

CAT. NO.	W	D	H	WT.	PRICE
For Offset Angle Post					
SPOA-4	27/32	1 1/8	4	0.3	\$4.00
For Heavy Duty Beaded Post					
SPBT-5	5/8	2 7/16	5	0.5	12.30

National Motor Freight Class: 70

Includes hardware.



SPOA-4

SPBT-5

SHELF BOXES

CAT. NO.	W	D	H	WT.	PRICE
Shelf Boxes					
BX-512	5 5/8	11	4 9/16	2.5	\$16.80
BX-518	5 5/8	17	4 9/16	3.3	19.50
BX-812	8 3/8	11	4 9/16	3.5	20.00
BX-818	8 3/8	17	4 9/16	4.3	24.00
BX-1112	11 1/4	11	4 9/16	4.5	24.00
BX-1118	11 1/4	17	4 9/16	5.3	29.00
Shelf Box Dividers*					
BXD-5	5 3/16	1/32	4 1/2	0.2	1.10
BXD-8	8	1/32	4 1/2	0.3	1.40
BXD-11	10 7/8	1/32	4 1/2	0.4	1.90
Shelf Box Guides**					
BXG-12	11 7/8	3/4	2 3/4	0.8	13.30
BXG-18	17 7/8	3/4	2 3/4	1.0	14.70

*Dividers are galvanized, not painted.

**Guides are priced per pair. Includes hardware.



National Motor Freight Class: 70

Standard Colors (Unless Otherwise Specified)



Sand (SND) Light Grey (LGY) Medium Grey (MGY)

♣ Items with these symbols are available to ship in 2-3 days. Limited quantities and select colors.



Sway Braces & Hinged Doors

END SWAY BRACES (Sold in Pairs)

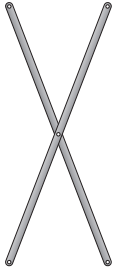

Includes hardware.

CAT. NO.	Shelf Depth	WT.	PRICE
ESB-1224♣	12" to 24"	2.4	\$9.50
ESB-3036♣	30" to 36"	3.1	11.10

NOTE: Use two pair for uprights 96"-137"
and three pair for uprights 138" and higher.

National Motor Freight Class: 70

REAR SWAY BRACES (Sold in Pairs)

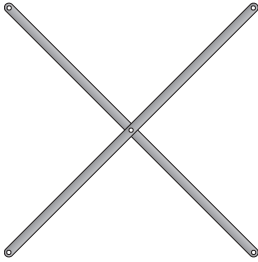

Includes hardware.

CAT. NO.	Unit Length	WT.	PRICE
RSBU♣	36" to 42"	3.2	\$11.70
RSB-48♣	48"	3.7	12.70

NOTE: Use two pair for uprights 96"-137"
and three pair for uprights 138" and higher.

National Motor Freight Class: 70

HINGED DOOR SHELVING UNITS (8 Shelves, 7 Openings)



CAT. NO.	W	D	H	WT.	PRICE
HDS-8712RH♣	36	12*	87	172	\$821.00
HDS-8718RH♣	36	18*	87	197	905.00
HDS-8724RH♣	36	24*	87	221	981.00

*Unit depth does not include 1 1/4" depth
of door frame or 1/2" depth of handle.

NOTE: Hinged door shelving units available in Medium Grey only.

Hinged doors come standard with one recessed handle.

National Motor Freight Class: 70

HINGED DOORS



CAT. NO.	W	D	H	WT.	PRICE
Full-Height Hinged Doors					
HD-3687RH♣	36	1 1/4*	87	63	\$405.00

* Depth does not include 1/2" depth of handle.

NOTE: Hinged doors available in medium grey only.

Hinged doors come standard with one recessed handle.

Assembly Required.

National Motor Freight Class: 70

Standard Colors (Unless Otherwise Specified)



Items with this symbol are
available to ship in 2-3 days.
Limited quantities
and select colors.



(MGY)

Slotted Angle & Packing Table

SLOTTED ANGLE

CAT. NO.	GAUGE	LENGTH	WT.	PRICE
SA-1410P	14	120	7.3	\$38.00
SA-1412P	14	144	8.8	41.00

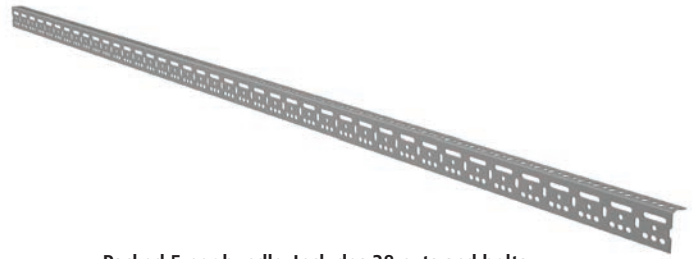

Packed 5 per bundle. Includes 38 nuts and bolts.

National Motor Freight Class: 70

PACKING TABLES

CAT. NO.	W	D	H	WT.	PRICE
Packing Table with Steel Top					
APT-3072S	72	30	83 7/16	252	\$1,201.00
APT-3672S	72	36	83 7/16	271	1,260.00
Packing Table with Hardwood Top					
APT-3072W	72	30	83 7/16	275	1,525.00
APT-3672W	72	36	83 7/16	295	1,634.00

Available in Medium Grey only.

National Motor Freight Class: 70

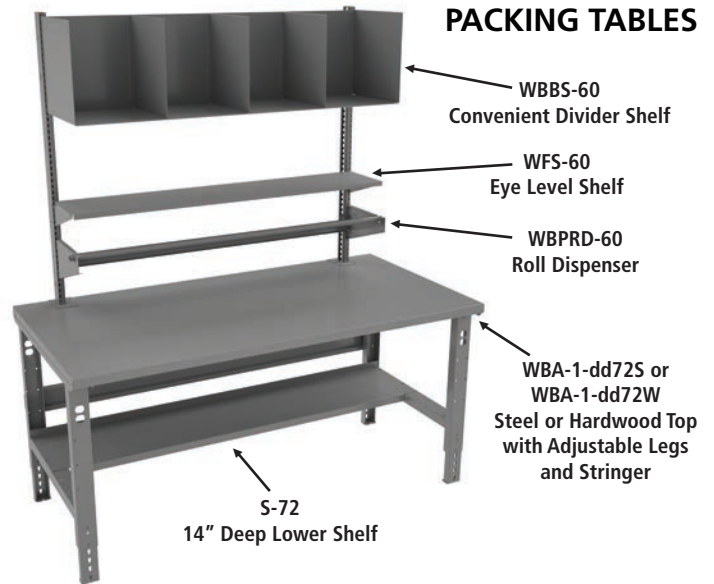

PACKING TABLE ACCESSORIES

CAT. NO.	W	D	H	WT.	PRICE
Power Rail					
PTP-60*	57 3/32	2 1/2	1 3/4	12	\$288.00
Bin Rail					
TWBR-60*	57 7/32	3 7/8	4 3/16	7	116.00
Task Light					
TWCTL-48	50 5/32	8	1 25/32	14	199.00
Task Light Bracket Kit*					
TWLB-60	60	13 1/2	3 1/2	8.2	52.00

*Task Light Bracket Kit required for Task Light.

*Available in Medium Grey only.

National Motor Freight Class: 70

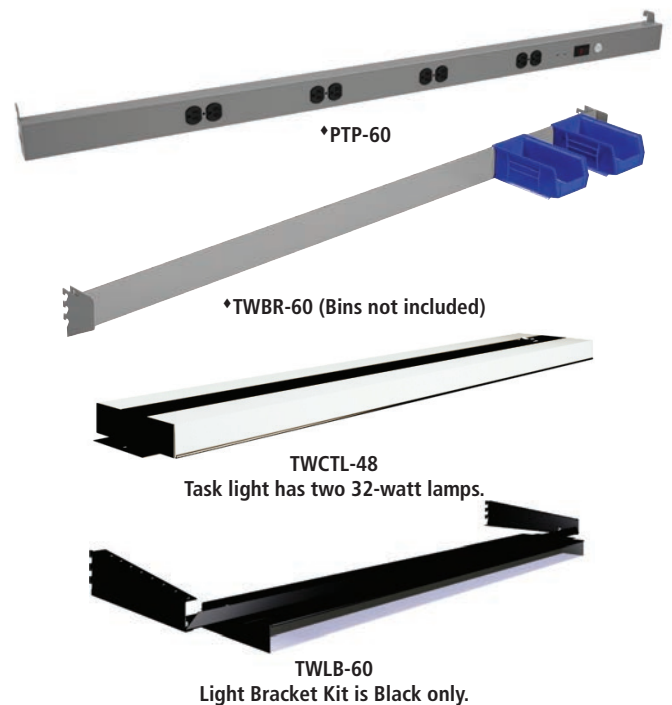

SHELVING

SHOP EQUIPMENT

Standard Colors (Unless Otherwise Specified)



Flared & Adjustable Leg Workbenches

FLARED LEG WORKBENCHES



Steel Top with Flared Legs



Plastic Top with Flared Legs



Butcher Block Top with Flared Legs



Compressed Top with Flared Legs

National Motor Freight Class: 70

CAT. NO.	LOAD CAP.	W	D	H	WT.	PRICE
Steel Top						
WB-1-3048S♣	4,000	48	30	33 1/2	91	\$378.00
WB-1-3060S♣	2,500	60	30	33 1/2	103	397.00
WB-1-3072S♣	1,800	72	30	33 1/2	120	440.00
WB-1-3096S*♣	4,000	96	30	33 1/2	173	611.00
WB-1-3660S♣	2,500	60	36	33 1/2	122	458.00
WB-1-3672S♣	1,800	72	36	33 1/2	134	499.00
WB-1-3696S*♣	4,000	96	36	33 1/2	192	676.00
Plastic Top						
WB-1-3048P♣	1,200	48	30	33 1/2	126	482.00
WB-1-3060P♣	800	60	30	33 1/2	123	493.00
WB-1-3072P♣	750	72	30	33 1/2	139	559.00
WB-1-3096P*♣	1,200	96	30	33 1/2	190	804.00
WB-1-3660P♣	800	60	36	33 1/2	150	615.00
WB-1-3672P♣	750	72	36	33 1/2	182	641.00
WB-1-3696P*♣	1,200	96	36	33 1/2	225	915.00
Butcher Block Top						
WB-1-3048W♣	4,000	48	30	33 3/4	96	589.00
WB-1-3060W♣	3,800	60	30	33 3/4	124	656.00
WB-1-3072W♣	3,600	72	30	33 3/4	142	757.00
WB-1-3096W*♣	4,000	96	30	33 3/4	184	1,048.00
WB-1-3660W♣	3,800	60	36	33 3/4	137	762.00
WB-1-3672W♣	3,600	72	36	33 3/4	162	873.00
WB-1-3696W*♣	4,000	96	36	33 3/4	217	1,492.00
Compressed Wood Top						
WB-1-3048C♣	2,400	48	30	33 3/4	124	481.00
WB-1-3060C♣	1,900	60	30	33 3/4	152	511.00
WB-1-3072C♣	1,500	72	30	33 3/4	175	575.00
WB-1-3096C*♣	2,400	96	30	33 3/4	233	927.00
WB-1-3660C♣	1,900	60	36	33 3/4	169	605.00
WB-1-3672C♣	1,500	72	36	33 3/4	206	672.00
WB-1-3696C*♣	2,400	96	36	33 3/4	270	953.00

*96" w workbenches have 3 sets of legs.

ADJUSTABLE LEG WORKBENCHES



Steel Top with Adjustable Legs



Plastic Top with Adjustable Legs



Butcher Block Top with Adjustable Legs



Compressed Top with Adjustable Legs

National Motor Freight Class: 70

CAT. NO.	LOAD CAP.	W	D	H	WT.	PRICE
Steel Top						
WBA-1-3048S♣	4,000	48	30	27 7/8-35 3/8	98	\$392.00
WBA-1-3060S♣	2,500	60	30	27 7/8-35 3/8	110	411.00
WBA-1-3072S♣	1,800	72	30	27 7/8-35 3/8	127	454.00
WBA-1-3096S*♣	4,000	96	30	27 7/8-35 3/8	182	632.00
WBA-1-3660S♣	2,500	60	36	27 7/8-35 3/8	129	472.00
WBA-1-3672S♣	1,800	72	36	27 7/8-35 3/8	141	513.00
WBA-1-3696S*♣	4,000	96	36	27 7/8-35 3/8	202	697.00
Plastic Top						
WBA-1-3048P♣	1,200	48	30	27 7/8-35 3/8	115	496.00
WBA-1-3060P♣	800	60	30	27 7/8-35 3/8	130	507.00
WBA-1-3072P♣	750	72	30	27 7/8-35 3/8	145	573.00
WBA-1-3096P*♣	1,200	96	30	27 7/8-35 3/8	200	825.00
WBA-1-3660P♣	800	60	36	27 7/8-35 3/8	157	630.00
WBA-1-3672P♣	750	72	36	27 7/8-35 3/8	188	655.00
WBA-1-3696P*♣	1,200	96	36	27 7/8-35 3/8	235	936.00
Butcher Block Top						
WBA-1-3048W♣	4,000	48	30	27 7/8-35 3/8	109	603.00
WBA-1-3060W♣	3,800	60	30	27 7/8-35 3/8	131	670.00
WBA-1-3072W♣	3,600	72	30	27 7/8-35 3/8	148	771.00
WBA-1-3096W*♣	4,000	96	30	27 7/8-35 3/8	194	1,069.00
WBA-1-3660W♣	3,800	60	36	27 7/8-35 3/8	144	776.00
WBA-1-3672W♣	3,600	72	36	27 7/8-35 3/8	168	887.00
WBA-1-3696W*♣	4,000	96	36	27 7/8-35 3/8	227	1,513.00
Compressed Wood Top						
WBA-1-3048C♣	2,400	48	30	27 7/8-35 3/8	131	495.00
WBA-1-3060C♣	1,900	60	30	27 7/8-35 3/8	159	525.00
WBA-1-3072C♣	1,500	72	30	27 7/8-35 3/8	181	589.00
WBA-1-3096C*♣	2,400	96	30	27 7/8-35 3/8	238	948.00
WBA-1-3660C♣	1,900	60	36	27 7/8-35 3/8	176	619.00
WBA-1-3672C♣	1,500	72	36	27 7/8-35 3/8	212	686.00
WBA-1-3696C*♣	2,400	96	36	27 7/8-35 3/8	280	974.00

*96" w workbenches have 3 sets of legs.

Standard Colors



Items with this symbol are available to ship in 2-3 days. Limited quantities and select colors.



(MGY)

Electronic Workbenches

ELECTRONIC WORKBENCHES



EB-1-3072S
Solid Steel Top
Electronic Workbench



EB-2-3072M
Hard Wood Top
Electronic Workbench
With Electronic Riser

- Assembly required.

CAT. NO.	TOP MATERIAL	W	D	H	LOAD CAP.*	WT.	PRICE
Electronic Workbench with Stringer and Outlet Panel							
EB-1-3072S♣	Solid Steel	72	30	33 1/2	1,800	156	\$643.00
EB-1-3072M♣	Hard Wood	72	30	33 3/4	2,000	178	960.00
EB-1-3672M♣	Hard Wood	72	36	33 3/4	2,000	195	1,066.00
EB-1-3072P♣	Plastic Laminate	72	30	33 1/2	750	175	762.00
EB-1-3672P♣	Plastic Laminate	72	36	33 1/2	750	215	834.00
EB-1-3072C♣	Compressed Wood	72	30	33 3/4	1,500	211	778.00
EB-1-3672C♣	Compressed Wood	72	36	33 3/4	1,500	239	865.00
Electronic Workbench with Stringer, Outlet Panel and Electronic Riser							
EB-2-3072S♣	Solid Steel	72	30	33 1/2	1,800	187	777.00
EB-2-3072M♣	Hard Wood	72	30	33 3/4	2,000	209	1,094.00
EB-2-3672M♣	Hard Wood	72	36	33 3/4	2,000	226	1,200.00
EB-2-3072P♣	Plastic Laminate	72	30	33 1/2	750	206	896.00
EB-2-3672P♣	Plastic Laminate	72	36	33 1/2	750	246	968.00
EB-2-3072C♣	Compressed Wood	72	30	33 3/4	1,500	242	912.00
EB-2-3672C♣	Compressed Wood	72	36	33 3/4	1,500	270	999.00

*Load capacity is for top only. This is not the represented load capacity for riser.

Includes top, panel legs and electronic outlet panel. Electronic wiring kit is not included with outlet panel. Wiring kit (WK-1) must be ordered separately.

National Motor Freight Class: 70

ELECTRONIC MODULAR WORKBENCHES



EMB-1-3072S
Solid Steel Top
Electronic Modular
Workbench



EMB-2-3072M
Hard Wood Top
Electronic Modular
Workbench

- Assembly required.

CAT. NO.	TOP MATERIAL	W	D	H	LOAD CAP.	WT.	PRICE
EMB-1-3072S*♣	Solid Steel w/ 2 Drawer Units	72	30	33 1/2	1,800	248	\$1,518.00
EMB-1-3072M*♣	Hard Wood w/ 2 Drawer Units	72	30	33 3/4	2,000	267	1,825.00
EMB-1-3072P*♣	Plastic Laminate w/ 2 Drawer Units	72	30	33 1/2	750	264	1,627.00
EMB-1-3072C*♣	Compressed Wood w/ 2 Drawer Units	72	30	33 3/4	1,500	300	1,643.00
EMB-2-3072S**♣	Solid Steel w/ 1 Drawer & Cabinet	72	30	33 1/2	1,800	219	1,244.00
EMB-2-3072M**♣	Hard Wood w/ 1 Drawer & Cabinet	72	30	33 3/4	2,000	238	1,551.00
EMB-2-3072P**♣	Plastic Laminate w/ 1 Drawer & Cabinet	72	30	33 1/2	750	235	1,353.00
EMB-2-3072C**♣	Compressed Wood w/ 1 Drawer & Cabinet	72	30	33 3/4	1,500	271	1,369.00

Load capacity is for top only.

* Includes top, two modular drawer units and electric outlet panel. Electric wiring kit is not included with outlet panel.

** Includes top, one modular drawer unit, one modular cabinet unit and electric outlet panel. Electric wiring kit is not included with outlet panel.

Wiring kit (WK-1) must be ordered separately.

National Motor Freight Class: 70

Standard Colors



♣ Items with these symbols are available to ship in 2-3 days. Limited quantities and select colors.



Workbench Tops

STEEL TOPS



*96" w tops require three legs.
Durable 12 gauge steel work surface reinforced with 14 gauge mounting brackets. Includes two mounting brackets (enough to mount one workbench drawer or two modular cabinets).

Stringer required for workbenches with legs & no pedestals.

National Motor Freight Class: 70

CAT. NO.	LOAD CAP.	W	D	H	WT.	PRICE
With Stringer						
T-3048♣	4,000	48	30	1 1/2	62	\$260.00
T-3060♣	2,500	60	30	1 1/2	74	279.00
T-3072♣	1,800	72	30	1 1/2	91	322.00
T-3096*♣	4,000	96	30	1 1/2	129	434.00
T-3648♣	4,000	48	36	1 1/2	71	278.00
T-3660♣	2,500	60	36	1 1/2	90	330.00
T-3672♣	1,800	72	36	1 1/2	107	371.00
T-3696*♣	4,000	96	36	1 1/2	144	484.00
Without Stringer						
G-T-3048	4,000	48	30	1 1/2	57	243.00
G-T-3060♣	2,500	60	30	1 1/2	69	260.00
G-T-3072♣	1,800	72	30	1 1/2	84	298.00
G-T-3096*	4,000	96	30	1 1/2	116	405.00
G-T-3648	4,000	48	36	1 1/2	66	263.00
G-T-3660	2,500	60	36	1 1/2	83	311.00
G-T-3672	1,800	72	36	1 1/2	97	347.00
G-T-3696*♣	4,000	96	36	1 1/2	131	464.00

STEEL TOPS WITH HARD BOARD



1/8" hardboard helps to deaden sound of items placed or used on work surface and protects durable 12 gauge steel work surface from scratches. Reinforced with 14 gauge mounting brackets. Includes two mounting brackets (enough to mount one workbench drawer or two modular cabinets).

Stringer required for workbenches with legs & no pedestals.

National Motor Freight Class: 70

CAT. NO.	LOAD CAP.	W	D	H	WT.	PRICE
With Stringer						
THB-3060	2,500	60	30	1 1/2	78	\$380.00
THB-3072	1,800	72	30	1 1/2	99	431.00
THB-3672	1,800	72	36	1 1/2	119	452.00
Without Stringer						
G-THB-3060	2,500	60	30	1 1/2	72	287.00
G-THB-3072	1,800	72	30	1 1/2	92	391.00
G-THB-3672	1,800	72	36	1 1/2	109	432.00

HARDWOOD TOPS



*96" w tops require three legs.
Features assorted hardwoods in a butcher-block construction to resist warp.

Stringer required for workbenches with legs & no pedestals.

Available in Natural only.

National Motor Freight Class: 70

CAT. NO.	LOAD CAP.	W	D	H	WT.	PRICE
With Stringer						
MT-3060□	3,800	60	30	1 3/4	95	\$538.00
MT-3072□	3,600	72	30	1 3/4	113	639.00
MT-3096*	4,000	96	30	1 3/4	141	871.00
MT-3660□	3,800	60	36	1 3/4	105	634.00
MT-3672□	3,600	72	36	1 3/4	130	745.00
MT-3696*	4,000	96	36	1 3/4	169	1,300.00
Without Stringer						
G-MT-3060□	3,800	60	30	1 3/4	87	509.00
G-MT-3072□	3,600	72	30	1 3/4	103	605.00
G-MT-3096*	4,000	96	30	1 3/4	128	817.00
G-MT-3660□	3,800	60	36	1 3/4	97	605.00
G-MT-3672□	3,600	72	36	1 3/4	120	711.00
G-MT-3696*	4,000	96	36	1 3/4	156	1,246.00

Standard Colors (Unless Otherwise Specified)



♣ □
Items with these symbols are available to ship in 2-3 days. Limited quantities and select colors.

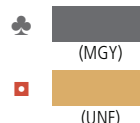

Workbench Tops

PLASTIC LAMINATE TOPS

CAT. NO.	LOAD CAP.	W	D	H	WT.	PRICE
With Stringer						
PT-3060 ◀	800	60	30	1 1/2	94	\$375.00
PT-3072 ◀	750	72	30	1 1/2	110	441.00
PT-3096*	1,200	96	30	1 1/2	147	627.00
PT-3660 ◀	800	60	36	1 1/2	118	488.00
PT-3672 ◀	750	72	36	1 1/2	150	513.00
PT-3696*	1,200	96	36	1 1/2	177	723.00
Without Stringer						
G-PT-3060 ◀	800	60	30	1 1/2	83	346.00
G-PT-3072 ◀	750	72	30	1 1/2	100	407.00
G-PT-3096*	1,200	96	30	1 1/2	134	573.00
G-PT-3660 ◀	800	60	36	1 1/2	110	459.00
G-PT-3672 ◀	750	72	36	1 1/2	140	479.00
G-PT-3696*	1,200	96	36	1 1/2	164	669.00

Available in White only.

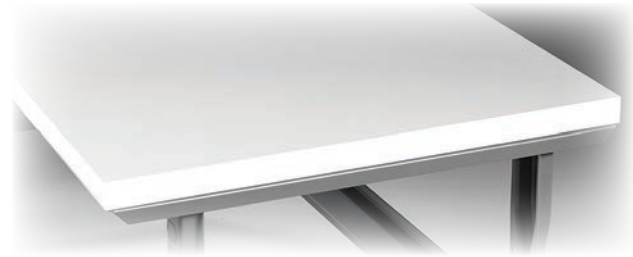

*96" w tops require three legs.
High pressure laminate top & edges; particleboard core.
Non-conductive surface is ideal for electronics.

Stringer required for workbenches with legs & no pedestals.

National Motor Freight Class: 70

COMPRESSED WOOD TOPS

CAT. NO.	LOAD CAP.	W	D	H	WT.	PRICE
With Stringer						
CT-3060 ◻	1,900	60	30	1 3/4	123	\$393.00
CT-3072 ◻	1,500	72	30	1 3/4	146	457.00
CT-3096*	2,400	96	30	1 3/4	185	750.00
CT-3660 ◻	1,900	60	36	1 3/4	137	477.00
CT-3672 ◻	1,500	72	36	1 3/4	174	544.00
CT-3696*	2,400	96	36	1 3/4	222	761.00
Without Stringer						
G-CT-3060 ◻	1,900	60	30	1 3/4	115	364.00
G-CT-3072 ◻	1,500	72	30	1 3/4	136	423.00
G-CT-3096*	2,400	96	30	1 3/4	172	696.00
G-CT-3660 ◻	1,900	60	36	1 3/4	129	448.00
G-CT-3672 ◻	1,500	72	36	1 3/4	164	510.00
G-CT-3696*	2,400	96	36	1 3/4	209	707.00

Available in Natural only.

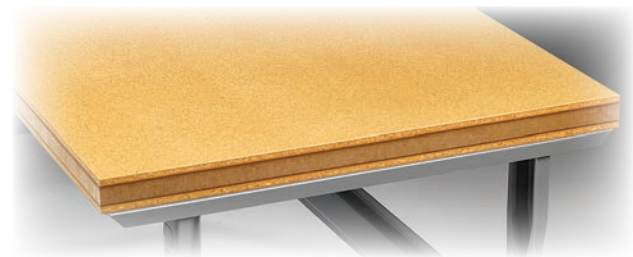

*96" w tops require three legs.
Tempered hardboard top and bottom surface laminated to compressed wood core. Banded on all sides with hard maple.

Stringer required for workbenches with legs & no pedestals.

National Motor Freight Class: 70

STRINGERS

CAT. NO.	W	D	H	WT.	PRICE
WBS-48 ♣	48	—	5	6.4	\$27.00
WBS-60 ♣	60	—	5	8.1	29.00
WBS-72 ♣	72	—	5	9.7	34.00
WBS-96 ♣	96	—	5	13.2	54.00

Ties workbench legs together for added stability.

Stiffening beads provide added strength.



National Motor Freight Class: 70

MOUNTING CHANNELS

CAT. NO.	W	D	H	WT.	PRICE
WBMC-30 ♣	1 3/16	30	1 5/16	4.2	\$22.00
WBMC-36 ♣	1 3/16	36	1 5/16	5.0	26.00

Mounts stackable drawer or modular cabinets on steel tops. Two mounting channels are included with steel top; order additional channels for unique configurations only.

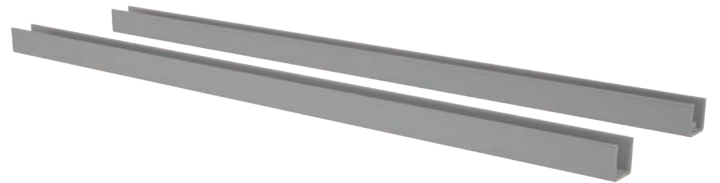

National Motor Freight Class: 70

MOUNTING ANGLES

CAT. NO.	W	D	H	WT.	PRICE
WBLB-30	1 7/8	22	1 1/16	3.4	\$17.90

Mounts stackable drawer on electronic workbench. One set required per hanging item.

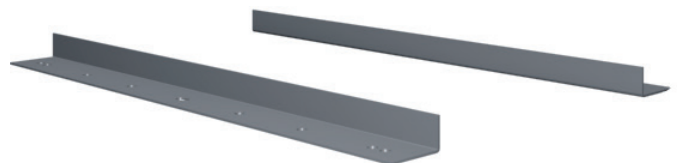

National Motor Freight Class: 70

Standard Colors (Unless Otherwise Specified)



Items with these symbols are available to ship in 2-3 days. Limited quantities and select colors.



FLARED LEGS



Priced per leg.
Complete with two easily removable plastic outlet inserts. Feet prepunched for floor anchoring.

24" deep legs available in quantity; consult factory for pricing.

National Motor Freight Class: 70

CAT. NO.	LOAD CAP.*	W	D	H	WT.	PRICE
L-2830	5,000	3 1/2	30	28	14.5	\$72.00
L-2836	5,000	3 1/2	36	28	15.5	74.00
L-3230♣	5,000	3 1/2	30	32	14.5	59.00
L-3236♣	5,000	3 1/2	36	32	16.0	64.00

*Load Capacity represents total per pair.

ADJUSTABLE LEGS



Priced per leg.

Complete with two easily removable plastic outlet inserts. Feet prepunched for floor anchoring.

National Motor Freight Class: 70

CAT. NO.	LOAD CAP.*	W	D	H**	WT.	PRICE
AL-3230♣	4,000	3	30	27 7/8-35 3/8	17.8	\$66.00
AL-3236♣	4,000	3	36	27 7/8-35 3/8	19.3	71.00
AL-4230♣	3,000	3	30	35 3/8-41 3/8	18.8	80.00
AL-4236♣	3,000	3	36	35 3/8-41 3/8	20.3	86.00

*Load Capacity represents total per pair.

**Adjustable on 1 1/2" centers.

PANEL LEGS



Priced per pair.
Prepunched holes for easy attachment.

National Motor Freight Class: 70

CAT. NO.	LOAD CAP.*	W	D	H	WT.	PRICE
LP-3230♣	2,000	3	28	32	48.0	\$199.00

*Load Capacity represents total per pair.

CASTER KITS



Casters attach to 30" or 36" deep flared or adjustable legs to provide mobility for your workbench. Kit includes mounting brackets and four casters, swivel and fixed. The swivel casters are lockable.

National Motor Freight Class: 70

CAT. NO.	LOAD CAP.	DESCRIPTION	WT.	PRICE
For 48"W - 72"W Workbenches				
WBCK-3036♣	1,000	Two fixed, Two swivel	16	\$98.00
WBCK-3036S	1,000	Four swivel	16	102.00
For 96"W Workbenches				
WBCK-3036-3	1,000	Two fixed, Four swivel	24	147.00

NOTE: Lower shelf or two stringers required for stability when using caster kits.

LOWER SHELVES

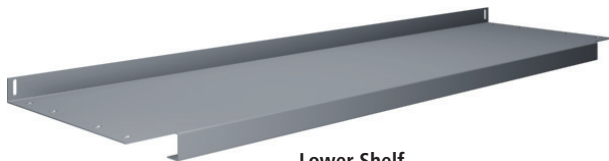

Lower Shelf

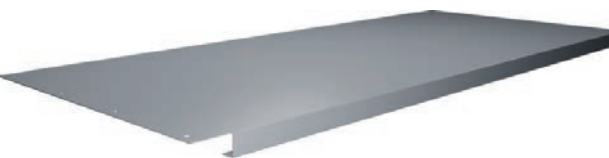

Full Depth Lower Shelf

National Motor Freight Class: 70

CAT. NO.	LOAD CAP.*	W	D	WT.	PRICE
Shelf For Flared Leg or Adjustable Leg Workbenches					
S-48♣	450	48	14	15.5	\$59.00
S-60♣	450	60	14	19.5	71.00
S-72♣	350	72	14	23.0	85.00
S-96♣	850	96	14	31.0	113.00
Full Depth Shelf For Flared Leg Workbenches					
FS-48	450	48	20	21.0	107.00
FS-60	450	60	20	25.0	119.00
FS-72	350	72	20	30.0	137.00
FS-96**	850	96	20	42.0	217.00
Full Depth Shelf For 30"D Adjustable Leg Workbenches					
FS-3060	450	60	20 1/2	36.0	97.00
FS-3072	450	72	20 1/2	41.0	113.00
Full Depth Shelf For 36"D Adjustable Leg Workbenches					
FS-3648	450	48	26 1/2	37.0	107.00
FS-3660	450	60	26 1/2	39.0	114.00
FS-3672	350	72	26 1/2	46.0	133.00
FS-3696**	850	96	26 1/2	60.0	174.00

*All loads must be evenly distributed.

**96"w are two pieces.

Standard Colors



Items with this symbol are available to ship in 2-3 days. Limited quantities and select colors.



(MGY)

Workbench Accessories

NOTE: Load capacities for Modular Storage Cabinets and Modular Drawer Cabinets represent units when being used to support a workbench with weight evenly distributed on top. Drawer load capacity is 70 lbs.

MODULAR CABINETS

CAT. NO.	LOAD CAP.	W	D	H	WT.	PRICE
Modular Cabinets						
MS-1524♣	1,000	15	24	32	48	\$304.00
MD-1524♣	1,000	15	24	32	77	578.00
MD2-1524	1,000	15	24	32	68	601.00
MD3-1524♣	1,000	15	24	32	69	605.00
Caster Kit For Modular Cabinets						
CB-1524	1,000	15	24	3 1/4	18	112.00
Extra Drawer Divider (Galvanized Only)						
WBDD-12♣		12 3/8	—	4 1/4	0.6	1.90
Optional Extra Shelf for MS-1524						
MBS-1524	100	15	23	3/4	5	44.00

Storage Cabinet comes standard with locking recessed handle. One adjustable shelf included. Drawer unit comes standard with keylock which locks all drawers simultaneously. Includes one divider per drawer. The MD-1524 & MD3-1524 come with one plastic pencil tray placed in the top drawer. Order tops without stringers with the modular units.



National Motor Freight Class: Cabinets, 100; Caster Kits, 70

CAT. NO.	LOAD CAP.	W	D	H	WT.	PRICE
WBHC-1516	70	15	18	16	20	\$185.00

National Motor Freight Class: 100

Cabinet comes standard with locking recessed handle. Can also be mounted under or above stackable drawer.

HANGING CABINET

Bolt-in center shelf can be flipped so cabinet door can open in either direction.

When mounting to steel top, use one set of Mounting Channels (included with top); when mounting to electronic workbench, use one set of Mounting Angles. Mounts to wood tops directly.



CAT. NO.	LOAD CAP.	W	D	H	WT.	PRICE
Stackable Drawer						
WBD-1	70	15	18	8 1/4	18	\$163.00
WBD-1-MGY*♣	70	15	18	8 1/4	21	91.00
Cam Lock (Field Installable)						
CL-1♣		—	—	—	0.1	6.30
Extra Divider (Galvanized Only)						
WBDD-12♣		12 3/8	—	4 1/4	0.6	1.90

*Medium Grey Only.

WBD-1 available only in select colors.

Includes one drawer divider, one removable pencil tray, and installed cam lock with key.

When mounting to steel top, use one set of Mounting Channels (included with top); when mounting to electronic workbench, use one set of Mounting Angles. Mounts to wood tops directly.

STACKABLE DRAWERS



National Motor Freight Class: 70

CAT. NO.	LOAD CAP.	W	D	H	WT.	PRICE
WBD-25	70	25	22	6	17	\$168.00

Includes left and right mounting channels, rear brace and drawer. Drawer includes cam lock.

25" WIDE HANGING DRAWER

When mounting to steel top, use one set of Mounting Channels (included with top); when mounting to electronic workbench, use one set of Mounting Angles (WBLB-30). Mounts to wood tops directly.



National Motor Freight Class: 70

CAT. NO.	LOAD CAP.	W	D	H	WT.	PRICE
SM-42	250	42	14	1 1/2	14.4	\$64.00

16 gauge steel shelf.

National Motor Freight Class: 70

MODULAR BENCH LOWER SHELF

For use with workbenches with modular units with 72"W tops.



CAT. NO.	W	D	H	WT.	PRICE
SB-3048♣	48	30	3	12.2	\$52.00
SB-3060♣	60	30	3	14.0	55.00
SB-3072♣	72	30	3	15.7	60.00
SB-3096♣	96	30	3	18.9	79.00
SB-3648	48	36	3	13.9	57.00
SB-3660	60	36	3	15.2	59.00
SB-3672♣	72	36	3	17.0	63.00
SB-3696♣	96	36	3	19.9	81.00

SIDE & BACK RAIL KITS



Adds 3" to overall workbench height.

National Motor Freight Class: 70

Standard Colors (Unless Otherwise Specified)



♣ Items with these symbols are available to ship in 2-3 days. Limited quantities and select colors.



WORKBENCH RISER WITH END SUPPORTS



Risers have a 1 1/2" tall backstop. Riser will add 12" overall height to the workbench. May be double stacked.

National Motor Freight Class: 70

CAT. NO.	LOAD CAP.	W	D	H	WT.	PRICE
R-1048♣	600	48	10 1/2	12	18.5	\$82.00
R-1060♣	450	60	10 1/2	12	21	\$89.00
R-1072♣	350	72	10 1/2	12	24	\$98.00
R-1096*♣	1,000	96	10 1/2	12	32	\$155.00
R-106018♣	450	60	10 1/2	18	24	\$114.00
R-107218♣	350	72	10 1/2	18	27	\$125.00

*96" w risers use a center upright.

ELECTRIC RISER WITH END SUPPORTS



Risers have a 1 1/2" tall backstop. Riser will add 12" or 18" overall height to the workbench.

Includes knockouts for four duplex receptacle outlets. Optional wiring kit may be ordered on page 71 or prewired below. May be double stacked.

National Motor Freight Class: 70

CAT. NO.	LOAD CAP.	W	D	H	WT.	PRICE
RE-1060♣	450	60	10 1/2	12	27	\$125.00
RE-1072♣	350	72	10 1/2	12	31	\$134.00
RE-1560	450	60	15	12	35	\$160.00
RE-1572	350	72	15	12	39	\$172.00
RE-18-1560♣	450	60	15	18	38	\$166.00
RE-18-1572♣	350	72	15	18	43	\$177.00
RE-18-1596♣	300	96	15	18	53	\$221.00

PREWIRED ELECTRIC RISER WITH END SUPPORTS



Risers have a 1 1/2" tall backstop. Riser will add 12" or 18" overall height to the workbench. May be double stacked.

National Motor Freight Class: 70

CAT. NO.	LOAD CAP.	W	D	H	WT.	PRICE
REI-1060-WK-1	450	60	10 1/2	12	30	\$334.00
REI-1072-WK-1	350	72	10 1/2	12	34	\$345.00
REI-1560-WK-1	450	60	15	12	35	\$362.00
REI-1572-WK-1	350	72	15	12	53	\$380.00
REI-18-1560-WK-1♣	450	60	15	18	54	\$374.00
REI-18-1572-WK-1♣	350	72	15	18	60	\$392.00
REI-18-1596-WK-1	300	96	15	18	72	\$444.00

DOUBLE DECKER CENTER RISER WITH END SUPPORTS

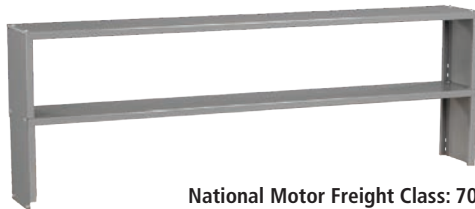

National Motor Freight Class: 70

CAT. NO.	LOAD CAP.	W	D	H	WT.	PRICE
R2-1060	450	60	10 1/2	24	42	\$189.00
R2-1072	350	72	10 1/2	24	48	\$209.00

Risers have no back flanges. Unit may be mounted in center of top for double entry.

ELECTRIC OUTLET PANEL FOR BENCHES WITH PANEL LEGS



National Motor Freight Class: 70

CAT. NO.	W	D	H	WT.	PRICE
WOP-72♣	71 5/8	3	4 3/8	17.4	\$122.00

Provides mounting plate for four duplex outlets on 72" panel leg workbenches. Optional wiring kit is available on page 71.

ELECTRIC OUTLET PANEL FOR BENCHES WITH TWO MODULAR UNITS



National Motor Freight Class: 70

CAT. NO.	W	D	H	WT.	PRICE
Without Wiring Kit					
WOP-42♣	42	3 3/8	4 3/8	10.3	\$64.00
Wiring Kit Installed					
WOPI-42-WK-1	42	3 3/8	4 3/8	12.8	\$238.00

Provides mounting plate for four duplex outlets on panel leg workbenches. Optional wiring kit is available on page 71.

Standard Colors (Unless Otherwise Specified)



Items with this symbol are available to ship in 2-3 days. Limited quantities and select colors.



(MGY)

Workbench Accessories

WIRING KIT

CAT. NO.	WT.	PRICE
WK-1 	2.5	\$132.00

Prewired for quick installation. Comes complete with four duplex receptacles, on/off switch with pilot light, 8 foot grounded cord and plug, 15 amp, 115 volt service and circuit breaker. Use with electronic riser, outlet panels, or electronic workbench.

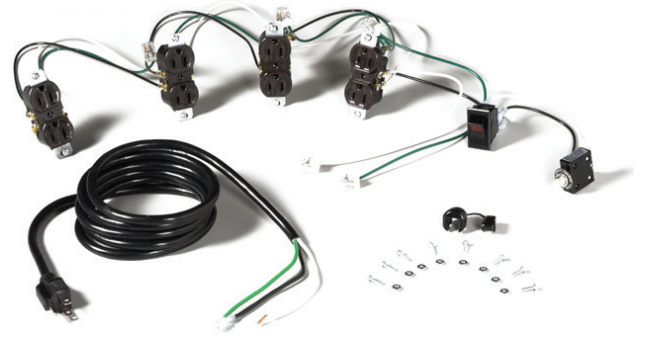

National Motor Freight Class: 70



**SR-57
OPEN STYLE**





**SR-58
CLOSED STYLE**



**SR-59
WALL MOUNTED**

FOREMAN'S DESKS

CAT. NO.	W	D	H	LOAD CAPACITY			WT.	PRICE
				TOP	DRAWER	SHELF		
SR-57 	34 1/2	29	53	Open Style			97	\$591.00
SR-58 	34 1/2	29	53	Closed Style			155	942.00
SR-59 	34 1/2	29	17 1/2*	Wall Mounted			83	601.00



*Note: If including mounting bracket in height calculations, add 16 1/4" to height listed above.
Combines a convenient, sturdy writing surface with compartmentalized riser for storing writing utensils, forms and papers. Drawer comes standard with lock and two keys. Shipped partially assembled.

Medium Grey only. National Motor Freight Class: 70

Standard Colors



Medium Grey (MGY)

  
Items with these symbols are available to ship in 2-3 days. Limited quantities and select colors.

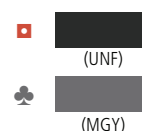

CANTILEVERED ACCESSORY SYSTEM

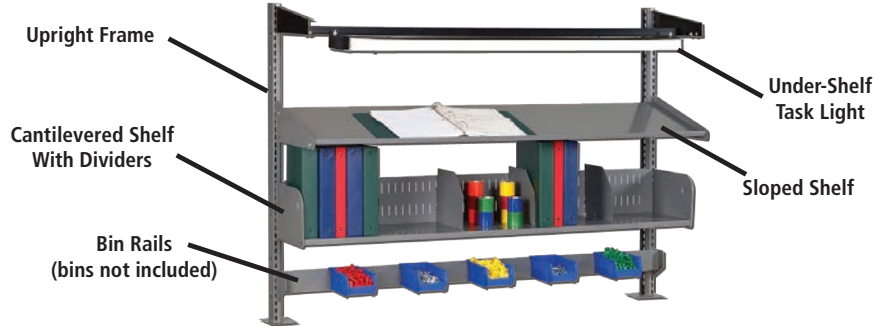

The Cantilevered Accessory System provides a variety of convenient storage options for your workstation. Start with upright frames, then add accessories such as shelves with dividers, sloped shelves, an overhead light, or a bin rail for adding third-party bins for small parts storage.

UPRIGHT FRAMES



Accessories attach to uprights without tools.

NOTE: Cantilever system requires 72" or wider top.

National Motor Freight Class: 70

CAT. NO.	DESCRIPTION	W	D	H	WT.	PRICE
WBRU-24A	Sold as a Pair	4	5 1/4	24	10.7	\$83.00
WBRU-42A	Sold as a Pair	4	5 1/4	42	15.7	\$85.00

Upright frames attach to the rear edge of the work surface to provide a substantial structure from which to support storage shelves, bin rails, sloped shelves and lighting. Attaches with four bolts per side (drilling required to attach). Both sizes of uprights may be attached directly to the Tensco steel or wood tops.

CANTILEVERED SHELF

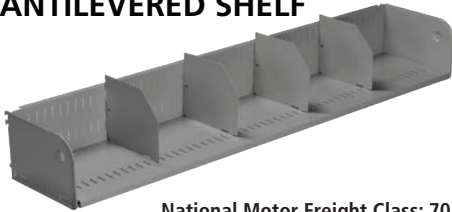

National Motor Freight Class: 70

CAT. NO.	W	D	H	WT.	PRICE
TWBS-6012A	60	12	7 1/2	21	\$81.00

May be quickly and easily repositioned. Four adjustable dividers are furnished with each shelf.

SLOPED SHELF

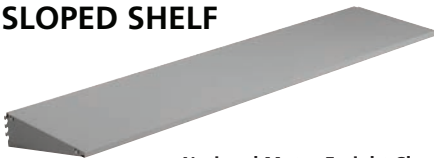

National Motor Freight Class: 70

CAT. NO.	W	D	H	WT.	PRICE
TWSS-6012A	60	12	3/4	19	\$59.00

May be quickly and easily repositioned. Includes a front lip to keep items from rolling off the shelf.

BIN RAIL

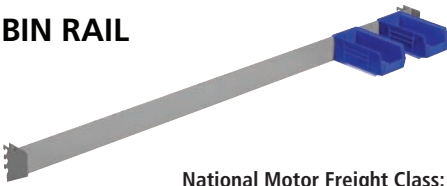

National Motor Freight Class: 70

CAT. NO.	W	D	H	WT.	PRICE
TWBR-60	60	3 7/8	4 3/16	7	\$116.00

Bin Rails accommodate a variety of commercially available plastic and steel parts bins. Easily adjustable up or down on the upright frame. Bins not included.

CANTILEVER TASK LIGHTING



National Motor Freight Class: 70

CAT. NO.	W	D	H	WT.	PRICE
TWCTL-48	Task Light			14	\$199.00
	50 5/32	8	1 25/32		
TWLB-60	Light Bracket Kit			8.2	\$52.00
	60	13 1/2	3 1/2		

The cantilever task light provides overhead lighting for your work area. Unit contains two 32-watt lamps and is prewired with an 8' power cord and power switch. Use bracket kit for mounting onto cantilever uprights. Mounting bracket allows light to adjust back and forth in 1 1/2" increments, or an angle if mounted on top. Available in black only.

Standard Colors (Unless Otherwise Specified)



Mobile Workbenches & Service Carts

MOBILE WORKBENCHES



MB-1-2542



MB-2530-BB



MB-3-2545



MB-4-2545



MB-2-2542



MB-2530-C



MB-5-2545



MB-6-2545



MB-7-2545



REI-1045-WK-1



MHE-25

CAT. NO.	LOAD CAP.	W	D	H	WT.	PRICE
Mobile Workbenches						
*MB-1-2542♣	1,000	42	25	36 1/4	182	\$1,283.00
*MB-2-2542♣	1,000	42	25	36 1/4	157	1,022.00
**MB-2530-BB♣	1,000	33	25	40	234	1,294.00
**MB-2530-C♣	1,000	33	25	40	153	831.00
**MB-3-2545♣	1,000	48	25	40	294	1,898.00
**MB-4-2545♣	1,000	48	25	40	270	1,570.00
**MB-5-2545	1,000	48	25	40	220	1,453.00
**MB-6-2545	1,000	48	25	40	251	1,442.00
**MB-7-2545	1,000	48	25	40	278	1,663.00
Extra Shelf For Cabinet of MB-1-2542 or MB-2-2542						
MBS-2124	100	21	23	3/4	6.4	50.00
Extra Shelf For Left Side of MB-2-2542 or 15" Wide Single Door Cabinets						
MBS-1524	100	15	23	3/4	5.0	44.00
Prewired Electric Riser (Fits only 48" wide units)						
REI-1045-WK-1	—	45	8	10 1/4	23.0	224.00
Electric Riser (Fits only 48" wide units)						
RE-1045*	—	45	8	10 1/4	23.0	116.00
Push Handle Power Strip						
MHE-25	—	25	8	10 1/4	5.0	196.00

*Side and Back Rail adds 1 3/4" to overall workbench height.

**Side and Back Rail on the 3" to overall workbench height.

*Optional wiring kit (WK-1) may be ordered on page 71.

National Motor Freight Class: 100

SERVICE CARTS

CAT. NO.	LOAD CAP.	W	D	H	WT.	PRICE
16" Wide Service Cart						
SC-1630♣	150*	30	16	32	36	\$203.00
Optional Center Tray For 16" Wide Service Cart						
ST-16♣	150	30	16	3 1/4	11	61.00
24" Wide Service Cart						
SC-2436♣	150*	36	24	32	40	254.00
Optional Center Tray For 24" Wide Service Cart						
ST-24♣	150	36	24	3 1/4	15.8	80.00

*Load capacity is 150 lbs. per tray.

Two-shelf service cart with optional center tray. Trays have 3/8" lip and can be reversed to use as either a flat work surface or a storage compartment. Hard rubber casters (two swivel and two stationary). Shipped unassembled.

National Motor Freight Class: 70



Available in Medium Grey only.

SHOP EQUIPMENT

Standard Colors (Unless Otherwise Specified)



♣ Items with these symbols are available to ship in 2-3 days. Limited quantities and select colors.



TECHNICAL WORKSTATIONS WITH FIXED LEGS



TW-603630NE



TW-603630S

CAT. NO.	W	D	H	WT.	PRICE
Standard Work Surface					
TW-603030-N	60	30	30	121	\$890.00
TW-603034-N	60	30	34	124	\$898.00
TW-603630-N	60	36	30	127	\$964.00
TW-603634-N	60	36	34	131	\$972.00
TW-723030-N	72	30	30	132	\$957.00
TW-723034-N	72	30	34	135	\$965.00
TW-723630-N	72	36	30	152	\$1,074.00
TW-723634-N	72	36	34	156	\$1,082.00
Standard Work Surface With Power Rail					
TW-603030-NE	60	30	30	124	\$1,087.00
TW-603034-NE	60	30	34	127	\$1,095.00
TW-603630-NE	60	36	30	130	\$1,161.00
TW-603634-NE	60	36	34	134	\$1,169.00
TW-723030-NE	72	30	30	137	\$1,139.00
TW-723034-NE	72	30	34	140	\$1,147.00
TW-723630-NE	72	36	30	157	\$1,256.00
TW-723634-NE	72	36	34	161	\$1,264.00

CAT. NO.	W	D	H	WT.	PRICE
Static Control Work Surface					
TW-603030-S	60	30	30	121	\$1,125.00
TW-603034-S	60	30	34	124	\$1,133.00
TW-603630-S	60	36	30	127	\$1,151.00
TW-603634-S	60	36	34	131	\$1,159.00
TW-723030-S	72	30	30	132	\$1,200.00
TW-723034-S	72	30	34	135	\$1,208.00
TW-723630-S	72	36	30	152	\$1,330.00
TW-723634-S	72	36	34	156	\$1,338.00
Static Control Work Surface With Power Rail					
TW-603030-SE	60	30	30	124	\$1,322.00
TW-603034-SE	60	30	34	127	\$1,330.00
TW-603630-SE	60	36	30	130	\$1,348.00
TW-603634-SE	60	36	34	134	\$1,356.00
TW-723030-SE	72	30	30	137	\$1,382.00
TW-723034-SE	72	30	34	140	\$1,390.00
TW-723630-SE	72	36	30	157	\$1,512.00
TW-723634-SE	72	36	34	161	\$1,520.00

Standard Work Surface: A plastic-laminate top, trimmed with PVC edging.

Static Control Work Surface: A plastic-laminate top, trimmed with oak edging. Rated at 10⁶-10⁹ ohms per sq. centimeter. Grounding cables not provided.

National Motor Freight Class: 70

TECHNICAL WORKSTATIONS WITH ADJUSTABLE LEGS



TW-603630NA



TW-603630SEA

CAT. NO.	W	D	H	WT.	PRICE
Standard Work Surface					
TW-603030-NA	60	30	30-36	123	\$946.00
TW-603034-NA	60	30	34-40	131	\$961.00
TW-603630-NA	60	36	30-36	132	\$1,013.00
TW-603634-NA	60	36	34-40	138	\$1,028.00
TW-723030-NA	72	30	30-36	134	\$1,013.00
TW-723034-NA	72	30	34-40	142	\$1,028.00
TW-723630-NA	72	36	30-36	152	\$1,123.00
TW-723634-NA	72	36	34-40	163	\$1,138.00
Standard Work Surface With Power Rail					
TW-603030-NEA	60	30	30-36	126	\$1,143.00
TW-603034-NEA	60	30	34-40	134	\$1,158.00
TW-603630-NEA	60	36	30-36	130	\$1,161.00
TW-603634-NEA	60	36	34-40	141	\$1,225.00
TW-723030-NEA	72	30	30-36	139	\$1,195.00
TW-723034-NEA	72	30	34-40	147	\$1,210.00
TW-723630-NEA	72	36	30-36	162	\$1,305.00
TW-723634-NEA	72	36	34-40	149	\$1,320.00

CAT. NO.	W	D	H	WT.	PRICE
Static Control Work Surface					
TW-603030-SA	60	30	30-36	123	\$1,181.00
TW-603034-SA	60	30	34-40	131	\$1,196.00
TW-603630-SA	60	36	30-36	132	\$1,200.00
TW-603634-SA	60	36	34-40	138	\$1,215.00
TW-723030-SA	72	30	30-36	134	\$1,256.00
TW-723034-SA	72	30	34-40	142	\$1,271.00
TW-723630-SA	72	36	30-36	157	\$1,379.00
TW-723634-SA	72	36	34-40	163	\$1,394.00
Static Control Work Surface With Power Rail					
TW-603030-SEA	60	30	30-36	126	\$1,378.00
TW-603034-SEA	60	30	34-40	134	\$1,393.00
TW-603630-SEA	60	36	30-36	135	\$1,397.00
TW-603634-SEA	60	36	34-40	141	\$1,412.00
TW-723030-SEA	72	30	30-36	139	\$1,438.00
TW-723034-SEA	72	30	34-40	147	\$1,453.00
TW-723630-SEA	72	36	30-36	162	\$1,561.00
TW-723634-SEA	72	36	34-40	168	\$1,576.00

Standard Work Surface: A plastic-laminate top, trimmed with PVC edging.

Static Control Work Surface: A plastic-laminate top, trimmed with oak edging. Rated at 10⁶-10⁹ ohms per sq. centimeter. Grounding cables not provided.

National Motor Freight Class: 70

Standard Colors



Sand (SND) Accent Blue (ABL)



TOP COLOR:
Almond (L004)

INSTRUMENT SHELVES

Standard Work Surface



Standard Work Surface With Power Rail



Static Control Work Surface



Static Control Work Surface With Power Rail



National Motor Freight Class: 70

CAT. NO.	W	D	H	WT.	PRICE
Standard Work Surface					
TWI-60-N	60	15	18	61	\$545.00
TWI-72-N	72	15	18	69	618.00

CAT. NO.	W	D	H	WT.	PRICE
Standard Work Surface With Power Rail					
TWI-60-NE	60	15	18	64	\$742.00
TWI-72-NE	72	15	18	74	800.00

CAT. NO.	W	D	H	WT.	PRICE
Static Control Work Surface					
TWI-60-S	60	15	18	61	\$666.00
TWI-72-S	72	15	18	69	745.00

CAT. NO.	W	D	H	WT.	PRICE
Static Control Work Surface With Power Rail					
TWI-60-SE	60	15	18	64	\$863.00
TWI-72-SE	72	15	18	74	927.00

HANGING DRAWER UNITS



PED-10-36



PED-30-36



PED-20-36

National Motor Freight Class: 70

CAT. NO.	DESCRIPTION	W	D	H	WT.	PRICE
1 Drawer Units						
PED-10-30	Fits 30" Workstations	15	24	9	39	\$421.00
PED-10-36	Fits 36" Workstations	15	24	9	39	425.00
2 Drawer Units						
PED-20-30	Fits 30" Workstations	15	24	20 3/4	66	630.00
PED-20-36	Fits 36" Workstations	15	24	20 3/4	66	634.00
3 Drawer Units						
PED-30-30	Fits 30" Workstations	15	24	20 3/4	76	726.00
PED-30-36	Fits 36" Workstations	15	24	20 3/4	76	730.00

Standard Colors



Sand (SND) Accent Blue (ABL)

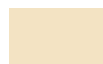

TOP COLOR: Almond (L004)

WORKSTATION TOPS



Almond Color Only.

National Motor Freight Class: 70

CAT. NO.	W	D	H	WT.	PRICE
Standard Work Surface					
TWST-6030	60	30	1	65	\$429.00
TWST-6036	60	36	1	70	492.00
TWST-7230	72	30	1	73	497.00
TWST-7236	72	36	1	92	603.00
Static Control Work Surface					
TWDT-6030	60	30	1	65	664.00
TWDT-6036	60	36	1	70	679.00
TWDT-7230	72	30	1	73	740.00
TWDT-7236	72	36	1	92	859.00

TOP MOUNTED POWER RAILS



National Motor Freight Class: 70

CAT. NO.	W	D	H	WT.	PRICE
TWP-60	54	2 1/2	1 3/4	12	\$288.00
TWP-72	66	2 1/2	1 3/4	14	288.00



WORKSTATION GROUNDING KIT



National Motor Freight Class: 70

CAT. NO.	W	D	H	WT.	PRICE
TWG-20	—	—	—	1	\$34.00



TASK LIGHT FOR INSTRUMENT SHELVES



National Motor Freight Class: 70

CAT. NO.	DESCRIPTION	W	D	H	WT.	PRICE
TWCTL-48	Task Light	50 5/32	8	1 25/32	14	\$199.00

Task light has two 32-watt lamps.



Task light mounts underneath instrument shelves.

Standard Colors

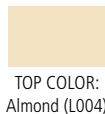
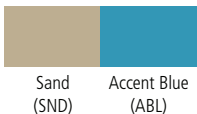

UPRIGHT FRAMES

CAT. NO.	W	D	H	WT.	PRICE
TWRU-24A	4	5 1/4	24	9.7	\$60.00
TWRU-42A	4	5 1/4	42	15.7	75.00

Sold as pairs.

NOTE: Benchtops less than 60" wide can not accommodate the Cantilever Accessory System.



National Motor Freight Class: 70

CANTILEVERED SHELF

CAT. NO.	W	D	H	WT.	PRICE
TWBS-6012A	60	12	7 1/4	21	\$81.00

Includes four dividers, adjustable on 1" centers.



National Motor Freight Class: 70

SLOPED SHELF

CAT. NO.	W	D	H	WT.	PRICE
TWSS-6015A	60	15	3/4	18.6	\$73.00



National Motor Freight Class: 70

Standard Colors

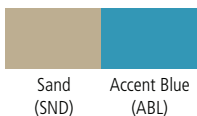

BIN RAIL



National Motor Freight Class: 70

CAT. NO.	W	D	H	WT.	PRICE
TWBR-60	60	3 7/8	4 3/16	7	\$116.00

CANOPY TOP

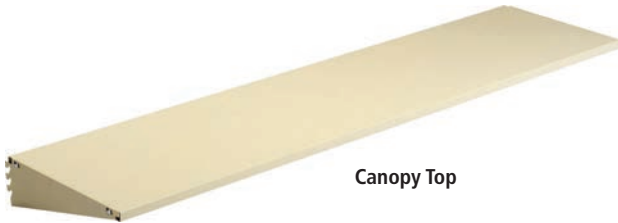

Canopy Top

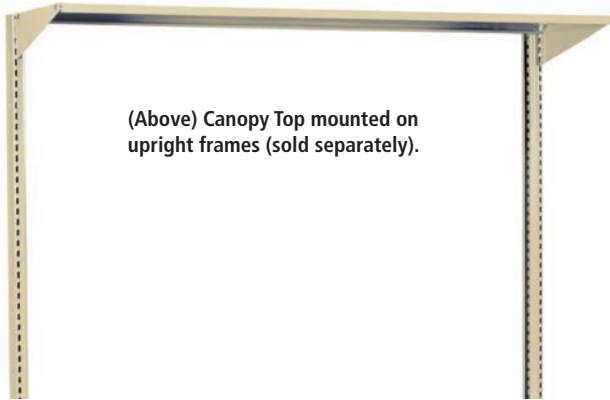

(Above) Canopy Top mounted on upright frames (sold separately).

National Motor Freight Class: 70

CAT. NO.	W	D	H	WT.	PRICE
TWCT-6014	60	15	3/4	13.5	\$52.00

CANTILEVER TASK LIGHTING



Task Light



Task Light with Light Bracket Kit

National Motor Freight Class: 70

CAT. NO.	DESCRIPTION	W	D	H	WT.	PRICE
TWCTL-48	Task Light	50 5/32	8	1 25/32	14	\$199.00
TWLB-60	Light Bracket Kit	60	13 1/2	3 1/2	8.2	\$2.00

Task light has two 32-watt lamps.

Light Bracket Kit is Black only.

Standard Colors

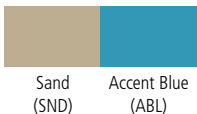

L&T SHELVING SYSTEM

Tennsco L&T systems use a unique interlock design to combine strength and rigidity for extra functional flexibility and assembly ease. It snaps together in minutes for quick installation and reconfiguration whenever necessary.

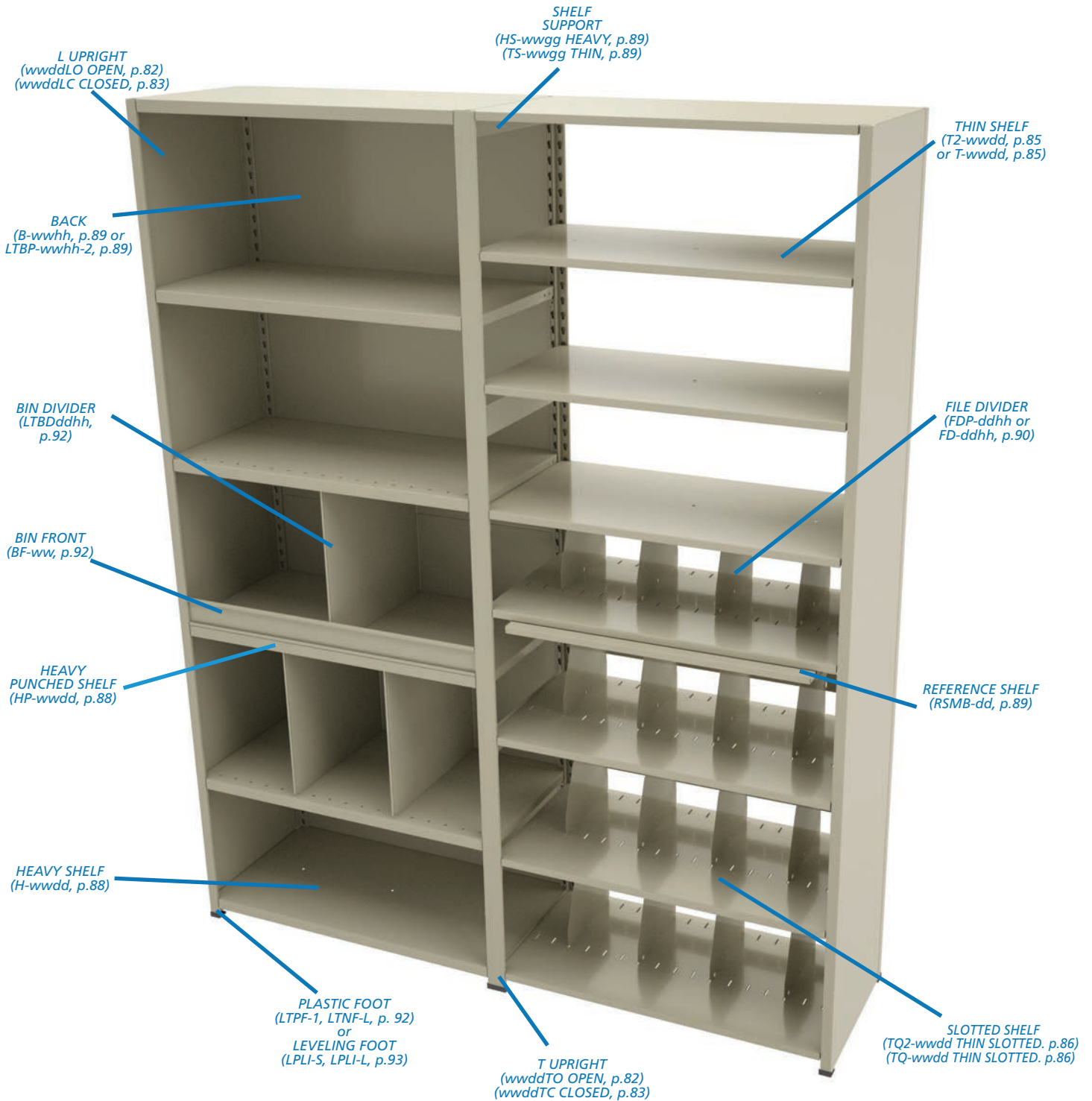

L&T shelving offers a vast array of shelf accessories which can be easily added to any L&T unit.

For L&T Colors [click here](#)
OR
call customer service at: (866) 446-8686

L&T Preconfigured Units - 76" High

8 SHELVES, 7 OPENINGS

- Includes: Uprights (Two Closed "L" for Starter Units)
OR (One Open "T" for Adder Units)
Slotted steel shelves (22 gauge)
Plain top shelf (22 gauge)
Shelf supports
Reinforcements (where noted)
Backstops or centerstops
Adjustable dividers
Front base(s)
Optional back available on page 90

STARTER UNITS

ADDER UNITS



Height to top of bottom shelf: 3"; shelf spaced 10 1/2" on center with 9 3/4" vertical filing space/opening.

UNIT SIZE			REINFORCEMENTS PER LEVEL	SHELF LOAD CAPACITY	NO. OF DIVIDERS/ OPENINGS	TOTAL FILING INCHES	STARTER UNITS			ADDER UNITS		
W	D	H					CAT NO.	WT.	PRICE	CAT NO.	WT.	PRICE
Single Entry												
30	12	76 1/4	—	600	4	196	LCT-8-3012-6	110	\$478.00	TOT-8-3012-6	97	\$419.00
36	12	76 1/4	—	600	4	238	LCT-8-3612-6	122	478.00	TOT-8-3612-6	109	419.00
42	12	76 1/4	—	600	4	280	LCT-8-4212-6	151	574.00	TOT-8-4212-6	138	515.00
48	12	76 1/4	—	550	5	322	LCT-8-4812-6	170	636.00	TOT-8-4812-6	157	577.00
30	15	76 1/4	—	500	4	196	LCT-8-3015-6	120	512.00	TOT-8-3015-6	104	442.00
36	15	76 1/4	—	500	4	238	LCT-8-3615-6	132	512.00	TOT-8-3615-6	116	442.00
42	15	76 1/4	—	500	4	280	LCT-8-4215-6	162	619.00	TOT-8-4215-6	146	549.00
48	15	76 1/4	—	400	5	322	LCT-8-4815-6	183	679.00	TOT-8-4815-6	167	609.00
Double Entry												
30	24	76 1/4	1	400	8	392	LCT-8-3024-6	187	778.00	TOT-8-3024-6	161	667.00
36	24	76 1/4	1	400	8	476	LCT-8-3624-6	205	778.00	TOT-8-3624-6	179	672.00
42	24	76 1/4	2	500	8	560	LCT-8-4224-6	247	908.00	TOT-8-4224-6	221	801.00
48	24	76 1/4	2	450	10	644	LCT-8-4824-6	278	1,014.00	TOT-8-4824-6	252	887.00
30	30	76 1/4	2	400	8	392	LCT-8-3030-6	217	898.00	TOT-8-3030-6	186	773.00
36	30	76 1/4	2	400	8	476	LCT-8-3630-6	239	898.00	TOT-8-3630-6	208	773.00
42	30	76 1/4	2	450	8	560	LCT-8-4230-6	275	1,007.00	TOT-8-4230-6	245	887.00
48	30	76 1/4	2	400	10	644	LCT-8-4830-6	310	1,129.00	TOT-8-4830-6	279	1,007.00

No reinforcements are used on the top shelf.

7 SHELVES, 6 OPENINGS

- Includes: Uprights (Two Closed "L" for Starter Units)
OR (One Open "T" for Adder Units)
Slotted steel shelves (22 gauge)
Plain top shelf (22 gauge)
Shelf supports
Reinforcements (where noted)
Backstops or centerstops
Adjustable dividers
Front base(s)
Optional back available on page 90

STARTER UNITS

ADDER UNITS



Height to top of bottom shelf: 4 1/2"; shelf spaced 12" on center with 11 1/4" vertical filing space/opening.

UNIT SIZE			REINFORCEMENTS PER LEVEL	SHELF LOAD CAPACITY	NO. OF DIVIDERS/ OPENINGS	TOTAL FILING INCHES	STARTER UNITS			ADDER UNITS		
W	D	H					CAT NO.	WT.	PRICE	CAT NO.	WT.	PRICE
Single Entry												
30	12	76 1/4	—	600	4	168	LCT-7-3012-6	100	\$434.00	TOT-7-3012-6	86	\$375.00
36	12	76 1/4	—	600	4	204	LCT-7-3612-6	111	434.00	TOT-7-3612-6	97	375.00
42	12	76 1/4	—	600	4	240	LCT-7-4212-6	136	519.00	TOT-7-4212-6	122	460.00
48	12	76 1/4	—	550	5	276	LCT-7-4812-6	152	573.00	TOT-7-4812-6	139	514.00
30	15	76 1/4	—	500	4	168	LCT-7-3015-6	109	465.00	TOT-7-3015-6	92	394.00
36	15	76 1/4	—	500	4	204	LCT-7-3615-6	120	465.00	TOT-7-3615-6	103	395.00
42	15	76 1/4	—	500	4	240	LCT-7-4215-6	146	559.00	TOT-7-4215-6	130	489.00
48	15	76 1/4	—	400	5	276	LCT-7-4815-6	164	612.00	TOT-7-4815-6	148	542.00
Double Entry												
30	24	76 1/4	1	400	8	336	LCT-7-3024-6	169	704.00	TOT-7-3024-6	143	594.00
36	24	76 1/4	1	400	8	408	LCT-7-3624-6	185	704.00	TOT-7-3624-6	159	598.00
42	24	76 1/4	2	500	8	480	LCT-7-4224-6	221	818.00	TOT-7-4224-6	195	711.00
48	24	76 1/4	2	450	10	552	LCT-7-4824-6	249	910.00	TOT-7-4824-6	223	800.00
30	30	76 1/4	2	400	8	336	LCT-7-3030-6	195	811.00	TOT-7-3030-6	165	686.00
36	30	76 1/4	2	400	8	408	LCT-7-3630-6	215	811.00	TOT-7-3630-6	184	691.00
42	30	76 1/4	2	450	8	480	LCT-7-4230-6	247	907.00	TOT-7-4230-6	216	787.00
48	30	76 1/4	2	400	10	552	LCT-7-4830-6	277	1,013.00	TOT-7-4830-6	246	891.00

No reinforcements are used on the top shelf.

For L&T Colors [click here](#)
OR
call customer service at: (866) 446-8686

Mobile Ready Units - Any unit can be converted by substituting an "M" for the final dash in the catalog number. Example: LCT-8-3012-6 becomes LCT-8-3012M6. Pricing is identical; weight may vary slightly

L&T Preconfigured Units - 88" High

- Includes: Uprights (Two Closed "L" for Starter Units)
 OR (One Open "T" for Adder Units)
 Slotted steel shelves (22 gauge)
 Plain top shelf (22 gauge)
 Shelf supports
 Reinforcements (where noted)
 Backstops or centerstops
 Adjustable dividers
 Front base(s)
 Optional back available on page 90

9 SHELVES, 8 OPENINGS

STARTER UNITS

ADDER UNITS



Height to top of bottom shelf: 4 1/2"; shelf spaced 10 1/2" on center with 9 3/4" vertical filing space/opening.

UNIT SIZE			REINFORCEMENTS PER LEVEL	SHELF LOAD CAPACITY	NO. OF DIVIDERS/ OPENINGS	TOTAL FILING INCHES	STARTER UNITS			ADDER UNITS		
W	D	H					CAT NO.	WT.	PRICE	CAT NO.	WT.	PRICE
Single Entry												
30	12	88 1/4	—	600	4	224	LCT-9-3012-7	126	\$546.00	TOT-9-3012-7	109	\$473.00
36	12	88 1/4	—	600	4	272	LCT-9-3612-7	140	546.00	TOT-9-3612-7	123	473.00
42	12	88 1/4	—	600	4	320	LCT-9-4212-7	172	655.00	TOT-9-4212-7	155	582.00
48	12	88 1/4	—	550	5	368	LCT-9-4812-7	152	724.00	TOT-9-4812-7	177	651.00
30	15	88 1/4	—	500	4	224	LCT-9-3015-7	136	590.00	TOT-9-3015-7	118	503.00
36	15	88 1/4	—	500	4	272	LCT-9-3615-7	150	590.00	TOT-9-3615-7	132	504.00
42	15	88 1/4	—	500	4	320	LCT-9-4215-7	184	711.00	TOT-9-4215-7	166	625.00
48	15	88 1/4	—	400	5	368	LCT-9-4815-7	208	779.00	TOT-9-4815-7	190	693.00
Double Entry												
30	24	88 1/4	1	400	8	448	LCT-9-3024-7	213	888.00	TOT-9-3024-7	183	762.00
36	24	88 1/4	1	400	8	544	LCT-9-3624-7	233	888.00	TOT-9-3624-7	203	767.00
42	24	88 1/4	2	500	8	640	LCT-9-4224-7	281	1,036.00	TOT-9-4224-7	251	915.00
48	24	88 1/4	2	450	10	736	LCT-9-4824-7	316	1,156.00	TOT-9-4824-7	286	1,035.00
30	30	88 1/4	2	400	8	448	LCT-9-3030-7	245	1,029.00	TOT-9-3030-7	212	878.00
36	30	88 1/4	2	400	8	544	LCT-9-3630-7	270	1,029.00	TOT-9-3630-7	237	883.00
42	30	88 1/4	2	450	8	640	LCT-9-4230-7	311	1,153.00	TOT-9-4230-7	278	1,005.00
48	30	88 1/4	2	400	10	736	LCT-9-4830-7	350	1,291.00	TOT-9-4830-7	317	1,145.00

No reinforcements are used on the top shelf.

- Includes: Uprights (Two Closed "L" for Starter Units)
 OR (One Open "T" for Adder Units)
 Slotted steel shelves (22 gauge)
 Plain top shelf (22 gauge)
 Shelf supports
 Reinforcements (where noted)
 Backstops or centerstops
 Adjustable dividers
 Front base(s)
 Optional back available on page 90

8 SHELVES, 7 OPENINGS

STARTER UNITS

ADDER UNITS

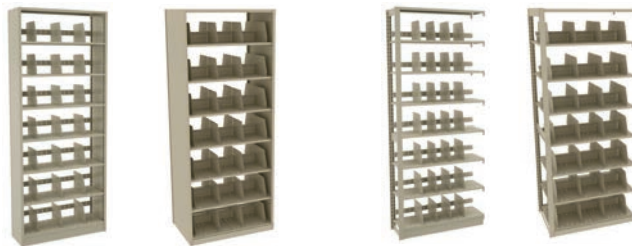

Height to top of bottom shelf: 4 1/2"; shelf spaced 12" on center with 11 1/4" vertical filing space/opening.

UNIT SIZE			REINFORCEMENTS PER LEVEL	SHELF LOAD CAPACITY	NO. OF DIVIDERS/ OPENINGS	TOTAL FILING INCHES	STARTER UNITS			ADDER UNITS		
W	D	H					CAT NO.	WT.	PRICE	CAT NO.	WT.	PRICE
Single Entry												
30	12	88 1/4	—	600	4	196	LCT-8-3012-7	115	\$500.00	TOT-8-3012-7	98	\$427.00
36	12	88 1/4	—	600	4	238	LCT-8-3612-7	128	500.00	TOT-8-3612-7	111	427.00
42	12	88 1/4	—	600	4	280	LCT-8-4212-7	156	597.00	TOT-8-4212-7	139	524.00
48	12	88 1/4	—	550	5	322	LCT-8-4812-7	175	658.00	TOT-8-4812-7	158	585.00
30	15	88 1/4	—	500	4	196	LCT-8-3015-7	124	542.00	TOT-8-3015-7	106	455.00
36	15	88 1/4	—	500	4	238	LCT-8-3615-7	137	542.00	TOT-8-3615-7	119	456.00
42	15	88 1/4	—	500	4	280	LCT-8-4215-7	167	649.00	TOT-8-4215-7	149	563.00
48	15	88 1/4	—	400	5	322	LCT-8-4815-7	188	709.00	TOT-8-4815-7	170	623.00
Double Entry												
30	24	88 1/4	1	400	8	392	LCT-8-3024-7	194	810.00	TOT-8-3024-7	164	684.00
36	24	88 1/4	1	400	8	476	LCT-8-3624-7	212	810.00	TOT-8-3624-7	182	689.00
42	24	88 1/4	2	500	8	560	LCT-8-4224-7	254	941.00	TOT-8-4224-7	224	820.00
48	24	88 1/4	2	450	10	644	LCT-8-4824-7	285	1,047.00	TOT-8-4824-7	255	921.00
30	30	88 1/4	2	400	8	392	LCT-8-3030-7	223	938.00	TOT-8-3030-7	190	788.00
36	30	88 1/4	2	400	8	476	LCT-8-3630-7	245	938.00	TOT-8-3630-7	249	792.00
42	30	88 1/4	2	450	8	560	LCT-8-4230-7	282	1,048.00	TOT-8-4230-7	278	902.00
48	30	88 1/4	2	400	10	644	LCT-8-4830-7	316	1,170.00	TOT-8-4830-7	283	1,024.00

No reinforcements are used on the top shelf.

For L&T Colors [click here](#)
 OR
 call customer service at: (866) 446-8686

Mobile Ready Units - Any unit can be converted by substituting an "M" for the final dash in the catalog number. Example: LCT-9-3012-7 becomes LCT-9-3012M7. Pricing is identical; weight may vary slightly

OPEN UPRIGHTS

USE FOR ROW ENDS

USE FOR INTERMEDIATE POSTS

All open "L" uprights are 1 1/8" wide.

All open "T" uprights are 2" wide.



CAT. NO.	PCS/CTN	D	H	WT.	PRICE
1240LO	4	12	40 1/4	5.8	41.00
1540LO	4	15	40 1/4	6.4	42.00
0964LO	6	9	64 1/4	8.5	52.00
1264LO	4	12	64 1/4	8.9	52.00
1564LO	4	15	64 1/4	9.7	55.00
1864LO	4	18	64 1/4	10.0	55.00
2464LO	4	24	64 1/4	11.0	51.00
3064LO	4	30	64 1/4	12.0	54.00
3664LO	4	36	64 1/4	13.0	57.00
0976LO	4	9	76 1/4	9.6	56.00
1076LO	4	10	76 1/4	9.7	58.00
1276LO	6	12	76 1/4	9.9	58.00
1376LO	4	13	76 1/4	9.9	58.00
1576LO	6	15	76 1/4	10.0	58.00
1676LO	4	16	76 1/4	10.3	59.00
1876LO	4	18	76 1/4	11.0	59.00
2076LO	4	20	76 1/4	11.3	62.00
2476LO	4	24	76 1/4	12.0	62.00
2676LO	4	26	76 1/4	12.4	66.00
3076LO	4	30	76 1/4	13.3	66.00
3276LO	4	32	76 1/4	14.0	64.00
3676LO	4	36	76 1/4	14.0	64.00
0985LO	4	9	85 1/4	10.0	63.00
1085LO	4	10	85 1/4	10.3	63.00
1285LO	6	12	85 1/4	11.0	63.00
1385LO	4	13	85 1/4	11.0	63.00
1585LO	6	15	85 1/4	11.0	63.00
1685LO	4	16	85 1/4	11.3	66.00
1885LO	4	18	85 1/4	12.0	66.00
2085LO	4	20	85 1/4	12.3	70.00
2485LO	4	24	85 1/4	13.0	70.00
2685LO	4	26	85 1/4	13.3	75.00
3085LO	4	30	85 1/4	14.0	75.00
3285LO	4	32	85 1/4	14.3	82.00
3685LO	4	36	85 1/4	15.0	82.00
0988LO	4	9	88 1/4	11.0	63.00
1088LO	4	10	88 1/4	11.0	63.00
1288LO	6	12	88 1/4	11.0	63.00
1388LO	4	13	88 1/4	11.0	64.00
1588LO	6	15	88 1/4	11.0	64.00
1688LO	4	16	88 1/4	13.0	66.00
1888LO	4	18	88 1/4	13.0	66.00
2088LO	4	20	88 1/4	13.3	71.00
2488LO	4	24	88 1/4	14.0	71.00
2688LO	4	26	88 1/4	14.3	75.00
3088LO	4	30	88 1/4	15.0	75.00
3288LO	4	32	88 1/4	16.0	84.00
3688LO	4	36	88 1/4	16.0	84.00
0997LO	4	9	97 1/4	12.0	68.00
1297LO	4	12	97 1/4	13.0	66.00
1597LO	4	15	97 1/4	14.0	74.00
1897LO	4	18	97 1/4	15.0	78.00
2497LO	4	24	97 1/4	17.0	79.00
3097LO	4	30	97 1/4	17.0	88.00
3697LO	4	36	97 1/4	18.0	98.00

CAT. NO.	PCS/CTN	D	H	WT.	PRICE
1240TO	3	12	40 1/4	7.9	49.00
1540TO	3	15	40 1/4	8.6	50.00
0964TO	6	9	64 1/4	11.0	62.00
1264TO	3	12	64 1/4	12.0	63.00
1564TO	3	15	64 1/4	13.0	66.00
1864TO	3	18	64 1/4	14.0	67.00
2464TO	3	24	64 1/4	14.7	71.00
3064TO	3	30	64 1/4	15.0	72.00
3664TO	3	36	64 1/4	16.0	66.00
0976TO	6	9	76 1/4	13.4	64.00
1076TO	4	10	76 1/4	13.6	67.00
1276TO ▶	4	12	76 1/4	14.0	67.00
1376TO	4	13	76 1/4	13.7	66.00
1576TO ▶	4	15	76 1/4	13.7	66.00
1676TO	3	16	76 1/4	14.2	70.00
1876TO	3	18	76 1/4	16.0	70.00
2076TO	3	20	76 1/4	16.0	74.00
2476TO ▶	3	24	76 1/4	16.0	74.00
2676TO	3	26	76 1/4	16.7	82.00
3076TO ▶	3	30	76 1/4	18.0	82.00
3276TO	3	32	76 1/4	16.0	90.00
3676TO	3	36	76 1/4	18.0	90.00
0985TO	6	9	85 1/4	12.1	74.00
1085TO	4	10	85 1/4	13.1	73.00
1285TO	4	12	85 1/4	15.0	73.00
1385TO	4	13	85 1/4	15.3	76.00
1585TO	4	15	85 1/4	16.0	76.00
1685TO	3	16	85 1/4	16.3	80.00
1885TO	3	18	85 1/4	17.0	80.00
2085TO	3	20	85 1/4	17.7	84.00
2485TO	3	24	85 1/4	19.0	84.00
2685TO	3	26	85 1/4	19.1	90.00
3085TO	3	30	85 1/4	19.3	90.00
3285TO	3	32	85 1/4	20.0	99.00
3685TO	4	36	85 1/4	22.0	99.00
0988TO	6	9	88 1/4	15.0	75.00
1088TO	4	10	88 1/4	15.0	73.00
1288TO ▶	4	12	88 1/4	15.0	73.00
1388TO	4	13	88 1/4	16.0	78.00
1588TO ▶	4	15	88 1/4	16.0	78.00
1688TO	3	16	88 1/4	18.0	81.00
1888TO	3	18	88 1/4	18.0	81.00
2088TO	3	20	88 1/4	18.0	87.00
2488TO ▶	3	24	88 1/4	18.0	87.00
2688TO	3	26	88 1/4	19.0	92.00
3088TO ▶	3	30	88 1/4	21.0	92.00
3288TO	3	32	88 1/4	23.0	100.00
3688TO	4	36	88 1/4	23.0	100.00
0997TO	6	9	97 1/4	17.0	86.00
1297TO	3	12	97 1/4	18.0	81.00
1597TO	3	15	97 1/4	19.0	89.00
1897TO	3	18	97 1/4	19.0	93.00
2497TO	3	24	97 1/4	21.0	97.00
3097TO	3	30	97 1/4	22.0	106.00
3697TO	3	36	97 1/4	23.0	116.00

Custom heights and/or custom punch spacing on uprights are available on orders of a single size in quantities of 50 pieces or more and/or orders of multiple sizes in quantities of 200 pieces or more. Call factory for pricing.

For L&T Colors [click here](#)
OR
call customer service at: (866) 446-8686

Items with this symbol are available to ship in 2-3 days. Limited quantities and select colors.

▶ (SND) (LGY)

Double Wall (Library) Uprights

DOUBLE WALL UPRIGHTS

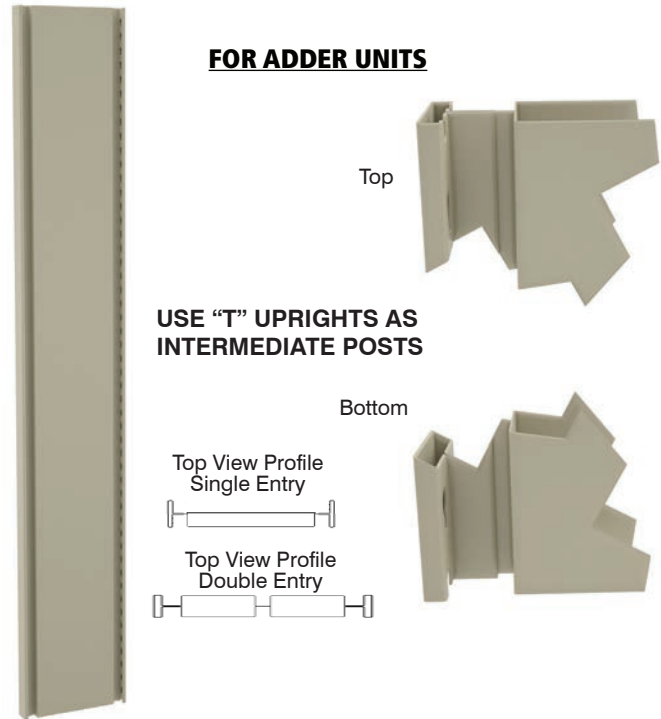
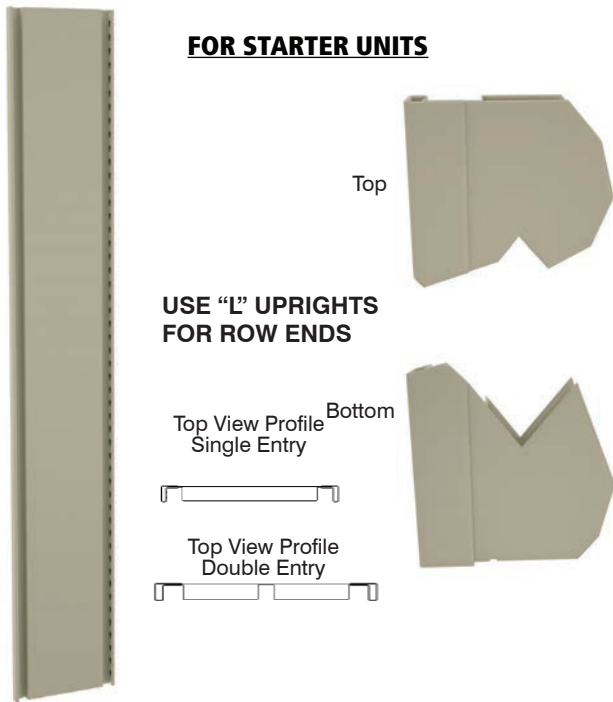

CAT. NO.	PCS/CTN	W	D	H	WT.	PRICE
"L" UPRIGHTS						
1240LL	4	1 1/8	12	40 1/4	12	91.00
1540LL	3	1 1/8	15	40 1/4	14	109.00
0964LL	4	1 1/8	9	64 1/4	16	108.00
1264LL	3	1 1/8	12	64 1/4	19	120.00
1564LL	3	1 1/8	15	64 1/4	21	132.00
1864LL	3	1 1/8	18	64 1/4	23	150.00
2464LL	2	1 1/8	24	64 1/4	28	168.00
3064LL	2	1 1/8	30	64 1/4	33	200.00
0976LL	4	1 1/8	9	76 1/4	18	120.00
1276LL	3	1 1/8	12	76 1/4	20	133.00
1576LL	3	1 1/8	15	76 1/4	21	145.00
1876LL	2	1 1/8	18	76 1/4	23	165.00
2476LL	2	1 1/8	24	76 1/4	29	197.00
3076LL	2	1 1/8	30	76 1/4	35	217.00
0985LL	4	1 1/8	9	85 1/4	21	129.00
1285LL	3	1 1/8	12	85 1/4	23	139.00
1585LL	3	1 1/8	15	85 1/4	25	154.00
1885LL	2	1 1/8	18	85 1/4	26	180.00
2485LL	2	1 1/8	24	85 1/4	35	212.00
3085LL	2	1 1/8	30	85 1/4	44	241.00
0988LL	4	1 1/8	9	88 1/4	21	129.00
1288LL	3	1 1/8	12	88 1/4	24	140.00
1588LL	3	1 1/8	15	88 1/4	25	154.00
1888LL	2	1 1/8	18	88 1/4	27	180.00
2488LL	2	1 1/8	24	88 1/4	34	211.00
3088LL	2	1 1/8	30	88 1/4	41	241.00
0997LL	2	1 1/8	9	97 1/4	23	141.00
1297LL	3	1 1/8	12	97 1/4	28	161.00
1597LL	3	1 1/8	15	97 1/4	31	178.00
1897LL	2	1 1/8	18	97 1/4	33	202.00
2497LL	2	1 1/8	24	97 1/4	41	241.00
3097LL	2	1 1/8	30	97 1/4	49	280.00

CAT. NO.	PCS/CTN	W	D	H	WT.	PRICE
"T" UPRIGHTS						
1240LT	2	1 1/8	12	40 1/4	16	125.00
1540LT	2	1 1/8	15	40 1/4	18	132.00
0964LT	2	1 1/8	9	64 1/4	21	148.00
1264LT	2	1 1/8	12	64 1/4	25	158.00
1564LT	2	1 1/8	15	64 1/4	28	170.00
1864LT	2	1 1/8	18	64 1/4	30	197.00
2464LT	2	1 1/8	24	64 1/4	36	219.00
3064LT	2	1 1/8	30	64 1/4	42	245.00
0976LT	2	1 1/8	9	76 1/4	22	164.00
1276LT	2	1 1/8	12	76 1/4	26	176.00
1576LT	2	1 1/8	15	76 1/4	28	190.00
1876LT	2	1 1/8	18	76 1/4	30	211.00
2476LT	2	1 1/8	24	76 1/4	36	241.00
3076LT	2	1 1/8	30	76 1/4	42	266.00
0985LT	2	1 1/8	9	85 1/4	27	173.00
1285LT	2	1 1/8	12	85 1/4	28	180.00
1585LT	2	1 1/8	15	85 1/4	31	195.00
1885LT	2	1 1/8	18	85 1/4	33	227.00
2485LT	2	1 1/8	24	85 1/4	46	258.00
3085LT	2	1 1/8	30	85 1/4	59	290.00
0988LT	2	1 1/8	9	88 1/4	28	173.00
1288LT	2	1 1/8	12	88 1/4	29	184.00
1588LT	2	1 1/8	15	88 1/4	32	196.00
1888LT	2	1 1/8	18	88 1/4	34	227.00
2488LT	2	1 1/8	24	88 1/4	42	260.00
3088LT	2	1 1/8	30	88 1/4	50	291.00
0997LT	2	1 1/8	9	97 1/4	30	185.00
1297LT	2	1 1/8	12	97 1/4	36	210.00
1597LT	2	1 1/8	15	97 1/4	40	227.00
1897LT	2	1 1/8	18	97 1/4	43	259.00
2497LT	2	1 1/8	24	97 1/4	51	290.00
3097LT	2	1 1/8	30	97 1/4	59	339.00

Thin Profile Shelves (No Slots)

THIN PROFILE SHELVES - 22 GAUGE



CAT. NO.	LOAD CAP.*	Recommended Reinforcements	PCS/ CTN	W	D	H	WT.	PRICE
T2-2412	600	—	16	24	12	25/32	3.1	15.60
T2-2415	500	—	16	24	15	25/32	3.8	19.60
T2-2424	400	1	8	24	24	25/32	5.8	31.00
T2-2430	400	2	8	24	30	25/32	7.2	38.00
T2-3010	600	—	8	30	10	25/32	3.2	15.60
T2-3012	600	—	8	30	12	25/32	3.8	15.60
T2-3013	500	—	8	30	13	25/32	4.1	19.60
T2-3015	500	—	8	30	15	25/32	4.7	19.60
T2-3016	500	1	8	30	16	25/32	4.9	24.00
T2-3018	500	1	8	30	18	25/32	5.5	24.00
T2-3020	400	1	8	30	20	25/32	6.1	31.00
T2-3024	400	1	8	30	24	25/32	7.2	31.00
T2-3026	400	2	8	30	26	25/32	7.7	32.00
T2-3030	400	2	8	30	30	25/32	8.8	38.00
T2-3032	400	2	8	30	32	25/32	9.4	41.00
T2-3609	600	—	16	36	9	25/32	3.6	14.80
T2-3610	600	—	16	36	10	25/32	3.9	15.60
T2-3612	600	—	16	36	12	25/32	4.6	15.60
T2-3613	500	—	8	36	13	25/32	4.6	19.60
T2-3615	500	—	8	36	15	25/32	5.5	19.60
T2-3616	500	1	8	36	16	25/32	5.9	24.00
T2-3618	500	1	8	36	18	25/32	6.5	24.00
T2-3620	400	1	8	36	20	25/32	7.2	31.00
T2-3624	400	1	8	36	24	25/32	8.5	31.00
T2-3626	400	2	8	36	26	25/32	9.2	38.00
T2-3630	400	2	8	36	30	25/32	10.5	38.00
T2-3632	400	2	8	36	32	25/32	11.1	41.00

CAT. NO.	LOAD CAP.*	Recommended Reinforcements	PCS/ CTN	W	D	H	WT.	PRICE
T2-4209	600	—	16	42	9	25/32	4.1	17.00
T2-4210	600	—	12	42	10	25/32	4.5	19.70
T2-4212	600	—	12	42	12	25/32	5.3	19.70
T2-4213	500	—	8	42	13	25/32	5.7	24.00
T2-4215	500	—	8	42	15	25/32	6.4	24.00
T2-4216	500	1	8	42	16	25/32	6.8	29.00
T2-4218	500	1	8	42	18	25/32	7.6	29.00
T2-4220	500	1	8	42	20	25/32	8.3	35.00
T2-4224	500	1	8	42	24	25/32	9.8	35.00
T2-4226	450	2	8	42	26	25/32	10.6	42.00
T2-4230	450	2	8	42	30	25/32	12.0	42.00
T2-4232	450	2	8	42	32	25/32	12.8	46.00
T2-4809	550	—	16	48	9	25/32	4.7	19.50
T2-4810	550	—	12	48	10	25/32	5.1	22.00
T2-4812	550	—	12	48	12	25/32	6.0	22.00
T2-4813	400	—	8	48	13	25/32	6.4	27.00
T2-4815	400	—	8	48	15	25/32	7.3	27.00
T2-4816	350	1	8	48	16	25/32	7.7	31.00
T2-4818	350	1	8	48	18	25/32	8.6	31.00
T2-4820	450	2	8	48	20	25/32	9.5	39.00
T2-4824	450	2	8	48	24	25/32	11.2	39.00
T2-4826	400	2	8	48	26	25/32	12.1	48.00
T2-4830	400	2	6	48	30	25/32	13.8	48.00
T2-4832	400	2	6	48	32	25/32	14.7	54.00

For use with all uprights except double wall (library) uprights. Each shelf requires two shelf supports. Load capacities are based on using the recommended number of TR-dd reinforcements and on using TS-wwgg shelf supports, with weight evenly distributed. Shelves punched for optional center dividers (CD-ww). If using SHS supports, HR-dd reinforcements are required. *NOTE: Load capacities do not apply to mobile units.

CAT. NO.	LOAD CAP.*	Recommended Reinforcements	PCS/ CTN	W	D	H	WT.	PRICE
T-3009	600	—	16	30	9	25/32	5.0	26.00
T-3012	600	—	16	30	12	25/32	5.4	30.00
T-3015	500	—	8	30	15	25/32	8.2	35.00
T-3018	500	1	8	30	18	25/32	9.8	39.00
T-3024	400	1	8	30	24	25/32	13.0	48.00
T-3030	500	2	8	30	30	25/32	16.8	64.00
T-3609	600	—	16	36	9	25/32	5.7	26.00
T-3612	600	—	16	36	12	25/32	7.3	30.00
T-3615	500	—	8	36	15	25/32	8.9	35.00
T-3618	500	1	8	36	18	25/32	10.5	39.00
T-3624	400	1	8	36	24	25/32	13.6	48.00
T-3630	500	2	8	36	30	25/32	18.0	64.00
T-4209	600	—	16	42	9	25/32	6.6	32.00
T-4212	600	—	12	42	12	25/32	8.4	35.00
T-4215	500	—	8	42	15	25/32	10.3	39.00
T-4218	550	1	8	42	18	25/32	12.1	46.00
T-4224	550	2	8	42	24	25/32	15.8	55.00
T-4230	550	2	8	42	30	25/32	19.4	67.00
T-4809	550	—	16	48	9	25/32	7.5	35.00
T-4812	550	—	12	48	12	25/32	9.6	42.00
T-4815	450	—	8	48	15	25/32	11.7	47.00
T-4818	450	1	8	48	18	25/32	13.8	49.00
T-4824	500	2	8	48	24	25/32	17.9	60.00
T-4830	500	2	6	48	30	25/32	22.1	76.00

THIN PROFILE SHELVES - 18 GAUGE



For use with all uprights except double wall (library) uprights. Each shelf requires two shelf supports. Load capacities are based on using the recommended number of TR-dd reinforcements and on using TS-wwgg shelf supports, with weight evenly distributed. Shelves punched for optional center dividers (CD-ww). If using SHS supports, HR-dd reinforcements are required.

*NOTE: Load capacities do not apply to mobile units.

For L&T Colors [click here](#)
OR
call customer service at: (866) 446-8686





 Items with these symbols are available to ship in 2-3 days. Limited quantities and select colors.

	
(SND)	(LGY)
	
(SND)	(LGY)

Thin Profile Slotted Shelves

THIN PROFILE SLOTTED SHELVES - 22 GAUGE



SINGLE ENTRY



DOUBLE ENTRY

CAT. NO.	LOAD CAP.*	Recommended Reinforcements	PCS/ CTN	W	D	H	WT.	PRICE
SINGLE ENTRY								
TQ2-2412	600	—	16	24	12	25/32	3.8	16.80
TQ2-2415	500	—	8	24	15	25/32	3.8	19.60
TQ2-3010	600	—	16	30	10	25/32	3.2	16.80
TQ2-3012 ▶	600	—	16	30	12	25/32	3.8	16.80
TQ2-3013	500	—	8	30	13	25/32	4.1	19.60
TQ2-3015 ▶	500	—	8	30	15	25/32	4.7	19.60
TQ2-3016	500	1	8	30	16	25/32	4.9	24.00
TQ2-3609	600	—	16	36	9	25/32	3.6	15.30
TQ2-3610	600	—	16	36	10	25/32	3.9	16.80
TQ2-3612 ▶	600	—	16	36	12	25/32	4.6	16.80
TQ2-3613	500	—	8	36	13	25/32	4.9	19.60
TQ2-3615 ▶	500	—	8	36	15	25/32	5.5	19.60
TQ2-3616	500	1	8	36	16	25/32	5.9	24.00
TQ2-4209	600	—	16	42	9	25/32	4.1	17.40
TQ2-4210	600	—	16	42	10	25/32	4.5	19.70
TQ2-4212 ▶	600	—	12	42	12	25/32	5.3	19.70
TQ2-4213	500	—	8	42	13	25/32	5.7	24.00
TQ2-4215 ▶	500	—	8	42	15	25/32	6.4	24.00
TQ2-4216	500	1	12	42	16	25/32	6.8	29.00
TQ2-4809	550	—	16	48	9	25/32	4.7	18.40
TQ2-4810	550	—	16	48	10	25/32	5.1	22.00
TQ2-4812 ▶	550	—	12	48	12	25/32	6.0	22.00
TQ2-4813	400	—	8	48	13	25/32	6.4	26.00
TQ2-4815 ▶	400	—	8	48	15	25/32	7.3	26.00
TQ2-4816	350	1	8	48	16	25/32	7.7	31.00

CAT. NO.	LOAD CAP.*	Recommended Reinforcements	PCS/ CTN	W	D	H	WT.	PRICE
DOUBLE ENTRY								
TQD2-2424	400	1	8	24	24	25/32	5.8	31.00
TQD2-2430	400	2	8	24	30	25/32	7.2	38.00
TQD2-3020	400	1	8	30	20	25/32	7.2	31.00
TQD2-3024 ▶	400	1	8	30	24	25/32	7.2	31.00
TQD2-3026	400	2	8	30	26	25/32	7.7	38.00
TQD2-3030	400	2	8	30	30	25/32	8.7	38.00
TQD2-3032	400	2	8	30	32	25/32	9.4	41.00
TQD2-3618	500	1	8	36	18	25/32	6.5	25.00
TQD2-3620	400	1	8	36	20	25/32	7.2	31.00
TQD2-3624 ▶	400	1	8	36	24	25/32	8.5	31.00
TQD2-3626	400	2	8	36	26	25/32	9.2	38.00
TQD2-3630 ▶	400	2	8	36	30	25/32	10.5	38.00
TQD2-3632	400	2	8	36	32	25/32	11.1	41.00
TQD2-4218	500	1	8	42	18	25/32	7.6	29.00
TQD2-4220	500	2	8	42	20	25/32	8.4	34.00
TQD2-4224 ▶	500	2	8	42	24	25/32	9.9	34.00
TQD2-4226	450	2	8	42	26	25/32	10.6	42.00
TQD2-4230 ▶	450	2	8	42	30	25/32	12.1	42.00
TQD2-4232	450	2	8	42	32	25/32	12.9	44.00
TQD2-4818	350	1	8	48	18	25/32	8.6	32.00
TQD2-4820	450	2	8	48	20	25/32	9.5	39.00
TQD2-4824 ▶	450	2	8	48	24	25/32	11.2	39.00
TQD2-4826	400	2	8	48	26	25/32	12.1	49.00
TQD2-4830 ▶	400	2	8	48	30	25/32	13.8	49.00
TQD2-4832	400	2	8	48	32	25/32	14.7	54.00

For use with all uprights except double wall (library) uprights. Each shelf requires two shelf supports. Load capacities are based on using the recommended number of TR-dd reinforcements and using TS-wwgg shelf supports, with weight evenly distributed. If using SHS supports, HR-dd reinforcements are required. Slotted on 2" centers for optional adjustable dividers. *NOTE: Load capacities do not apply to mobile units.

THIN PROFILE SLOTTED SHELVES - 18 GAUGE



SINGLE ENTRY



DOUBLE ENTRY

CAT. NO.	LOAD CAP.*	Recommended Reinforcements	PCS/ CTN	W	D	H	WT.	PRICE
SINGLE ENTRY								
TQ-3009	600	—	16	30	9	25/32	4.7	26.00
TQ-3012	600	—	16	30	12	25/32	6.1	29.00
TQ-3015	500	—	8	30	15	25/32	7.5	34.00
TQ-3609	600	—	16	36	9	25/32	5.7	26.00
TQ-3612	600	—	16	36	12	25/32	7.3	29.00
TQ-3615	500	—	8	36	15	25/32	8.9	34.00
TQ-4209	600	—	16	42	9	25/32	6.6	31.00
TQ-4212	600	—	12	42	12	25/32	8.4	34.00
TQ-4215	500	—	8	42	15	25/32	10.3	42.00
TQ-4809	550	—	16	48	9	25/32	7.5	35.00
TQ-4812	550	—	12	48	12	25/32	9.6	39.00
TQ-4815	450	—	8	48	15	25/32	11.7	43.00

CAT. NO.	LOAD CAP.*	Recommended Reinforcements	PCS/ CTN	W	D	H	WT.	PRICE
DOUBLE ENTRY								
TQD-3018	500	1	8	30	18	25/32	8.8	44.00
TQD-3024	400	1	8	30	24	25/32	13.6	49.00
TQD-3030	500	2	8	30	30	25/32	16.8	59.00
TQD-3618	500	1	8	36	18	25/32	10.5	44.00
TQD-3624	400	1	8	36	24	25/32	13.6	49.00
TQD-3630	500	2	8	36	30	25/32	16.8	59.00
TQD-4218	550	1	8	42	18	25/32	12.1	50.00
TQD-4224	550	2	8	42	24	25/32	15.8	55.00
TQD-4230	550	2	8	42	30	25/32	19.4	68.00
TQD-4818	450	1	8	48	18	25/32	13.8	55.00
TQD-4824	500	2	8	48	24	25/32	17.9	63.00
TQD-4830	500	2	8	48	30	25/32	22.1	78.00

For use with all uprights except double wall (library) uprights. Each shelf requires two shelf supports. Load capacities are based on using the recommended number of TR-dd reinforcements and using TS-wwgg shelf supports, with weight evenly distributed. If using SHS supports, HR-dd reinforcements are required. Slotted on 2" centers for optional adjustable dividers. *NOTE: Load capacities do not apply to mobile units.

For L&T Colors [click here](#)
OR
call customer service at: (866) 446-8686

Items with this symbol are available to ship in 2-3 days. Limited quantities and select colors.

▶ (SND) (LGY)

LIBRARY SINGLE ENTRY SLOTTED SHELVES

CAT. NO.	LOAD CAP.*	Recommended Reinforcements	PCS/ CTN	W	D	H	WT.	PRICE
LQ2-3009	600	—	16	30	9	25/32	2.8	13.80
LQ2-3012	600	—	16	30	12	25/32	3.6	17.10
LQ2-3609	600	—	16	36	9	25/32	3.4	13.80
LQ2-3612	600	—	16	36	12	25/32	4.3	17.10
LQ2-3615	500	—	8	36	15	25/32	5.2	25.00
LQ2-4209	600	—	16	42	9	25/32	3.9	17.10
LQ2-4212	600	—	12	42	12	25/32	5.0	21.00
LQ2-4215	500	—	8	42	15	25/32	6.1	26.00
LQ2-4809	550	—	16	48	9	25/32	4.5	18.50
LQ2-4812	550	—	12	48	12	25/32	5.8	23.00
LQ2-4815	450	—	8	48	15	25/32	7.0	29.00



For use with double wall (library) uprights only. Each shelf requires two shelf supports. Load capacities are based on using the recommended number of TR-dd reinforcements and on using TS-wwgg shelf supports, with weight evenly distributed. If using SHS supports, HR-dd reinforcements are required. 18 gauge shelves also available; Call factory for prices, weights and load capacities.
*NOTE: Load capacities do not apply to mobile units.

LIBRARY DOUBLE ENTRY SLOTTED SHELVES

CAT. NO.	LOAD CAP.*	Recommended Reinforcements	PCS/ CTN	W	D	H	WT.	PRICE
LQD2-3018	500	1	8	30	18	25/32	5.1	26.00
LQD2-3024	400	1	8	30	24	25/32	6.8	31.00
LQD2-3618	500	1	8	36	18	25/32	6.2	26.00
LQD2-3624	400	1	18	36	24	25/32	8.1	31.00
LQD2-3630	400	2	8	36	30	25/32	9.9	41.00
LQD2-4218	500	1	8	42	18	25/32	7.3	30.00
LQD2-4224	500	2	8	42	24	25/32	9.4	36.00
LQD2-4230	450	2	8	42	30	25/32	11.6	47.00
LQD2-4818	350	1	8	48	18	25/32	8.2	32.00
LQD2-4824	450	2	8	48	24	25/32	10.7	43.00
LQD2-4830	400	2	8	48	30	25/32	13.2	49.00



For use with double wall (library) uprights only. Each shelf requires two shelf supports. Load capacities are based on using the recommended number of TR-dd reinforcements and on using TS-wwgg shelf supports, with weight evenly distributed. If using SHS supports, HR-dd reinforcements are required. 18 gauge shelves also available; Call factory for prices, weights and load capacities.
*NOTE: Load capacities do not apply to mobile units.

LIBRARY SHELVES

CAT. NO.	LOAD CAP.*	Recommended Reinforcements	PCS/ CTN	W	D	H	WT.	PRICE
L2-3009	600	—	16	30	9	25/32	2.8	14.60
L2-3012	600	—	16	30	12	25/32	3.6	16.90
L2-3018	500	1	8	30	18	25/32	5.2	25.00
L2-3024	400	1	8	30	24	25/32	6.7	31.00
L2-3609	600	—	16	36	9	25/32	3.4	14.60
L2-3612	600	—	16	36	12	25/32	4.3	16.90
L2-3615	500	—	8	36	15	25/32	5.2	24.00
L2-3618	500	1	8	36	18	25/32	6.2	25.00
L2-3624	400	1	16	36	24	25/32	8.1	31.00
L2-3630	400	2	8	36	30	25/32	9.9	39.00
L2-4209	600	—	16	42	9	25/32	3.9	18.10
L2-4212	600	—	12	42	12	25/32	5.0	21.00
L2-4215	500	—	8	42	15	25/32	6.1	25.00
L2-4218	500	1	8	42	18	25/32	7.2	30.00
L2-4224	500	2	8	42	24	25/32	9.4	36.00
L2-4230	450	2	8	42	30	25/32	11.6	44.00
L2-4809	550	—	16	48	9	25/32	4.5	18.70
L2-4812	550	—	12	48	12	25/32	5.8	23.00
L2-4815	450	—	8	48	15	25/32	7.0	27.00
L2-4818	350	1	8	48	18	25/32	8.2	32.00
L2-4824	450	2	8	48	24	25/32	10.7	41.00
L2-4830	400	2	8	48	30	25/32	13.2	50.00



For use with double wall (library) uprights only. Each shelf requires two shelf supports. Load capacities are based on using the recommended number of TR-dd reinforcements and on using TS-wwgg shelf supports, with weight evenly distributed. If using SHS supports, HR-dd reinforcements are required. 18 gauge shelves also available; Call factory for prices, weights and load capacities.
*NOTE: Load capacities do not apply to mobile units.

For L&T Colors [click here](#)
OR
call customer service at: (866) 446-8686

HEAVY SHELF



May not be used with double wall (library) uprights. Each shelf requires two shelf supports. Load capacities are based on using the recommended number of HR-dd reinforcements and using HS-xx14 shelf supports, with weight evenly distributed.

*NOTE: Load capacities do not apply to mobile units.

CAT. NO.	LOAD CAP.*	Recommended Reinforcements	PCS/CTN	W	D	H	WT.	PRICE
HEAVY SHELF								
H-3612	1,100	—	12	36	12	17/32	7.9	31.00
H-3615	1,000	—	6	36	15	17/32	9.5	35.00
H-3618	950	1	6	36	18	17/32	11.1	40.00
H-3624	900	1	6	36	24	17/32	14.4	49.00
H-3630	1,000	2	4	36	30	17/32	17.6	62.00
H-3636	900	2	4	36	36	17/32	20.8	73.00
H-4212	1,000	—	8	42	12	17/32	9.1	41.00
H-4215	900	—	6	42	15	17/32	11.0	42.00
H-4218	800	1	6	42	18	17/32	12.8	47.00
H-4224	900	2	6	42	24	17/32	16.6	58.00
H-4230	900	2	4	42	30	17/32	20.3	72.00
H-4236	800	2	4	42	36	17/32	24.0	84.00
H-4812	900	—	8	48	12	17/32	10.3	43.00
H-4815	750	—	6	48	15	17/32	12.5	47.00
H-4818	700	1	6	48	18	17/32	14.6	51.00
H-4824	800	2	6	48	24	17/32	18.8	65.00
H-4830	800	2	4	48	30	17/32	23.0	79.00
H-4836	700	2	4	48	36	17/32	27.3	93.00

HEAVY PUNCHED SHELF



May not be used with double wall (library) uprights. For use with bin dividers (LTBD-ddhh). Each shelf requires two shelf supports. Load capacities are based on using the recommended number of HR-dd reinforcements and using HS-ww14 shelf supports, with weight evenly distributed.

*NOTE: Load capacities do not apply to mobile units.

CAT. NO.	LOAD CAP.*	Recommended Reinforcements	PCS/CTN	W	D	H	WT.	PRICE
HEAVY PUNCHED SHELF								
Single Entry								
HP-3612	1,100	—	12	36	12	17/32	7.9	34.00
HP-3615	1,000	—	6	36	15	17/32	9.5	40.00
HP-3618	950	1	6	36	18	17/32	11.1	42.00
HP-4212	1,000	—	8	42	12	17/32	9.1	39.00
HP-4215	900	—	6	42	15	17/32	11.0	44.00
HP-4218	800	1	6	42	18	17/32	12.8	50.00
HP-4812	900	—	8	48	12	17/32	10.3	44.00
HP-4815	750	—	6	48	15	17/32	12.5	46.00
HP-4818	700	1	6	48	18	17/32	14.6	52.00
Double Entry								
HPD-3624	900	1	6	36	24	17/32	14.4	57.00
HPD-3630	1,000	2	4	36	30	17/32	17.6	67.00
HPD-3636	900	2	4	36	36	17/32	20.9	78.00
HPD-4224	900	2	6	42	24	17/32	16.6	64.00
HPD-4230	900	2	4	42	30	17/32	20.3	75.00
HPD-4236	800	2	4	42	36	17/32	24.1	88.00
HPD-4824	800	2	4	48	24	17/32	18.8	72.00
HPD-4830	800	2	4	48	30	17/32	23.1	86.00
HPD-4836	700	2	4	48	36	17/32	27.3	99.00

PARTICLEBOARD SHELVES



For oak-grain finish, change "PBL" to PBLs" and add 50% to shelf price. May not be used with double wall (library) uprights. Each shelf requires two HS or PBS shelf supports. Load capacities are based on using HS-ww14 shelf supports and on weight being evenly distributed.

*NOTE: Load capacities do not apply to mobile units.

CAT. NO.	W	D	H	WT.	PRICE
PBL-3612	35 ⁹ / ₁₆	10 ⁷ / ₈	5/8	7.7	6.90
PBL-3615	35 ⁹ / ₁₆	13 ⁷ / ₈	5/8	9.6	7.60
PBL-3618	35 ⁹ / ₁₆	16 ⁷ / ₈	5/8	11.4	9.90
PBL-3624	35 ⁹ / ₁₆	22 ⁷ / ₈	5/8	15.1	13.90
PBL-3630	35 ⁹ / ₁₆	28 ⁷ / ₈	5/8	19.2	16.50
PBL-3636	35 ⁹ / ₁₆	34 ⁷ / ₈	5/8	23.0	19.60
PBL-4212	41 ⁹ / ₁₆	10 ⁷ / ₈	5/8	8.9	8.80
PBL-4215	41 ⁹ / ₁₆	13 ⁷ / ₈	5/8	11.2	9.40
PBL-4218	41 ⁹ / ₁₆	16 ⁷ / ₈	5/8	13.4	12.50
PBL-4224	41 ⁹ / ₁₆	22 ⁷ / ₈	5/8	17.8	16.40
PBL-4230	41 ⁹ / ₁₆	28 ⁷ / ₈	5/8	23.0	18.10
PBL-4236	41 ⁹ / ₁₆	34 ⁷ / ₈	5/8	27.0	23.00
PBL-4812	47 ⁹ / ₁₆	10 ⁷ / ₈	5/8	10.2	9.30
PBL-4815	47 ⁹ / ₁₆	13 ⁷ / ₈	5/8	12.7	11.60
PBL-4818	47 ⁹ / ₁₆	16 ⁷ / ₈	5/8	15.2	13.10
PBL-4824	47 ⁹ / ₁₆	22 ⁷ / ₈	5/8	20.0	16.70
PBL-4830	47 ⁹ / ₁₆	28 ⁷ / ₈	5/8	25.0	21.00
PBL-4836	47 ⁹ / ₁₆	34 ⁷ / ₈	5/8	31.0	25.00

For L&T Colors [click here](#)

OR

call customer service at: (866) 446-8686

Shelf Supports & Reinforcements, Hang Rods

THIN SHELF SUPPORTS

CAT. NO.	PCS/CTN	W	D	H	WT.	PRICE
14 GAUGE						
TS-2414	30	24	—	3/4	1.0	5.70
TS-3014 ▶	30	30	—	3/4	1.3	5.70
TS-3614 ▶	30	36	—	3/4	1.6	5.70

CAT. NO.	PCS/CTN	W	D	H	WT.	PRICE
11 GAUGE						
TS-3611	30	36	—	3/4	2.5	8.60
TS-4211 ▶	30	42	—	3/4	2.9	9.80
TS-4811 ▶	30	48	—	3/4	3.3	10.80



THIN SHELF REINFORCEMENTS

CAT. NO.	PCS/CTN	W	D	H	WT.	PRICE
TR-09	144	15/16	9	5/8	.3	2.20
TR-10	144	15/16	10	5/8	.4	1.90
TR-12	144	15/16	12	5/8	.5	2.20
TR-13	144	15/16	13	5/8	.5	2.60
TR-15	144	15/16	15	5/8	.6	2.60
TR-16	144	15/16	16	5/8	.7	2.90

CAT. NO.	PCS/CTN	W	D	H	WT.	PRICE
TR-18	72	15/16	18	5/8	.7	2.90
TR-20	72	15/16	20	5/8	1.0	4.10
TR-24 ▶	72	15/16	24	5/8	1.0	4.10
TR-26	72	15/16	26	5/8	1.1	5.10
TR-30 ▶	72	15/16	30	5/8	1.3	5.10
TR-32	72	15/16	32	5/8	1.3	5.10



THIN SHELF SUPPORTS (For Single Entry Only)

CAT. NO.	PCS/CTN	W	D	H	WT.	PRICE
14 GAUGE						
TSC-3614	30	36	—	3/4	1.5	6.40
TSC-4214	30	42	—	3/4	1.9	7.40
TSC-4814	30	48	—	3/4	2.2	8.60

An economical option for use with single-entry units only. TSC-ww14 shelf supports will not accept shelf reinforcements, and thus should not be used on units with depths greater than 15". Two supports required per shelf.



CAT. NO.	PCS/CTN	W	D	H	WT.	PRICE
11 GAUGE						
HS-3611	30	36	—	1 1/8	2.6	10.10
HS-4211	30	42	—	1 1/8	3.1	10.50
HS-4811	30	48	—	1 1/8	3.6	11.70

CAT. NO.	PCS/CTN	W	D	H	WT.	PRICE
14 GAUGE						
HS-3014	30	30	—	1 1/8	1.3	6.00
HS-3614 ▶	30	36	—	1 1/8	1.8	6.00
HS-4214	30	42	—	1 1/8	2.0	7.10
HS-4814 ▶	30	48	—	1 1/8	2.2	7.90



HEAVY SHELF SUPPORTS

CAT. NO.	PCS/CTN	W	D	H	WT.	PRICE
HR-20	48	15/16	20	5/8	1.5	5.60
HR-24 ▶	48	15/16	24	5/8	1.5	5.60
HR-26	48	15/16	26	5/8	1.6	6.70
HR-30 ▶	48	15/16	30	5/8	1.9	6.70
HR-32	48	15/16	32	5/8	2.3	8.20
HR-36	36	15/16	36	5/8	2.3	8.20

CAT. NO.	PCS/CTN	W	D	H	WT.	PRICE
14 GAUGE						
HR-12	96	15/16	12	5/8	.7	3.00
HR-13	96	15/16	13	5/8	.8	3.60
HR-15	96	15/16	15	5/8	.9	3.60
HR-16	96	15/16	16	5/8	1.1	4.20
HR-18	48	15/16	18	5/8	1.1	4.20



HEAVY SHELF REINFORCEMENTS

CAT. NO.	PCS/CTN	W	D	H	WT.	PRICE
SHS-2414	30	24	—	1 3/8	2.0	8.60
SHS-3014 ▶	30	30	—	1 3/8	2.0	8.60
SHS-3614 ▶	30	36	—	1 3/8	2.0	8.60
SHS-4214 ▶	30	42	—	1 3/8	2.4	8.80
SHS-4814 ▶	30	48	—	1 3/8	2.7	9.80

Two supports required per shelf. Use HR-dd reinforcements for 18" & deeper shelves. Use only with bottom shelf, to permit shelf to fit flush with floor or for attachment to mobile bases.

SINGLE RIVET BOTTOM SHELF SUPPORTS



CAT. NO.	PCS/CTN	W	D	H	WT.	PRICE
PBS-3611	30	36	—	3/4	2.4	13.30
PBS-4211	30	42	—	3/4	2.9	14.70
PBS-4811	30	48	—	3/4	3.4	15.30

3/4" profile gives more clearance than HS supports. Two supports required per shelf.

PARTICLEBOARD SHELF SUPPORTS



Hang rod assemblies require two hanging brackets, one hang bar and four galvanized clips (each sold separately, below) to attach. Provides one hanging position.



HANG-ROD COMPONENTS

CAT. NO.	PCS/CTN	W	D	H	WT.	PRICE
HANG BAR						
LTTB-30	1	30	1/2	1 1/2	2.1	16.40
LTTB-36	1	36	1/2	1 1/2	2.1	17.80
LTTB-42	1	42	1/2	1 1/2	2.4	19.20
LTTB-48	1	48	1/2	1 1/2	2.7	21.00
HANG BAR CLIPS						
MC-1P	1	Painted			.1	.36

CAT. NO.	PCS/CTN	W	D	H	WT.	PRICE
HANGING BRACKETS						
HRSB-12	1	1	12	2 1/8	1.2	17.60
HRSB-15	1	1	15	2 1/8	1.5	18.70
HRSB-18	1	1	18	2 1/8	1.9	14.10
HRSB-24	1	1	24	2 1/8	2.5	16.00
HRSB-30	1	1	30	2 1/8	3.2	22.00

For L&T Colors [click here](#)
OR
call customer service at: (866) 446-8686

Items with this symbol are available to ship in 2-3 days. Limited quantities and select colors.



Backs, Reference Shelf, Periodical Shelf

BACKS - ONE PIECE



Packed up to 5 pieces per carton/crate. Top and bottom stiffeners included.

CAT. NO.	W	D	H	WT.	PRICE
30" WIDE					
B-3040	30	—	40 ¹ / ₄	7.6	55.00*
B-3064	30	—	64 ¹ / ₄	12.0	78.00*
B-3076	30	—	76 ¹ / ₄	14.0	89.00*
B-3085	30	—	85 ¹ / ₄	16.0	98.00¥
B-3088	30	—	88 ¹ / ₄	16.0	100.00¥
36" WIDE					
B-3640	36	—	40 ¹ / ₄	15.0	55.00*
B-3664	36	—	64 ¹ / ₄	14.0	78.00*
B-3676	36	—	76 ¹ / ₄	23.0	89.00*
B-3685	36	—	85 ¹ / ₄	28.0	98.00¥
B-3688	36	—	88 ¹ / ₄	26.0	100.00¥

CAT. NO.	W	D	H	WT.	PRICE
42" WIDE					
B-4240	42	—	40 ¹ / ₄	11.0	63.00*
B-4264	42	—	64 ¹ / ₄	17.0	89.00¥
B-4276	42	—	76 ¹ / ₄	32.0	101.00¥
B-4285	42	—	85 ¹ / ₄	22.0	113.00¥
B-4288	42	—	88 ¹ / ₄	36.0	116.00¥
48" WIDE					
B-4840	48	—	40 ¹ / ₄	12.0	70.00*
B-4864	48	—	64 ¹ / ₄	19.0	100.00¥
B-4876	48	—	76 ¹ / ₄	37.0	115.00¥
B-4885	48	—	85 ¹ / ₄	25.0	128.00¥
B-4888	48	—	88 ¹ / ₄	42.0	132.00¥

*Add \$30.00 carton charge per carton. ¥Add \$60.00 crate charge per crate.

BACKS - TWO PIECES



Packed 3 pieces per carton. Top and bottom stiffeners included.

CAT. NO.	W	D	H	WT.	PRICE
30" WIDE					
LTBP-3064-2	30	—	64 ³ / ₁₆	13.0	105.00
LTBP-3076-2	30	—	76 ³ / ₁₆	15.4	115.00
LTBP-3085-2	30	—	85 ³ / ₁₆	17.2	125.00
LTBP-3088-2	30	—	88 ³ / ₁₆	17.8	129.00
LTBP-3097-2	30	—	97 ³ / ₁₆	19.9	137.00
LTBP-30121-2	30	—	121 ³ / ₁₆	25.0	156.00
36" WIDE					
LTBP-3664-2	36	—	64 ³ / ₁₆	15.6	120.00
LTBP-3676-2	36	—	76 ³ / ₁₆	18.6	125.00
LTBP-3685-2	36	—	85 ³ / ₁₆	21.0	136.00
LTBP-3688-2	36	—	88 ³ / ₁₆	21.0	138.00
LTBP-3697-2	36	—	97 ³ / ₁₆	24.0	154.00
LTBP-36121-2	36	—	121 ³ / ₁₆	30.0	178.00

CAT. NO.	W	D	H	WT.	PRICE
42" WIDE					
LTBP-4264-2	42	—	64 ³ / ₁₆	18.3	132.00
LTBP-4276-2	42	—	76 ³ / ₁₆	22.0	149.00
LTBP-4285-2	42	—	85 ³ / ₁₆	24.0	156.00
LTBP-4288-2	42	—	88 ³ / ₁₆	25.0	161.00
LTBP-4297-2	42	—	97 ³ / ₁₆	28.0	176.00
LTBP-42121-2	42	—	121 ³ / ₁₆	35.0	197.00
48" WIDE					
LTBP-4864-2	48	—	64 ³ / ₁₆	21.0	144.00
LTBP-4876-2	48	—	76 ³ / ₁₆	25.0	160.00
LTBP-4885-2	48	—	85 ³ / ₁₆	28.0	171.00
LTBP-4888-2	48	—	88 ³ / ₁₆	29.0	177.00
LTBP-4897-2	48	—	97 ³ / ₁₆	32.0	192.00
LTBP-48121-2	48	—	121 ³ / ₁₆	40.0	220.00

SEISMIC BACKS



Packed as ordered. Helps reinforce shelving units in seismic zones.

CAT. NO.	W	D	H	WT.	PRICE
30" WIDE					
CFB-3076	30	—	76 ¹ / ₄	25.0	108.00
CFB-3085	30	—	85 ¹ / ₄	27.0	120.00
CFB-3088	30	—	88 ¹ / ₄	28.0	124.00
CFB-3097	30	—	97 ¹ / ₄	36.0	136.00
36" WIDE					
CFB-3676	36	—	76 ¹ / ₄	29.0	108.00
CFB-3685	36	—	85 ¹ / ₄	32.0	120.00
CFB-3688	36	—	88 ¹ / ₄	33.0	124.00
CFB-3697	36	—	97 ¹ / ₄	36.0	136.00

CAT. NO.	W	D	H	WT.	PRICE
42" WIDE					
CFB-4276	42	—	76 ¹ / ₄	33.0	125.00
CFB-4285	42	—	85 ¹ / ₄	37.0	139.00
CFB-4288	42	—	88 ¹ / ₄	39.0	144.00
CFB-4297	42	—	97 ¹ / ₄	42.0	158.00
48" WIDE					
CFB-4876	48	—	76 ¹ / ₄	38.0	143.00
CFB-4885	48	—	85 ¹ / ₄	43.0	158.00
CFB-4888	48	—	88 ¹ / ₄	44.0	164.00
CFB-4897	48	—	97 ¹ / ₄	49.0	180.00

REFERENCE SHELF KITS



Shelf is 11⁷/₈" deep. Reduces filing space by 1". Kit comes with mounting brackets and one shelf. Brackets and shelves packed separately. For double entry units, order extra shelf.

CAT. NO.	PCS/CTN	W	D	H	WT.	PRICE
Used on 36", 42" or 48" wide units						
RSMB-12▶	2	30	12	5 ⁵ / ₈	9.3	62.00
RSMB-15▶	2	30	15	5 ⁵ / ₈	9.7	64.00
RSMB-18	2	30	18	5 ⁵ / ₈	10.0	65.00
RSMB-24▶	2	30	24	5 ⁵ / ₈	10.8	68.00
RSMB-30▶	2	30	30	5 ⁵ / ₈	11.6	71.00
RSMB-36	2	30	36	5 ⁵ / ₈	12.4	75.00
30" WIDE EXTRA SHELF (FOR DOUBLE ENTRY UNITS)						
RS-3012▶	2	30	11 ⁷ / ₈	5 ⁵ / ₈	7.2	52.00

CAT. NO.	PCS/CTN	W	D	H	WT.	PRICE
Used on 30" wide units						
RSMB-12-24	2	24	12	5 ⁵ / ₈	7.9	73.00
RSMB-15-24	2	24	15	5 ⁵ / ₈	8.3	74.00
RSMB-18-24	2	24	18	5 ⁵ / ₈	8.6	75.00
RSMB-24-24	2	24	24	5 ⁵ / ₈	9.4	79.00
RSMB-30-24	2	24	30	5 ⁵ / ₈	10.2	82.00
RSMB-36-24	2	24	36	5 ⁵ / ₈	11.0	86.00
24" WIDE EXTRA SHELF (FOR DOUBLE ENTRY UNITS)						
RS-2412	2	24	11 ⁷ / ₈	5 ⁵ / ₈	5.8	72.00

PERIODICAL SHELVES



Used for displaying media such as magazines, journals, etc.

CAT. NO.	PCS/CTN	W	D	H	WT.	PRICE
LTPD-30	8	30	14	1 ⁵ / ₁₆	8.7	57.00
LTPD-36	8	36	14	1 ⁵ / ₁₆	10.1	52.00
LTPD-42	8	42	14	1 ⁵ / ₁₆	11.7	64.00
LTPD-48	8	48	14	1 ⁵ / ₁₆	13.2	68.00

For quantities less than 25 pieces, add \$300/list setup charge.

For L&T Colors [click here](#)
OR
call customer service at: (866) 446-8686

▶ Items with this symbol are available to ship in 2-3 days. Limited quantities and select colors.



LOCKING DOOR KITS (For HIPAA Compliance)

CAT. NO.	PCS/CTN	W	D	H	WT.	PRICE
HINGED DOOR KIT — Fits Single Units						
LTHD-3676RH	—	36	1 3/4	76	56	472.00
LTHD-4276RH	—	42	1 3/4	76	64	534.00
LTHD-4876RH	—	48	1 3/4	76	81	663.00
LTHD-3688RH	—	36	1 3/4	88	63	491.00
LTHD-4288RH	—	42	1 3/4	88	74	661.00
LTHD-4888RH	—	48	1 3/4	88	84	728.00
EXTENDED HINGED DOOR KIT* — Fits Single Units**						
LTHD-3676RHD	—	36	2 3/4	76	60	526.00
LTHD-4276RHD	—	42	2 3/4	76	68	644.00
LTHD-4876RHD	—	48	2 3/4	76	86	727.00
LTHD-3688RHD	—	36	2 3/4	88	68	524.00
LTHD-4288RHD	—	42	2 3/4	88	79	692.00
LTHD-4888RHD	—	48	2 3/4	88	89	757.00



LTHD-4276RH
Hinged Door for Single Units —
Extends 1 3/4" from front of unit; door
frame uses 1/2" vertical filing space.

*Provides additional clearance for filing with end tab file folders.

**Extends 2 3/4" from front of unit:

Door frame uses 1/2" vertical filing space.

For optional keyed alike lock (\$18 List), add "KA" to catalog number.

For optional keyed specific lock (\$18 List), add "KS" to catalog number.

All doors come standard with lock, in compliance with Health Insurance Portability and Accountability Act of 1996 (HIPAA) regulations.

ADJUSTABLE DIVIDERS

CAT. NO.	PCS/CTN	W	D	H	WT.	PRICE
ADJUSTABLE FILE DIVIDER (STEEL)						
FD-0808*	40	—	8	8	.5	3.40
FD-1108**▶	50	—	11	8	.8	2.90
FDP-1108▶	50	—	11	8	.8	2.90
ADJUSTABLE FILE DIVIDER (PLASTIC)						
PD-1108	25	—	11	8	.4	2.70

*Use FD-0808 with TQ2-ww09, TQD2-ww18,

LQ2-ww09 & LQD2-ww18.

**Includes Tensco imprint.

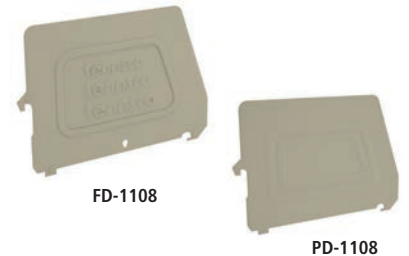

FD-1108

PD-1108

COMPRESSION DIVIDERS

CAT. NO.	PCS/CTN	W	D	H	WT.	PRICE
ADJUSTABLE DIVIDER (COMPRESSION)†						
AD-0907	50	—	9	7	.6	4.80
AD-1107	50	—	11	7	1.0	6.70



AD-0907

†Use with CBS-ww or CCS-ww

WIRE DIVIDER AND BACKSTOPS

CAT. NO.	PCS/CTN	W	D	H	WT.	PRICE
SLIDING WIRE DIVIDER						
TWD-1	—	—	8	6	.5	13.80
WIRE DIVIDER BACKSTOPS						
WDBS-36	40	36	—	2	1.4	8.20
WDBS-42	40	42	—	2	1.6	9.10
WDBS-48	40	48	—	2	1.8	10.10



TWD-1

CHROME
PLATED

Packed as ordered.



WDBS-42

Use with TWD-1 (Sliding Wire Dividers)
Can only be used with single entry units.

For L&T Colors [click here](#)
OR
call customer service at: (866) 446-8686

▶
Items with this symbol are
available to ship in 2-3 days.
Limited quantities
and select colors.



(SND)

(LGY)

Back Stops, Center Stops, Nylon Feet

BIN DIVIDERS, BACK STOPS AND FRONTS



LTBD-1215

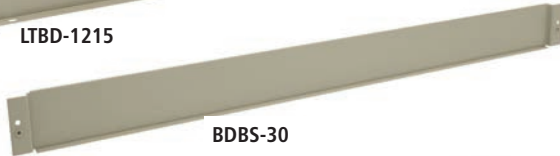

BDBS-30

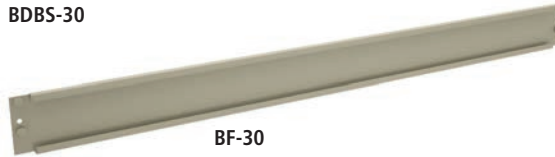

BF-30

*Use with HP-wvdd or HPD-wvdd shelves only.
**Use with bin dividers on single entry units only.

CAT. NO.	PCS/CTN	W	D	H	WT.	PRICE
BIN DIVIDER*						
LTBD-1206	30	—	12	6	.7	5.10
LTBD-1209	30	—	12	9	1.1	6.40
LTBD-1212	30	—	12	12	1.4	9.60
LTBD-1215	30	—	12	15	1.7	9.10
LTBD-1506	30	—	15	6	.9	6.30
LTBD-1509	30	—	15	9	1.3	7.90
LTBD-1512	30	—	15	12	1.7	9.50
LTBD-1515	30	—	15	15	2.1	10.80
LTBD-1806	30	—	18	6	1.1	7.80
LTBD-1809	30	—	18	9	1.6	8.80
LTBD-1812	30	—	18	12	2.0	10.60
LTBD-1815	30	—	18	15	2.5	12.80

CAT. NO.	PCS/CTN	W	D	H	WT.	PRICE
BIN DIVIDER BACK STOP**						
BDBS-30	30	30	—	3	1.7	17.10
BDBS-36	30	36	—	3	1.7	17.10
BDBS-42	30	42	—	3	2.0	19.00
BDBS-48	30	48	—	3	2.3	21.00
BIN FRONT						
BF-30	20	30	—	3	1.2	9.70
BF-36	30	36	—	3	1.4	9.70
BF-42	30	42	—	3	1.7	10.70
BF-48	30	48	—	3	1.9	11.50

SLOTTED AND ADJUSTABLE BACK STOPS



SLOTTED BACK STOPS
Use with FD-0808, FD-1108,
FDP-1108, FD-1612, PD-1108



ADJUSTABLE BACK STOPS (COMPRESSION)
Use with AD-0907 OR AD-1107

CAT. NO.	PCS/CTN	W	D	H	WT.	PRICE
SLOTTED BACK STOPS						
BS-30 ▶	40	30	—	2	1.2	6.00
BS-36 ▶	40	36	—	2	1.3	6.00
BS-42 ▶	40	42	—	2	1.6	6.80
BS-48 ▶	40	48	—	2	1.8	7.60
ADJUSTABLE BACK STOPS (COMPRESSION)						
CBS-36	18	36	3/8	2	1.6	20.00
CBS-42	18	42	3/8	2	1.9	21.00
CBS-48	18	48	3/8	2	2.1	22.00

SLOTTED CENTER STOPS



Use with double entry thin
slotted shelves only.

CAT. NO.	PCS/CTN	W	D	H	WT.	PRICE
SLOTTED CENTER STOP*						
CS-30 ▶	20	30	—	4	1.9	8.30
CS-36 ▶	20	36	—	4	2.2	8.30
CS-42 ▶	20	42	—	4	2.6	9.70
CS-48 ▶	20	48	—	4	3.0	10.90

ADJUSTABLE CENTER STOPS (COMPRESSION)



Use with AD-0907 or
AD-1107 (Adjustable Dividers)

CAT. NO.	PCS/CTN	W	D	H	WT.	PRICE
CCS-36	20	36	3/8	4	2.7	25.00
CCS-42	20	42	3/8	4	3.1	29.00
CCS-48	20	48	3/8	4	3.6	30.00

UNSLOTTED CENTER DIVIDERS



Use with unslotted shelves to divide shelves
into equal halves. Not available for
use on 9" deep shelves.

CAT. NO.	PCS/CTN	W	D	H	WT.	PRICE
CD-30	50	30	3/8	2	1.4	10.10
CD-36	50	36	3/8	2	1.4	10.10
CD-42	50	42	3/8	2	1.6	11.10
CD-48	50	48	3/8	2	1.8	12.10

NYLON FEET



Foot For "T" Uprights



Foot For "L" Uprights

Black nylon foot shaped to fit each type of
L&T upright. May also be used as an upright
top cap. Two required per upright.

CAT. NO.	DESCRIPTION	PRICE
LTNF-L	Fits "L" Uprights	1.40
LTNF-T	Fits "T" Uprights	1.40

For L&T Colors [click here](#)

OR

call customer service at: (866) 446-8686

Items with this symbol are
available to ship in 2-3 days.
Limited quantities
and select colors.

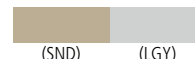

(SND)

(LGY)

SEISMIC FULL HEIGHT CENTER STOPS

CAT. NO.	PCS/CTN	W	D	H	WT.	PRICE
FOR LETTER AND LEGAL FILING						
FHCS-3010.5	8	30	—	10½	6.2	48.00
FHCS-3012	8	30	—	12	6.9	51.00
FHCS-3013.5	8	30	—	13½	7.3	54.00
FHCS-3015	8	30	—	15	8.2	56.00
FHCS-3610.5	8	36	—	10½	7.4	48.00
FHCS-3612	8	36	—	12	8.2	51.00
FHCS-3613.5	8	36	—	13½	9.0	54.00
FHCS-3615	8	36	—	15	9.7	56.00
FHCS-4210.5	8	42	—	10½	8.6	54.00
FHCS-4212	8	42	—	12	9.5	56.00
FHCS-4213.5	8	42	—	13½	10.4	59.00
FHCS-4215	8	42	—	15	11.3	63.00
FHCS-4810.5	8	48	—	10½	9.7	57.00
FHCS-4812	8	48	—	12	10.8	62.00
FHCS-4813.5	8	48	—	13½	11.8	64.00
FHCS-4815	8	48	—	15	12.8	68.00



Used to help reinforce shelving units in seismic zones.

For quantities less than 100 pieces, add \$500/list setup charge.

FRONT BASES

CAT. NO.	PCS/CTN	W	D	H	WT.	PRICE
FB-3002	50	30	—	2 5/16	.7	4.60
FB-3602 ▶	50	36	—	2 5/16	1.0	4.60
FB-4202 ▶	50	42	—	2 5/16	1.1	5.20
FB-4802 ▶	50	48	—	2 5/16	1.3	6.00

CAT. NO.	PCS/CTN	W	D	H	WT.	PRICE
FB-3004 ▶	50	30	—	3 5/16	1.1	6.60
FB-3604 ▶	50	36	—	3 5/16	1.6	6.60
FB-4204 ▶	50	42	—	3 5/16	1.8	7.80
FB-4804 ▶	50	48	—	3 5/16	2.0	8.70



Acts as a kickplate and provides a flush, finished appearance.

CAT. NO.	PCS/CTN	W	D	H	WT.	PRICE
LTAT-36	10	36	—	2 3/4	3.0	27.00
LTAT-42	10	42	—	2 3/4	3.4	29.00
LTAT-48	10	48	—	2 3/4	3.9	30.00

Use to tie units together across aisle for extra stabilization in tall units. Other lengths available upon request; consult factory for pricing.



AISLE TIES

CAT. NO.	W	D	H	WT.	PRICE
BSN6	4 5/8	1 3/4	6	.6	6.80
BSN9	4 5/8	1 3/4	9	1.1	8.20

Non-skid base included; packed as ordered.



BOOK SUPPORTS

CAT. NO.	DESCRIPTION	PRICE
LTCP-1	Ties posts back-to-back	1.80
LTPF-1	For protection of carpeting	.36
LTPS-1	Shim to help adjust for uneven floor	.88
LTWT-1 ▶	Attaches post to wall for added security	2.00
LTUC-1	Ties posts back-to-back	.86
LTSP-1	Prevents shelf support from slipping	.51
LTSI-36	Provides extra stability for seismic standards	8.40
LTUP-1 ▶	To touch up scrapes and scratches	9.20
LTSPL-1	Splice for extending existing posts	3.10
SCH-P	Holds 3x5" cards for shelf labeling	3.70



MISCELLANEOUS L&T PARTS

CAT. NO.	DESCRIPTION	SIZE	PRICE
SMALL LEVELER (FOR USE ON CONCRETE/TILE FLOOR)			
LPLI-S	Fits "L" Uprights	1/4"-20 x 9/16"	1.40
TPLI-S	Fits "T" Uprights	1/4"-20 x 9/16"	1.40
LARGE LEVELER (FOR USE ON CARPET)			
LPLI-L	Fits "L" Uprights	1/4"-20 x 1 3/8"	2.50
TPLI-L	Fits "T" Uprights	1/4"-20 x 1 3/8"	1.40



For carpeting



For hard floors

LEVELING FEET

For L&T Colors [click here](#)
OR
call customer service at: (866) 446-8686

Items with this symbol are available to ship in 2-3 days. Limited quantities and select colors.



36" Wide Drawers

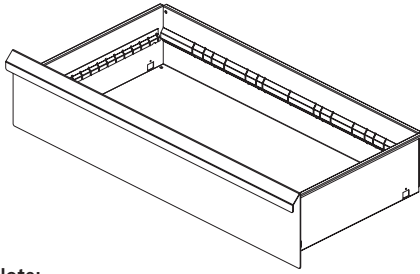

Four Steps to configuring your L&T High Density Drawer System:

1. Select the drawer width and depth (pages 94-96) that match your shelving.
2. To determine height of the drawer needed, compare the height of the item being stored with the column marked "drawer height – usable inside" (pages 94-96) and select the height that will provide you a height at least as great as the item being stored.
3. To determine the number of columns in the drawer, compare width of item being stored with the column marked "usable divider width" (pages 97-99) and select the number of columns that will provide you a width at least as great as the item being stored.
4. Add spreaders and kickplates (page 99) for added rigidity and a clean appearance. Each unit should have a minimum of 4 pairs made up of a combination of double rivet shelf supports and/or spreaders.

Note:

- Depth of drawers MUST match shelving unit.
- Dual entry access is available for 30" and 36" only. (i.e., 30" depth unit allows two 15" drawers on same level)
- Never open more than one drawer at a time.
- We strongly recommend that all shelving, especially shelving containing modular drawers, be floor or wall anchored.
- 18" Lateral drawers can accommodate both letter and legal sized files side-to-side.
- 15" Lateral drawers can only accommodate letter sized files side-to-side. For legal sized files, front-to-back cross rods (page 34) must be used.
- See supplemental brochure for possible lateral drawer configurations.

Each drawer includes:

Drawer, Mounting Brackets, Suspensions, Full Length Label Holder, Label and Clear Label Cover

15" DEEP SHELVING

*Double entry units are supplied with one suspension and one mounting bracket.

CAT. NO.	DESCRIPTION	L&T SHELVING TYPE*	DRAWER HEIGHT			INSIDE DRAWER WIDTH	INSIDE DRAWER DEPTH	WT.	PRICE
			Body	Front	Usable Inside				
B23615-30S	3" Drawer	Single Entry	2"	2 13/16"	2 1/2"	31 3/32"	13"	24.0	294.00
B23615-30D	3" Drawer	Double Entry	2"	2 13/16"	2 1/2"	31 3/32"	13"	24.0	294.00
B23615-45S	4 1/2" Drawer	Single Entry	3"	4 5/16"	3 7/8"	31 3/32"	13"	27.0	350.00
B23615-45D	4 1/2" Drawer	Double Entry	3"	4 5/16"	3 7/8"	31 3/32"	13"	27.0	350.00
B23615-60S	6" Drawer	Single Entry	4 1/2"	5 13/16"	5 1/2"	31 3/32"	13"	31.0	380.00
B23615-60D	6" Drawer	Double Entry	4 1/2"	5 13/16"	5 1/2"	31 3/32"	13"	31.0	380.00
B23615-75S	7 1/2" Drawer	Single Entry	6"	7 5/16"	7"	31 3/32"	13"	34.0	418.00
B23615-75D	7 1/2" Drawer	Double Entry	6"	7 5/16"	7"	31 3/32"	13"	33.8	418.00
B23615-90S	9" Drawer	Single Entry	7"	8 13/16"	8 1/2"	31 3/32"	13"	35.0	426.00
B23615-90D	9" Drawer	Double Entry	7"	8 13/16"	8 1/2"	31 3/32"	13"	35.0	426.00
B23615-105S	10 1/2" Drawer	Single Entry	9"	10 5/16"	10"	31 3/32"	13"	36.0	430.00
B23615-105D	10 1/2" Drawer	Double Entry	9"	10 5/16"	10"	31 3/32"	13"	36.0	430.00
B23615-120S	12" Lateral Drawer	Single Entry	9 11/16"	11 11/16"	11 7/16"	31 3/32"	13"	36.0	373.00
B23615-120D	12" Lateral Drawer	Double Entry	9 11/16"	11 11/16"	11 7/16"	31 3/32"	13"	36.0	373.00

18" DEEP SHELVING

*Double entry units are supplied with one suspension and one mounting bracket.

CAT. NO.	DESCRIPTION	L&T SHELVING TYPE*	DRAWER HEIGHT			INSIDE DRAWER WIDTH	INSIDE DRAWER DEPTH	WT.	PRICE
			Body	Front	Usable Inside				
B23618-30S	3" Drawer	Single Entry	2"	2 13/16"	2 1/2"	31 3/32"	16"	25.0	328.00
B23618-30D	3" Drawer	Double Entry	2"	2 13/16"	2 1/2"	31 3/32"	16"	25.0	324.00
B23618-45S	4 1/2" Drawer	Single Entry	3"	4 5/16"	3 7/8"	31 3/32"	16"	29.0	363.00
B23618-45D	4 1/2" Drawer	Double Entry	3"	4 5/16"	3 7/8"	31 3/32"	16"	29.0	363.00
B23618-60S	6" Drawer	Single Entry	4 1/2"	5 13/16"	5 1/2"	31 3/32"	16"	33.0	415.00
B23618-60D	6" Drawer	Double Entry	4 1/2"	5 13/16"	5 1/2"	31 3/32"	16"	33.0	415.00
B23618-75S	7 1/2" Drawer	Single Entry	6"	7 5/16"	7"	31 3/32"	16"	36.0	433.00
B23618-75D	7 1/2" Drawer	Double Entry	6"	7 5/16"	7"	31 3/32"	16"	36.0	433.00
B23618-90S	9" Drawer	Single Entry	7"	8 13/16"	8 1/2"	31 3/32"	16"	37.0	442.00
B23618-90D	9" Drawer	Double Entry	7"	8 13/16"	8 1/2"	31 3/32"	16"	37.0	442.00
B23618-105S	10 1/2" Drawer	Single Entry	9"	10 5/16"	10"	31 3/32"	16"	38.0	435.00
B23618-105D	10 1/2" Drawer	Double Entry	9"	10 5/16"	10"	31 3/32"	16"	38.0	435.00
B23618-120S	12" Lateral Drawer	Single Entry	9 11/16"	11 11/16"	11 7/16"	31 3/32"	16"	32.0	393.00
B23618-120D	12" Lateral Drawer	Double Entry	9 11/16"	11 11/16"	11 7/16"	31 3/32"	16"	32.0	393.00

24" DEEP SHELVING

CAT. NO.	DESCRIPTION	L&T SHELVING TYPE*	DRAWER HEIGHT			INSIDE DRAWER WIDTH	INSIDE DRAWER DEPTH	WT.	PRICE
			Body	Front	Usable Inside				
B23624-30S	3" Drawer	Single Entry	2"	2 13/16"	2 1/2"	31 3/32"	22"	28.0	365.00
B23624-45S	4 1/2" Drawer	Single Entry	3"	4 5/16"	3 7/8"	31 3/32"	22"	32.0	402.00
B23624-60S	6" Drawer	Single Entry	4 1/2"	5 13/16"	5 1/2"	31 3/32"	22"	36.0	476.00
B23624-75S	7 1/2" Drawer	Single Entry	6"	7 5/16"	7"	31 3/32"	22"	39.0	505.00
B23624-90S	9" Drawer	Single Entry	7"	8 13/16"	8 1/2"	31 3/32"	22"	40.0	500.00
B23624-105S	10 1/2" Drawer	Single Entry	9"	10 5/16"	10"	31 3/32"	22"	41.0	520.00

For L&T Colors [click here](#)

OR

call customer service at: (866) 446-8686

42" Wide Drawers

Four Steps to configuring your L&T High Density Drawer System:

1. Select the drawer width and depth (pages 94-96) that match your shelving.
2. To determine height of the drawer needed, compare the height of the item being stored with the column marked "drawer height – usable inside" (pages 94-96) and select the height that will provide you a height at least as great as the item being stored.
3. To determine the number of columns in the drawer, compare width of item being stored with the column marked "usable divider width" (pages 97-99) and select the number of columns that will provide you a width at least as great as the item being stored.
4. Add spreaders and kickplates (page 99) for added rigidity and a clean appearance. Each unit should have a minimum of 4 pairs made up of a combination of double rivet shelf supports and/or spreaders.

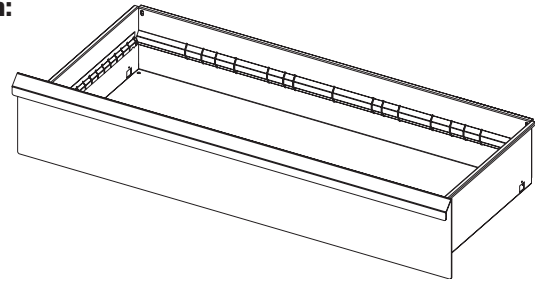

Note:

- Depth of drawers MUST match shelving unit.
- Dual entry access is available for 30" and 36" only. (i.e., 30" depth unit allows two 15" drawers on same level)
- Never open more than one drawer at a time.
- We strongly recommend that all shelving, especially shelving containing modular drawers, be floor or wall anchored.
- 18" Lateral drawers can accommodate both letter and legal sized files side-to-side.
- 15" Lateral drawers can only accommodate letter sized files side-to-side. For legal sized files, front-to-back cross rods (page 34) must be used.
- See supplemental brochure for possible lateral drawer configurations.

Each drawer includes:

Drawer, Mounting Brackets, Suspensions, Full Length Label Holder, Label and Clear Label Cover

*Double entry units are supplied with one suspension and one mounting bracket.

15" DEEP SHELVING

CAT. NO.	DESCRIPTION	L&T SHELVING TYPE*	DRAWER HEIGHT			INSIDE DRAWER WIDTH	INSIDE DRAWER DEPTH	WT.	PRICE
			Body	Front	Usable Inside				
B24215-30S	3" Drawer	Single Entry	2"	2 13/16"	2 1/2"	37 3/32"	13"	25.0	312.00
B24215-30D	3" Drawer	Double Entry	2"	2 13/16"	2 1/2"	37 3/32"	13"	25.0	312.00
B24215-45S	4 1/2" Drawer	Single Entry	3"	4 5/16"	3 7/8"	37 3/32"	13"	28.0	362.00
B24215-45D	4 1/2" Drawer	Double Entry	3"	4 5/16"	3 7/8"	37 3/32"	13"	28.0	362.00
B24215-60S	6" Drawer	Single Entry	4 1/2"	5 13/16"	5 1/2"	37 3/32"	13"	32.0	410.00
B24215-60D	6" Drawer	Double Entry	4 1/2"	5 13/16"	5 1/2"	37 3/32"	13"	32.0	410.00
B24215-75S	7 1/2" Drawer	Single Entry	6"	7 5/16"	7"	37 3/32"	13"	35.0	416.00
B24215-75D	7 1/2" Drawer	Double Entry	6"	7 5/16"	7"	37 3/32"	13"	35.0	410.00
B24215-90S	9" Drawer	Single Entry	7"	8 13/16"	8 1/2"	37 3/32"	13"	36.0	428.00
B24215-90D	9" Drawer	Double Entry	7"	8 13/16"	8 1/2"	37 3/32"	13"	36.0	428.00
B24215-105S	10 1/2" Drawer	Single Entry	9"	10 5/16"	10"	37 3/32"	13"	38.0	444.00
B24215-105D	10 1/2" Drawer	Double Entry	9"	10 5/16"	10"	37 3/32"	13"	38.0	444.00
B24215-120S	12" Lateral Drawer	Single Entry	9 11/16"	11 11/16"	11 7/16"	37 3/32"	13"	32.0	376.00
B24215-120D	12" Lateral Drawer	Double Entry	9 11/16"	11 11/16"	11 7/16"	37 3/32"	13"	32.0	376.00

*Double entry units are supplied with one suspension and one mounting bracket.

18" DEEP SHELVING

CAT. NO.	DESCRIPTION	L&T SHELVING TYPE*	DRAWER HEIGHT			INSIDE DRAWER WIDTH	INSIDE DRAWER DEPTH	WT.	PRICE
			Body	Front	Usable Inside				
B24218-30S	3" Drawer	Single Entry	2"	2 13/16"	2 1/2"	37 3/32"	16"	26.0	328.00
B24218-30D	3" Drawer	Double Entry	2"	2 13/16"	2 1/2"	37 3/32"	16"	26.0	324.00
B24218-45S	4 1/2" Drawer	Single Entry	3"	4 5/16"	3 7/8"	37 3/32"	16"	30.0	373.00
B24218-45D	4 1/2" Drawer	Double Entry	3"	4 5/16"	3 7/8"	37 3/32"	16"	30.0	368.00
B24218-60S	6" Drawer	Single Entry	4 1/2"	5 13/16"	5 1/2"	37 3/32"	16"	34.0	411.00
B24218-60D	6" Drawer	Double Entry	4 1/2"	5 13/16"	5 1/2"	37 3/32"	16"	34.0	411.00
B24218-75S	7 1/2" Drawer	Single Entry	6"	7 5/16"	7"	37 3/32"	16"	37.0	424.00
B24218-75D	7 1/2" Drawer	Double Entry	6"	7 5/16"	7"	37 3/32"	16"	37.0	424.00
B24218-90S	9" Drawer	Single Entry	7"	8 13/16"	8 1/2"	37 3/32"	16"	38.0	431.00
B24218-90D	9" Drawer	Double Entry	7"	8 13/16"	8 1/2"	37 3/32"	16"	38.0	431.00
B24218-105S	10 1/2" Drawer	Single Entry	9"	10 5/16"	10"	37 3/32"	16"	39.0	447.00
B24218-105D	10 1/2" Drawer	Double Entry	9"	10 5/16"	10"	37 3/32"	16"	39.0	430.00
B24218-120S	12" Lateral Drawer	Single Entry	9 11/16"	11 11/16"	11 7/16"	37 3/32"	16"	34.0	389.00
B24218-120D	12" Lateral Drawer	Double Entry	9 11/16"	11 11/16"	11 7/16"	37 3/32"	16"	34.0	415.00

24" DEEP SHELVING

CAT. NO.	DESCRIPTION	L&T SHELVING TYPE*	DRAWER HEIGHT			INSIDE DRAWER WIDTH	INSIDE DRAWER DEPTH	WT.	PRICE
			Body	Front	Usable Inside				
B24224-30S	3" Drawer	Single Entry	2"	2 13/16"	2 1/2"	37 3/32"	22"	29.0	380.00
B24224-45S	4 1/2" Drawer	Single Entry	3"	4 5/16"	3 7/8"	37 3/32"	22"	33.0	427.00
B24224-60S	6" Drawer	Single Entry	4 1/2"	5 13/16"	5 1/2"	37 3/32"	22"	37.0	472.00
B24224-75S	7 1/2" Drawer	Single Entry	6"	7 5/16"	7"	37 3/32"	22"	40.0	511.00
B24224-90S	9" Drawer	Single Entry	7"	8 13/16"	8 1/2"	37 3/32"	22"	40.0	492.00
B24224-105S	10 1/2" Drawer	Single Entry	9"	10 5/16"	10"	37 3/32"	22"	43.0	520.00

For L&T Colors [click here](#)

OR

call customer service at: (866) 446-8686

48" Wide Drawers

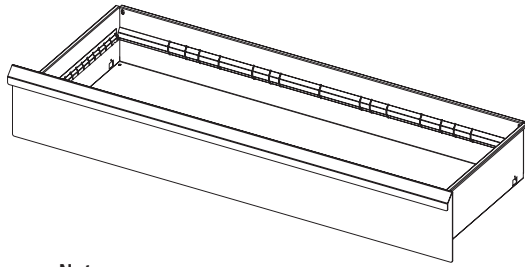

Four Steps to configuring your L&T High Density Drawer System:

1. Select the drawer width and depth (pages 94-96) that match your shelving.
2. To determine height of the drawer needed, compare the height of the item being stored with the column marked "drawer height - usable inside" (pages 94-96) and select the height that will provide you a height at least as great as the item being stored.
3. To determine the number of columns in the drawer, compare width of item being stored with the column marked "usable divider width" (pages 97-99) and select the number of columns that will provide you a width at least as great as the item being stored.
4. Add spreaders and kickplates (page 99) for added rigidity and a clean appearance. Each unit should have a minimum of 4 pairs made up of a combination of double rivet shelf supports and/or spreaders.

Note:

- Depth of drawers MUST match shelving unit.
- Dual entry access is available for 30" and 36" only. (i.e., 30" depth unit allows two 15" drawers on same level)
- Never open more than one drawer at a time.
- We strongly recommend that all shelving, especially shelving containing modular drawers, be floor or wall anchored.
- 18" Lateral drawers can accommodate both letter and legal sized files side-to-side.
- 15" Lateral drawers can only accommodate letter sized files side-to-side. For legal sized files, front-to-back cross rods (page 34) must be used.
- See supplemental brochure for possible lateral drawer configurations.

Each drawer includes:

Drawer, Mounting Brackets, Suspensions, Full Length Label Holder, Label and Clear Label Cover

15" DEEP SHELVING

*Double entry units are supplied with one suspension and one mounting bracket.

CAT. NO.	DESCRIPTION	L&T SHELVING TYPE*	DRAWER HEIGHT			INSIDE DRAWER WIDTH	INSIDE DRAWER DEPTH	WT.	PRICE
			Body	Front	Usable Inside				
B24815-30S	3" Drawer	Single Entry	2"	2 13/16"	2 1/2"	43 3/32"	13"	25.0	319.00
B24815-30D	3" Drawer	Double Entry	2"	2 13/16"	2 1/2"	43 3/32"	13"	25.0	317.00
B24815-45S	4 1/2" Drawer	Single Entry	3"	4 5/16"	3 7/8"	43 3/32"	13"	29.0	371.00
B24815-45D	4 1/2" Drawer	Double Entry	3"	4 5/16"	3 7/8"	43 3/32"	13"	29.0	371.00
B24815-60S	6" Drawer	Single Entry	4 1/2"	5 13/16"	5 1/2"	43 3/32"	13"	33.0	429.00
B24815-60D	6" Drawer	Double Entry	4 1/2"	5 13/16"	5 1/2"	43 3/32"	13"	33.0	429.00
B24815-75S	7 1/2" Drawer	Single Entry	6"	7 5/16"	7"	43 3/32"	13"	36.0	434.00
B24815-75D	7 1/2" Drawer	Double Entry	6"	7 5/16"	7"	43 3/32"	13"	36.0	434.00
B24815-90S	9" Drawer	Single Entry	7"	8 13/16"	8 1/2"	43 3/32"	13"	38.0	446.00
B24815-90D	9" Drawer	Double Entry	7"	8 13/16"	8 1/2"	43 3/32"	13"	38.0	446.00
B24815-105S	10 1/2" Drawer	Single Entry	9"	10 5/16"	10"	43 3/32"	13"	34.0	457.00
B24815-105D	10 1/2" Drawer	Double Entry	9"	10 5/16"	10"	43 3/32"	13"	34.0	457.00
B24815-120S	12" Lateral Drawer	Single Entry	9 11/16"	11 11/16"	11 7/16"	43 3/32"	13"	42.0	395.00
B24815-120D	12" Lateral Drawer	Double Entry	9 11/16"	11 11/16"	11 7/16"	43 3/32"	13"	42.0	395.00

18" DEEP SHELVING

*Double entry units are supplied with one suspension and one mounting bracket.

CAT. NO.	DESCRIPTION	L&T SHELVING TYPE*	DRAWER HEIGHT			INSIDE DRAWER WIDTH	INSIDE DRAWER DEPTH	WT.	PRICE
			Body	Front	Usable Inside				
B24818-30S	3" Drawer	Single Entry	2"	2 13/16"	2 1/2"	43 3/32"	16"	27.0	333.00
B24818-30D	3" Drawer	Double Entry	2"	2 13/16"	2 1/2"	43 3/32"	16"	27.0	332.00
B24818-45S	4 1/2" Drawer	Single Entry	3"	4 5/16"	3 7/8"	43 3/32"	16"	31.0	386.00
B24818-45D	4 1/2" Drawer	Double Entry	3"	4 5/16"	3 7/8"	43 3/32"	16"	31.0	386.00
B24818-60S	6" Drawer	Single Entry	4 1/2"	5 13/16"	5 1/2"	43 3/32"	16"	35.0	429.00
B24818-60D	6" Drawer	Double Entry	4 1/2"	5 13/16"	5 1/2"	43 3/32"	16"	35.0	429.00
B24818-75S	7 1/2" Drawer	Single Entry	6"	7 5/16"	7"	43 3/32"	16"	38.0	459.00
B24818-75D	7 1/2" Drawer	Double Entry	6"	7 5/16"	7"	43 3/32"	16"	38.0	459.00
B24818-90S	9" Drawer	Single Entry	7"	8 13/16"	8 1/2"	43 3/32"	16"	39.0	464.00
B24818-90D	9" Drawer	Double Entry	7"	8 13/16"	8 1/2"	43 3/32"	16"	39.0	464.00
B24818-105S	10 1/2" Drawer	Single Entry	9"	10 5/16"	10"	43 3/32"	16"	41.0	468.00
B24818-105D	10 1/2" Drawer	Double Entry	9"	10 5/16"	10"	43 3/32"	16"	41.0	468.00
B24818-120S	12" Lateral Drawer	Single Entry	9 11/16"	11 11/16"	11 7/16"	43 3/32"	16"	35.0	423.00
B24818-120D	12" Lateral Drawer	Double Entry	9 11/16"	11 11/16"	11 7/16"	43 3/32"	16"	35.0	423.00

24" DEEP SHELVING

CAT. NO.	DESCRIPTION	L&T SHELVING TYPE*	DRAWER HEIGHT			INSIDE DRAWER WIDTH	INSIDE DRAWER DEPTH	WT.	PRICE
			Body	Front	Usable Inside				
B24824-30S	3" Drawer	Single Entry	2"	2 13/16"	2 1/2"	43 3/32"	22"	29.0	389.00
B24824-45S	4 1/2" Drawer	Single Entry	3"	4 5/16"	3 7/8"	43 3/32"	22"	34.0	438.00
B24824-60S	6" Drawer	Single Entry	4 1/2"	5 13/16"	5 1/2"	43 3/32"	22"	38.0	495.00
B24824-75S	7 1/2" Drawer	Single Entry	6"	7 5/16"	7"	43 3/32"	22"	42.0	539.00
B24824-90S	9" Drawer	Single Entry	7"	8 13/16"	8 1/2"	43 3/32"	22"	43.0	545.00
B24824-105S	10 1/2" Drawer	Single Entry	9"	10 5/16"	10"	43 3/32"	22"	45.0	559.00

For L&T Colors [click here](#)

OR

call customer service at: (866) 446-8686

Dividers for Drawers - 8 & 6 Columns

Note:

- Dividers are flanged to accept standard label stock (not supplied).
- Dividers can be used individually as column compressors (i.e., one divider per column).
- To determine the size of divider needed, compare the width of item being stored to the column marked "usable divider width" and choose the number of columns that will give you a width at least as great as the item being stored.

FOR 8 COLUMN CONFIGURATIONS

CAT. NO.	DRAWER HEIGHT	QTY.	USABLE DIVIDER WIDTH	ACTUAL DIVIDER WIDTH	DIVIDER HEIGHT	WT.	PRICE
FOR 36" WIDE DRAWERS							
4036-830	3"	EACH	3 11/32"	3 23/32"	2 7/32"	0.1	3.00
4036-845	4 1/2"	EACH	3 11/32"	3 23/32"	2 27/32"	0.1	3.10
4036-860	6"	EACH	3 11/32"	3 23/32"	4 11/32"	0.2	3.20
4036-875	7 1/2"	EACH	3 11/32"	3 23/32"	5 27/32"	0.2	3.30
4036-890	9"	EACH	3 11/32"	3 23/32"	6 27/32"	0.2	3.40
4036-8105	10 1/2"	EACH	3 11/32"	3 23/32"	8 27/32"	0.3	3.60
FOR 42" WIDE DRAWERS							
4042-830	3"	EACH	4 1/16"	4 15/32"	2 7/32"	0.1	3.00
4042-845	4 1/2"	EACH	4 1/16"	4 15/32"	2 27/32"	0.1	3.10
4042-860	6"	EACH	4 1/16"	4 15/32"	4 11/32"	0.2	3.30
4042-875	7 1/2"	EACH	4 1/16"	4 15/32"	5 27/32"	0.3	3.50
4042-890	9"	EACH	4 1/16"	4 15/32"	6 27/32"	0.3	3.60
4042-8105	10 1/2"	EACH	4 1/16"	4 15/32"	8 27/32"	0.4	3.90
FOR 48" WIDE DRAWERS							
4048-830	3"	EACH	4 27/32"	5 7/32"	2 7/32"	0.1	3.40
4048-845	4 1/2"	EACH	4 27/32"	5 7/32"	2 27/32"	0.2	3.50
4048-860	6"	EACH	4 27/32"	5 7/32"	4 11/32"	0.2	3.70
4048-875	7 1/2"	EACH	4 27/32"	5 7/32"	5 27/32"	0.3	4.00
4048-890	9"	EACH	4 27/32"	5 7/32"	6 27/32"	0.3	4.10
4048-8105	10 1/2"	EACH	4 27/32"	5 7/32"	8 27/32"	0.4	4.40

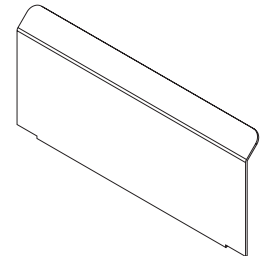

Note:

- Dividers are flanged to accept standard label stock (not supplied).
- Dividers can be used individually as column compressors (i.e., one divider per column).
- To determine the size of divider needed, compare the width of item being stored to the column marked "usable divider width" and choose the number of columns that will give you a width at least as great as the item being stored.

FOR 6 COLUMN CONFIGURATIONS

CAT. NO.	DRAWER HEIGHT	QTY.	USABLE DIVIDER WIDTH	ACTUAL DIVIDER WIDTH	DIVIDER HEIGHT	WT.	PRICE
FOR 36" WIDE DRAWERS							
4036-630	3"	EACH	4 21/32"	5 1/32"	2 7/32"	0.1	3.20
4036-645	4 1/2"	EACH	4 21/32"	5 1/32"	2 27/32"	0.1	3.30
4036-660	6"	EACH	4 21/32"	5 1/32"	4 11/32"	0.2	3.50
4036-675	7 1/2"	EACH	4 21/32"	5 1/32"	5 27/32"	0.3	3.70
4036-690	9"	EACH	4 21/32"	5 1/32"	6 27/32"	0.3	3.90
4036-6105	10 1/2"	EACH	4 21/32"	5 1/32"	8 27/32"	0.4	4.10
FOR 42" WIDE DRAWERS							
4042-630	3"	EACH	5 5/8"	6 1/6"	2 7/32"	0.1	3.30
4042-645	4 1/2"	EACH	5 5/8"	6 1/6"	2 27/32"	0.2	3.40
4042-660	6"	EACH	5 5/8"	6 1/6"	4 11/32"	0.3	3.60
4042-675	7 1/2"	EACH	5 5/8"	6 1/6"	5 27/32"	0.3	4.00
4042-690	9"	EACH	5 5/8"	6 1/6"	6 27/32"	0.4	4.10
4042-6105	10 1/2"	EACH	5 5/8"	6 1/6"	8 27/32"	0.5	4.40
FOR 48" WIDE DRAWERS							
4048-630	3"	EACH	6 11/16"	7 1/32"	2 7/32"	0.1	3.90
4048-645	4 1/2"	EACH	6 11/16"	7 1/32"	2 27/32"	0.2	4.10
4048-660	6"	EACH	6 11/16"	7 1/32"	4 11/32"	0.3	4.30
4048-675	7 1/2"	EACH	6 11/16"	7 1/32"	5 27/32"	0.4	4.60
4048-690	9"	EACH	6 11/16"	7 1/32"	6 27/32"	0.5	4.70
4048-6105	10 1/2"	EACH	6 11/16"	7 1/32"	8 27/32"	0.6	5.10

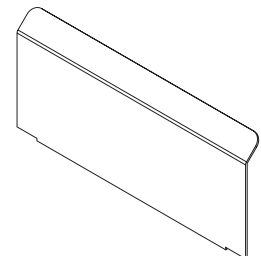

For L&T Colors [click here](#)
 OR
 call customer service at: (866) 446-8686

Dividers for Drawers - 5 & 4 Columns

Note:

- Dividers are flanged to accept standard label stock (not supplied).
- Dividers can be used individually as column compressors (i.e., one divider per column).
- To determine the size of divider needed, compare the width of item being stored to the column marked "usable divider width" and choose the number of columns that will give you a width at least as great as the item being stored.

FOR 5 COLUMN CONFIGURATIONS

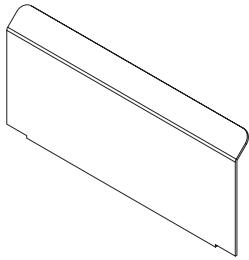

CAT. NO.	DRAWER HEIGHT	QTY.	USABLE DIVIDER WIDTH	ACTUAL DIVIDER WIDTH	DIVIDER HEIGHT	WT.	PRICE
FOR 36" WIDE DRAWERS							
4036-530	3"	EACH	5 11/16"	6 1/16"	2 7/32"	0.1	3.40
4036-545	4 1/2"	EACH	5 11/16"	6 1/16"	2 27/32"	0.2	3.60
4036-560	6"	EACH	5 11/16"	6 1/16"	4 11/32"	0.3	3.90
4036-575	7 1/2"	EACH	5 11/16"	6 1/16"	5 27/32"	0.3	4.10
4036-590	9"	EACH	5 11/16"	6 1/16"	6 27/32"	0.4	4.30
4036-5105	10 1/2"	EACH	5 11/16"	6 1/16"	8 27/32"	0.5	4.50
FOR 42" WIDE DRAWERS							
4042-530	3"	EACH	6 15/16"	7 9/32"	2 7/32"	0.2	3.90
4042-545	4 1/2"	EACH	6 15/16"	7 9/32"	2 27/32"	0.2	4.10
4042-560	6"	EACH	6 15/16"	7 9/32"	4 11/32"	0.3	4.30
4042-575	7 1/2"	EACH	6 15/16"	7 9/32"	5 27/32"	0.4	4.60
4042-590	9"	EACH	6 15/16"	7 9/32"	6 27/32"	0.5	4.80
4042-5105	10 1/2"	EACH	6 15/16"	7 9/32"	8 27/32"	0.6	5.10
FOR 48" WIDE DRAWERS							
4048-530	3"	EACH	8 1/8"	8 1/2"	2 7/32"	0.2	4.00
4048-545	4 1/2"	EACH	8 1/8"	8 1/2"	2 27/32"	0.2	4.20
4048-560	6"	EACH	8 1/8"	8 1/2"	4 11/32"	0.4	4.40
4048-575	7 1/2"	EACH	8 1/8"	8 1/2"	5 27/32"	0.5	4.80
4048-590	9"	EACH	8 1/8"	8 1/2"	6 27/32"	0.5	5.00
4048-5105	10 1/2"	EACH	8 1/8"	8 1/2"	8 27/32"	0.7	5.50

Note:

- Dividers are flanged to accept standard label stock (not supplied).
- Dividers can be used individually as column compressors (i.e., one divider per column).
- To determine the size of divider needed, compare the width of item being stored to the column marked "usable divider width" and choose the number of columns that will give you a width at least as great as the item being stored.

FOR 4 COLUMN CONFIGURATIONS

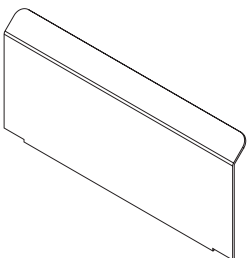

CAT. NO.	DRAWER HEIGHT	QTY.	USABLE DIVIDER WIDTH	ACTUAL DIVIDER WIDTH	DIVIDER HEIGHT	WT.	PRICE
FOR 36" WIDE DRAWERS							
4036-430	3"	EACH	7 9/32"	7 11/16"	2 7/32"	0.2	3.90
4036-445	4 1/2"	EACH	7 9/32"	7 11/16"	2 27/32"	0.2	4.10
4036-460	6"	EACH	7 9/32"	7 11/16"	4 11/32"	0.3	4.30
4036-475	7 1/2"	EACH	7 9/32"	7 11/16"	5 27/32"	0.4	4.70
4036-490	9"	EACH	7 9/32"	7 11/16"	6 27/32"	0.5	4.90
4036-4105	10 1/2"	EACH	7 9/32"	7 11/16"	8 27/32"	0.6	5.20
FOR 42" WIDE DRAWERS							
4042-430	3"	EACH	8 25/32"	9 3/16"	2 7/32"	0.2	4.00
4042-445	4 1/2"	EACH	8 25/32"	9 3/16"	2 27/32"	0.3	4.20
4042-460	6"	EACH	8 25/32"	9 3/16"	4 11/32"	0.4	4.50
4042-475	7 1/2"	EACH	8 25/32"	9 3/16"	5 27/32"	0.5	4.90
4042-490	9"	EACH	8 25/32"	9 3/16"	6 27/32"	0.6	5.10
4042-4105	10 1/2"	EACH	8 25/32"	9 3/16"	8 27/32"	0.7	5.60
FOR 48" WIDE DRAWERS							
4048-430	3"	EACH	10 5/16"	10 11/16"	2 7/32"	0.2	4.40
4048-445	4 1/2"	EACH	10 5/16"	10 11/16"	2 27/32"	0.3	4.60
4048-460	6"	EACH	10 5/16"	10 11/16"	4 11/32"	0.4	5.00
4048-475	7 1/2"	EACH	10 5/16"	10 11/16"	5 27/32"	0.6	5.50
4048-490	9"	EACH	10 5/16"	10 11/16"	6 27/32"	0.7	5.80
4048-4105	10 1/2"	EACH	10 5/16"	10 11/16"	8 27/32"	0.9	6.30

For L&T Colors [click here](#)

OR

call customer service at: (866) 446-8686

Dividers for Drawers, Accessories

FOR 3 COLUMN CONFIGURATION

CAT. NO.	DRAWER HEIGHT	QTY.	USABLE DIVIDER WIDTH	ACTUAL DIVIDER WIDTH	DIVIDER HEIGHT	WT.	PRICE
FOR 36" WIDE DRAWERS							
4036-330	3"	EACH	9 15/16"	10 5/16"	2 7/32"	0.2	4.10
4036-345	4 1/2"	EACH	9 15/16"	10 5/16"	2 27/32"	0.3	4.30
4036-360	6"	EACH	9 15/16"	10 5/16"	4 11/32"	0.4	4.70
4036-375	7 1/2"	EACH	9 15/16"	10 5/16"	5 27/32"	0.6	5.10
4036-390	9"	EACH	9 15/16"	10 5/16"	6 27/32"	0.7	5.40
4036-3105	10 1/2"	EACH	9 15/16"	10 5/16"	8 27/32"	0.8	5.90
FOR 42" WIDE DRAWERS							
4042-330	3"	EACH	11 15/16"	12 11/32"	2 7/32"	0.3	5.50
4042-345	4 1/2"	EACH	11 15/16"	12 11/32"	2 27/32"	0.4	5.80
4042-360	6"	EACH	11 15/16"	12 11/32"	4 11/32"	0.5	6.20
4042-375	7 1/2"	EACH	11 15/16"	12 11/32"	5 27/32"	0.7	6.70
4042-390	9"	EACH	11 15/16"	12 11/32"	6 27/32"	0.8	7.10
4042-3105	10 1/2"	EACH	11 15/16"	12 11/32"	8 27/32"	1.0	8.10
FOR 48" WIDE DRAWERS							
4048-330	3"	EACH	13 15/16"	14 5/16"	2 7/32"	0.3	5.20
4048-345	4 1/2"	EACH	13 15/16"	14 5/16"	2 27/32"	0.4	5.60
4048-360	6"	EACH	13 15/16"	14 5/16"	4 11/32"	0.6	6.10
4048-375	7 1/2"	EACH	13 15/16"	14 5/16"	5 27/32"	0.8	6.70
4048-390	9"	EACH	13 15/16"	14 5/16"	6 27/32"	0.9	7.10
4048-3105	10 1/2"	EACH	13 15/16"	14 5/16"	8 27/32"	1.2	7.80

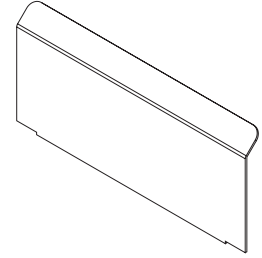

Note:

- Dividers are flanged to accept standard label stock (not supplied).
- Dividers can be used individually as column compressors (i.e., one divider per column).
- To determine the size of divider needed, compare the width of item being stored to the column marked "usable divider width" and choose the number of columns that will give you a width at least as great as the item being stored.

CAT. NO.	QTY.	DESCRIPTION	W	D	H	WT.	PRICE
FOR 36" WIDE DRAWERS							
TLT3680A	PAIR	KICKPLATE SPREADER	36	3/4"	4"	9.2	46.00
TLT3680	PAIR	UNIVERSAL SPREADER	36	3/4"	3"	8.4	33.00
FOR 42" WIDE DRAWERS							
TLT4280A	PAIR	KICKPLATE SPREADER	42	3/4"	4"	10.7	49.00
TLT4280	PAIR	UNIVERSAL SPREADER	42	3/4"	3"	9.2	41.00
FOR 48" WIDE DRAWERS							
TLT4880A	PAIR	KICKPLATE SPREADER	48	3/4"	4"	8.4	54.00
TLT4880	PAIR	UNIVERSAL SPREADER	48	3/4"	3"	11.2	43.00

SPREADERS



Note:

- Adds extra support to drawer to keep units square.
- Both kickplate and intermediate spreader are required after combination of drawers exceeds 36" in height. The # of spreaders required depends on the # of drawers used.

- When placing a shelf on top of an intermediate spreader, shelf dividers cannot be used. For dividers you may use TS shelf support above all drawers except the 3" drawer.
- Units must have a minimum of 4 pair of a combination of double rivet shelf supports and/or spreaders.
- You may use SHS at bottom of unit to attach to mobile but you will have a 1 1/8" gap to the bottom of the drawer. Also, using a pair of SHS's at the bottom does not count toward the requirement of 4 pair of left to right supports.

CAT. NO.	QTY.	DESCRIPTION	D	H	WT.	PRICE
FOR 15" DEEP DRAWERS						
4040-1530	EACH	FOR 3" HIGH DRAWER	13 3/8"	1 7/8"	1.1	22.00
4040-1545	EACH	FOR 4 1/2" HIGH DRAWER	13 3/8"	2 7/8"	1.5	16.70
4040-1560	EACH	FOR 6" HIGH DRAWER	13 3/8"	4 3/8"	2.5	21.00
4040-1575	EACH	FOR 7 1/2" HIGH DRAWER	13 3/8"	5 7/8"	2.9	21.00
4040-1590	EACH	FOR 9" HIGH DRAWER	13 3/8"	6 7/8"	3.5	21.00
4040-15105	EACH	FOR 10 1/2" HIGH DRAWER	13 3/8"	8 7/8"	4.1	21.00
FOR 18" DEEP DRAWERS						
4040-1830	EACH	FOR 3" HIGH DRAWER	13 3/8"	1 7/8"	1.3	19.60
4040-1845	EACH	FOR 4 1/2" HIGH DRAWER	13 3/8"	2 7/8"	1.8	27.00
4040-1860	EACH	FOR 6" HIGH DRAWER	13 3/8"	4 3/8"	3.0	27.00
4040-1875	EACH	FOR 7 1/2" HIGH DRAWER	13 3/8"	5 7/8"	3.5	29.00
4040-1890	EACH	FOR 9" HIGH DRAWER	13 3/8"	6 7/8"	4.2	30.00
4040-18105	EACH	FOR 10 1/2" HIGH DRAWER	13 3/8"	8 7/8"	4.9	33.00
FOR 24" DEEP DRAWERS						
4040-2430	EACH	FOR 3" HIGH DRAWER	13 3/8"	1 7/8"	2.2	25.00
4040-2445	EACH	FOR 4 1/2" HIGH DRAWER	13 3/8"	2 7/8"	2.7	28.00
4040-2460	EACH	FOR 6" HIGH DRAWER	13 3/8"	4 3/8"	4.1	32.00
4040-2475	EACH	FOR 7 1/2" HIGH DRAWER	13 3/8"	5 7/8"	4.6	34.00
4040-2490	EACH	FOR 9" HIGH DRAWER	13 3/8"	6 7/8"	5.5	35.00
4040-24105	EACH	FOR 10 1/2" HIGH DRAWER	13 3/8"	8 7/8"	6.4	40.00

PARTITIONS

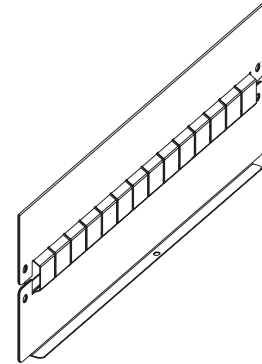

Note:

- Partitions run front to back.
- Partitions are used to divide drawer into columns.

CAT. NO.	QTY.	WT.	PRICE	CAT. NO.	QTY.	WT.	PRICE
FRONT-TO-BACK CROSS RODS (FOR 15" DRAWERS)				SIDE-TO-SIDE HANGING RODS (FOR 36" WIDE DRAWERS)			
12CR	PAIR	1.0	13.60	34HF	PAIR	2.5	8.60
FRONT-TO-BACK CROSS RODS (FOR 18" DRAWERS)				LOCKS* (Add "L" Suffix to Model Number)			
15CR	PAIR	1.0	9.30	L	EACH	0.5	58.00

ACCESSORIES

- *Note: Locks not available for 3" and 4 1/2" drawers. Locks are factory installed only and can not be added in the field.

For L&T Colors [click here](#)
OR
call customer service at: (866) 446-8686



Mailing Address: P.O. Box 1888, Dickson, TN 37056-1888

Customer Service: (866) 446-8686 • **Fax:** (866) 445-7260 | **Ordering Fax:** (866) 864-4796 | www.tennsco.com • info@tennsco.com

